

Model of Mitogen Activated Protein Kinases for Cell Survival/Death and its Equivalent Bio-circuit

¹Shruti Jain, ¹Sunil V. Bhooshan and ²Pradeep K. Naik

¹Department of Electronics and Communication Engineering

²Department of Bioinformatics and Biotechnology, Jaypee University of Information Technology, Wanknaghat, Solan 173215, Himachal Pradesh, India.

Abstract: Cell proliferation, differentiation and programmed cell death (apoptosis) are tightly regulated in healthy tissues by a variety of external signals working via receptors that activate intracellular signal transduction pathways. Combining engineering analyses and mathematical modeling with intervention and detection methodologies at the molecular level will allow manipulation of intracellular signal transduction pathways and therefore rational control of functional processes central to medicine and biotechnology. We have made computational model for mitogen-activated protein kinase (MAPK), on the basis of that model we have made the truth tables, Boolean equations and then implement the equations using logic circuits and Bio-circuits showing cell survival and death.

Key words: Mitogen-activated protein kinase, extracellular-regulated kinase, Jun N-terminal kinases and mitogen- activated protein kinase-activated protein kinase 2

INTRODUCTION

Mitogen-activated protein kinase dual-specificity phosphatase-1 (also called MKP-1, DUSP1, ERP, CL100, HVH1, PTPN10 and 3CH134) is a member of the threonine-tyrosine dual-specificity phosphatases, one of more than 100 protein tyrosine phosphatases (Pearson *et al.*, 2001; Schlessinger, 2000). MAP kinases are actually a family of protein kinases that are widely distributed and are found in all eukaryotic organisms. These can be classified into three main functional groups (Dudley *et al.*, 1995; Zhou *et al.*, 1995) as shown in Fig. 1. The first is mediated by mitogenic and differentiation signals. The other two respond to stress and inflammatory cytokines. The ERK pathway responds to mitogen activation. In the JNK/SAPK pathway SAPK stands for stress activation protein kinase and within this class of kinases the Jun N-terminal kinases (JNK) are a subfamily. In the p38/HOG pathway HOG stands for high osmolarity glycerol where the p38 proteins are a subfamily. Each of these pathways led to the dual phosphorylation of MAP kinase family members responsible for activation of transcription factors. Cytokines and growth factors activate the mitogen-activated protein (MAP) kinase pathways resulting in the stimulation of ERK1/2, c-Jun N-terminal kinases and p38 kinases which in turn activate transcription factors like AP-1 and ATF-2. Other proinflammatory agents like TNF- α , IL-1 and LPS activate the transcription factor NF- κ B which participates in the regulation of expression of immediate early genes

involved in immune, acute phase and inflammatory responses. Besides the transcription factors NF- κ B and AP-1 which are immediate-early transcriptional activators, components of the JAK/STAT pathway play an important role in the transcriptional activation of many inflammatory genes. Consensus sequences for the transcription factors NF- κ B, AP-1 and STAT1a have been found in the promoters of COX-2 and iNOS.

System Modeling of Cell Survival/Death: Various protein networks were reported for the regulation of cell survival/death including MAPKs. The MAPKs consist of several subfamilies such as ERK, JNK/SAPK (c-Jun amino-terminal kinase/stress-activated protein kinase), and p38/ MK2. They act in distinct and independent signaling pathways with a wide range of cellular responses including proliferation, differentiation and survival (Cross *et al.*, 2000). The important pro-survival and mitogenic pathways activated by the EGFR/ IGF1R include signaling through a MAPK, p42/p44 extracellular signal-related kinases, ERK 1 and 2 (Boulton *et al.*, 1991). The signaling through ERK 1 and 2 has a major role in the stimulation of cell proliferation; they have been shown to be translocated to the nucleus and induce gene expression that promotes the cell cycle entry (Greulich *et al.*, 1998). There is evidence of direct regulation of apoptosis by ERK (downstream of b-Raf) through cytosolic caspase inhibition (Erhardt *et al.*, 1999).

The other MAPK members, p38 and JNK/SAPK represent signaling pathways homologous to the Ras-

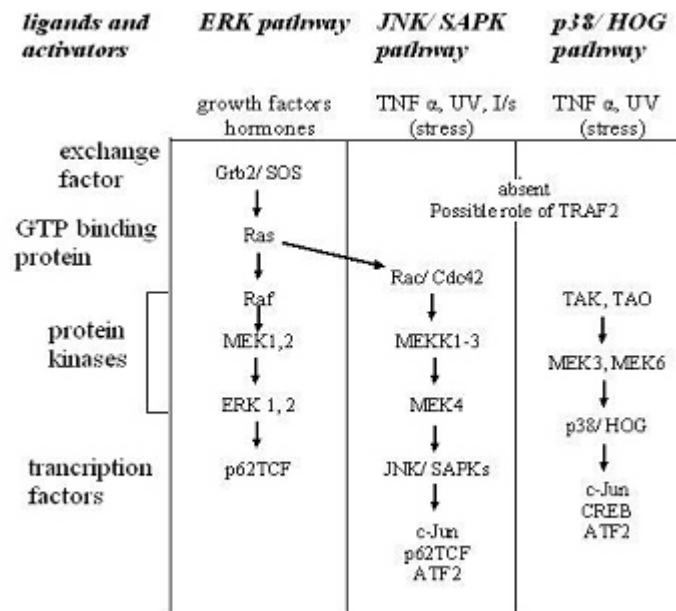

Fig. 1: Three main functional groups of MAP kinases

MAPK pathways, which are involved in the regulation of cellular responses to stress (Kyriakis *et al.*, 1996). These pathways, in contrast, are not activated primarily by mitogens, but instead by various kinds of cellular stress and inflammatory cytokines, and result in apoptosis (Kyriakis *et al.*, 1996).

The RAS/ERK pathway: Growth factor stimulation activates various signaling pathways that result in the induction of a variety of genes involved in the regulation of cell proliferation, cell differentiation and cell cycle progression. The ERK MAP kinase cascade is one of the central pathways in growth factor signal transductions. In response to growth factor stimulation, classical MAP kinase kinase MEK becomes activated, and then the activated MEK phosphorylates and activates classical MAP kinase ERK. EGF/IRS activates the ERK pathway through the binding of Grb2 or Shc to phosphorylated ErbB receptors, which in turn results in the recruitment of the son of sevenless (SOS) to the activated receptor dimer. SOS then activates RAS leading to the activation of RAF 1 (Hallberg *et al.*, 1994; Evers *et al.*, 1998). RAF-1 subsequently phosphorylates MEK1 and MEK2 which activate respectively ERK1 and ERK2. The MAP kinases (MAPKs) are serine/ threonine protein kinases e.g. ERK1/2 (extracellular signal-related kinase 1/2), which are activated by MAP/ERK kinases (MEKs), which in turn is activated by MEK kinase (MEKK), such as Raf. This pathway results in cell proliferation and in the increased transcription of Bcl2 family members and inhibitors of apoptosis proteins (IAPs), thereby promoting cell survival. Mitogenic signalling increases the rate of

translation of selective mRNAs. ERK plays a role in initiating protein synthesis by phosphorylating Mnk1 which results in the removal of secondary structure at the initiation site for protein synthesis. Mnk1 is also the target for some viruses when hijacking cellular protein synthesis. For example, adenovirus protein p100 binds eIFG and displaces Mnk1 so that it is no longer able to activate eIF-4E. As a result, cellular mRNA remains untranslated while viral mRNA is unaffected and, as a result, the cell switches to the manufacture of viral proteins.

JNK pathway: The second most widely studied MAP kinase cascade is the JNK/SAPK (c-Jun NH₂-terminal kinase/stress activated protein kinase). The c-Jun kinase (JNK) is activated when cells are exposed to ultraviolet (UV) radiation, heat shock, or inflammatory cytokines. However, the functional consequence of JNK activation in UV-irradiated cells has not been established. It is shown here that JNK is required for UV-induced apoptosis in primary murine embryonic fibroblasts. Fibroblasts with simultaneous targeted disruptions of all the functional *Jnk* genes were protected against UV-stimulated apoptosis. The absence of JNK caused a defect in the mitochondrial death signaling pathway, including the failure to release cytochrome c. These data indicate that mitochondria are influenced by proapoptotic signal transduction through the JNK pathway. The activation of these MAP kinases is mediated by Rac and cdc42, two small G-proteins. The activated cdc42 binds to PAK65 protein kinase and activates it. The activated PAK65 can activate MEKK, which in turn phosphorylates SEK/JNKK

and activates it. The active SEK/JNKK phosphorylates JNK/SAPK (at the TPY motif) that in turn binds to the N-terminal region of c-Jun and phosphorylates it as shown in Eq. 1.

p38 pathway: The p38 kinase is the most well-characterized member of the MAP kinase family. It is activated in response to inflammatory cytokines, endotoxins, and osmotic stress. It shares about 50% homology with the ERKs. The upstream steps in its activation of this cascade are not well defined. However, downstream activation of p38 occurs following its phosphorylation (at the TGY motif) by MKK3, a dual specificity kinase. Following its activation, p38 translocates to the nucleus and phosphorylates ATF-2. Another known target of p38 is MAPK2 that is involved in the phosphorylation and activation of heat-shock proteins.

Although different MAP kinase cascades show high degree of specificity and functional separation, some degree of cross-talk is observed between different pathways. For example, JNKK, an activator of JNK/SAPK, is reported to activate p38, whereas MKK3 activates only p38 and not JNK/SAPK. MEKK1 that stimulates SEK/JNKK1 in the JNK/SAPK cascade has only a trivial effect on p38 activation. In the upstream signaling, SOS stimulates only the ERK pathways without affecting either JNK or p38 cascade. Another important observation is that if mammalian cells are treated with mitogenic agents; ERKs are significantly activated whereas JNK/SAPK are not affected. Conversely, cells exposed to stress cells activate JNK/SAPK pathway without altering the activity of ERKs. At the transcription level, ATF-2 is phosphorylated and activated by all three MAP kinases, whereas c-Jun and Elk-1 are phosphorylated by ERKs and JNK/SAPK, yet all these pathways result in transcriptional activity that is unique for a particular external stress.

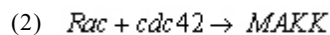
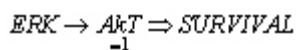
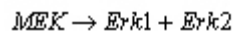
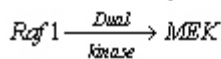
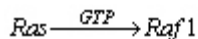
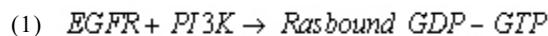
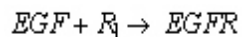

(two small G proteins)

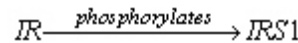
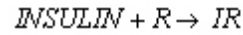
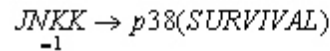
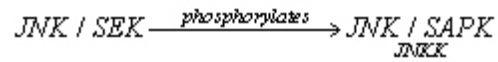
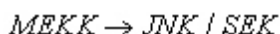
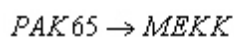
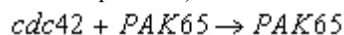

(1)

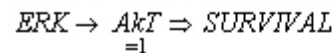
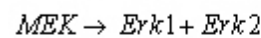
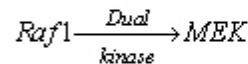
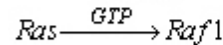
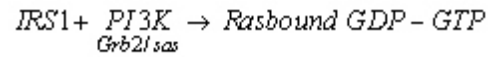

(2)

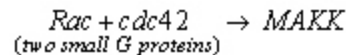

(two small G proteins)

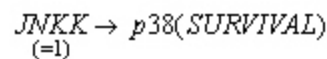
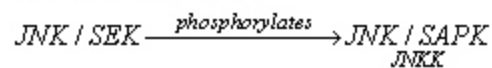
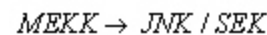
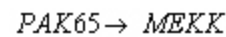
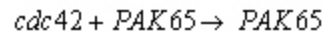

RESULTS AND DISCUSSION

Experimental findings: The experimental findings of cell survival or cell death with respect to cytokine treatments was conducted by Gaudet *et al.* (2005) and Janes *et al.* (2005). Each treatment consisted of a combination of TNF and either EGF or insulin. Cells respond to TNF, EGF, and insulin in a dose-dependent manner and all three cytokines were therefore examined at sub saturating concentrations, designed to mimic physiological conditions, and at saturating concentrations, at which essentially all receptors were ligand-bound. All together, ERK, JNK and MK2 signals were examined. Kinases such as Akt and ERK were maximally active 5-15 min after cytokine addition whereas caspase cleavage was evident only after 4 h time shown in Table 1.

Based on the heat map (Fig. 3) from Gaudet *et al.* (2005), the respective time dependent signals of ERK pathway in cells have been elucidated (Fig. 3). For each treatment, the average signal intensities were normalized to the maximal value obtained for that signal (1: green; 0: red) and are plotted for the 13 time points. Fig. 4 and 5a to j shows the heat map and corresponding graph of time-dependent signals for JNK and MK2 respectively using TNF/EGF/Insulin combination of 0/0/0 ng/ml with (0, 5, 15, 30, 60, 90, 120 min) and then (4, 8, 12, 16, 20, 24 h).

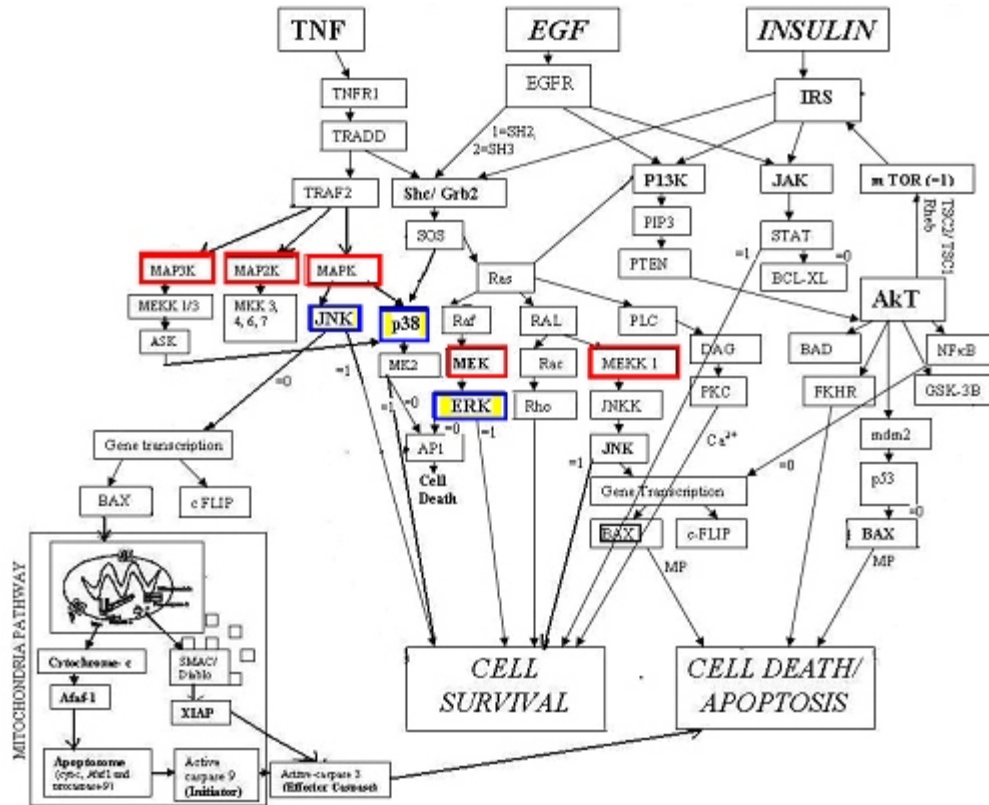

Fig. 2: Block diagram of cell survival and cell death

Table 1: Combination of ten cytokine treatments used in the experimental study (Gaudet et al. 2005)

	(a)	(b)	(c)	(d)	(e)	(f)	(g)	(h)	(i)	(j)
TNF(ng/ml)	-	5	100	-	5	100	-	0.2	5	100
EGF(ng/ml)	-	-	100	100	110	0	-	-	-	-
Insulin(ng/ml)	-	-	-	-	-	-	500	1	5	500

Compendium Model: On the basis of block diagram (Fig. 2) we have made truth tables of every possible path culminate in cell death/ survival of individual inputs i.e. TNF, EGF and Insulin. Then we realize the truth tables by Karnaugh Map (K-Map) and get the expression for each input and its individual possible paths. With the help of Boolean equations we have implemented circuits using Logic gates. Logic gates are the basic building blocks in electronic circuits that perform logical operations. These have input and output signals in the form of 0's and 1's; '0' signifies the absence of signal while '1' signifies its presence. Similar to the electronic logic gates, cellular components can serve as logic gates. A typical biological circuit consists of (i) a coding region, (ii) its promoter, (iii) RNA polymerase and the (iv) regulatory proteins with their v) DNA binding elements, and vi) small signaling molecules that interact with the regulatory proteins (Weiss *et al.*, 2002; 2003). There are three steps in a simple gate: (i) Translation of the input mRNA signal, (ii) cooperative binding of the protein (repressor) to the DNA (operator) and (iii) regulated gene expression to generate the output

signal. Therefore, the output signal is influenced by the amino acid synthesis occurring in the cell, the affinities of the ribosome binding sites on the mRNA and its stability. Other factors like dimerization of the repressor proteins and the affinities to their respective operators also play a role in determining the amount of the output signal. Messenger RNA or their translation products can serve as input and output signals to the logic gates formed by genes with which these gene products interact. The concentration of the gene product determines the strength of the signal. High concentration indicates the presence of signal (=1) i.e. survival whereas low concentration indicates its absence (=0) i.e., death.

The NOT Gate: The NOT gate is the simplest biochemical circuit. The gate has a single input signal. The NOT gate 'inverts' the input signal, hence known as the inverter gate shown in Fig. 6. The enzyme RNA polymerase binds to DNA elements called promoters to carry out transcription (the conversion of the information in DNA to an intermediate, mRNA). The gate is used to determine the intracellular state of the cell.

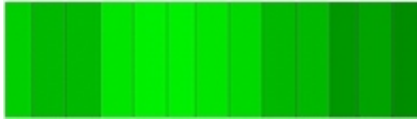

Time/ Normalized Value[0-0-0]

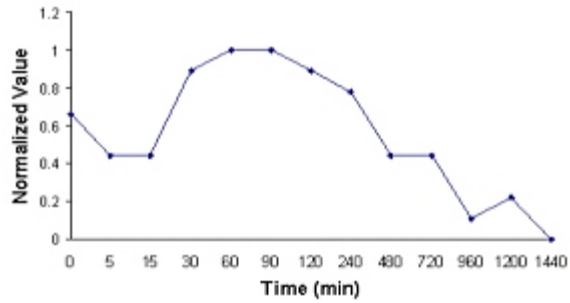

(a)



Time/Normalized Value [0-100-0]

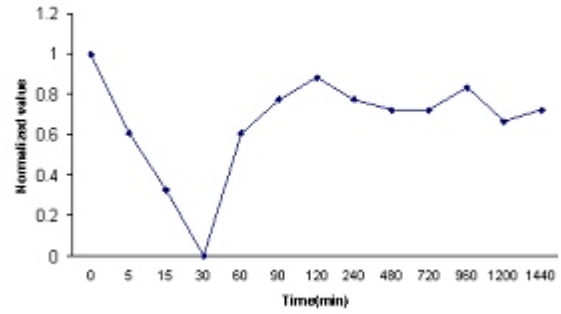

(d)



Time/ Normalized Value [5-0-0]

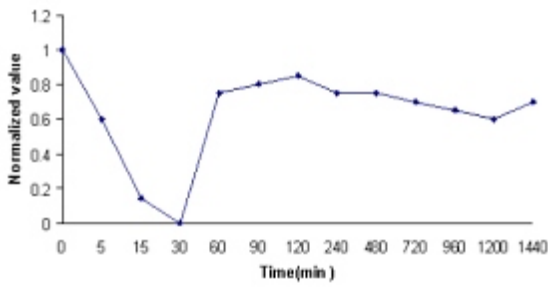

(b)



Time/Normalized Value [5-1-0]

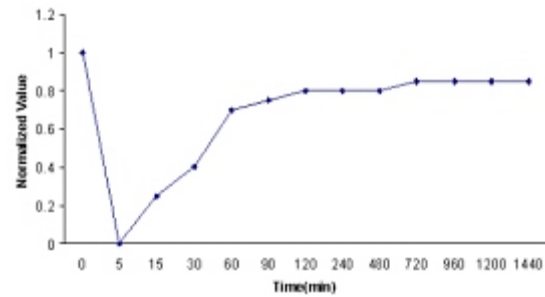

(e)



Time/Normalized Value [100-0-0]

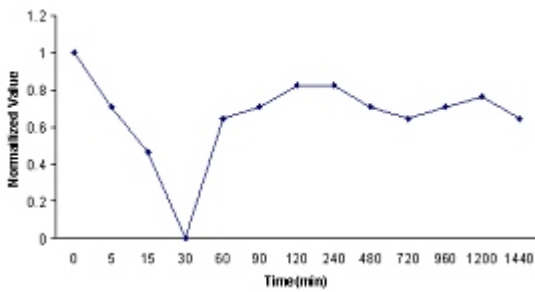

(c)

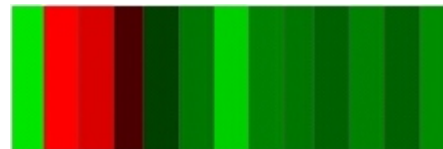

Time/Normalized Value [100-100-0]

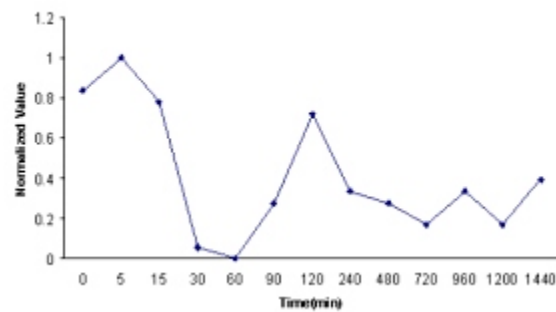

(f)

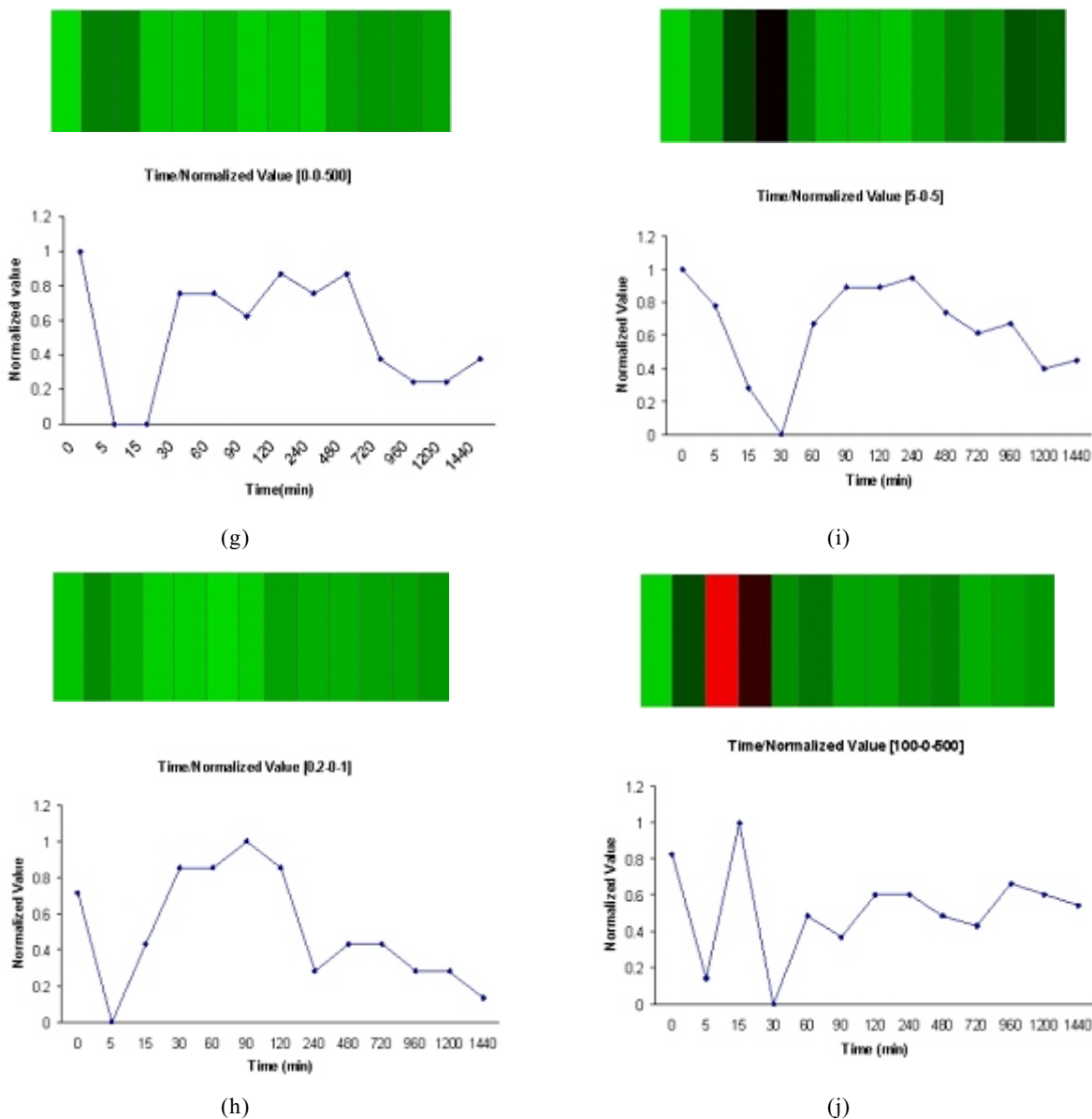

Fig. 3: Heat map and corresponding graph of time-dependent signals in cells treated with 10 cytokine combinations of ERK. For each treatment, the average signal intensities were normalized to the maximal value obtained for that signal and are plotted for the 13 time points

The AND Gate: The AND gate has two input signals and only when both the signals are present, an output signal is generated shown in Fig. 7. The polymerase intrinsically has low affinity for promoters, hence there is no transcription. The activator and inducer together result in turning on a gene. The gate can be used for cell-cell communication.

Biocomputing, as the name suggests, is computation performed using biomolecules such as DNA and proteins. A biological process such as glycolysis or bioluminescence can be viewed as a genetic regulatory circuit. A genetic regulatory circuit is a complex set of biochemical reactions that regulates the behavior and

function of genes, operons, DNA, RNA and proteins. The NOT gate is built using two promoter/repressor pairs. The inducer input is applied to the first promoter/repressor pair (P1/R1). The output protein produced by the first repressor/promoter pair acts as the repressor (R2) to the second promoter (P2). Hence, whenever the inducer input is introduced, the second promoter is repressed and no output is produced. When no inducer input is present, then the second promoter will produce the output protein. The AND gate can be built using a single repressor/promoter pair which is activated using two inducers. Both the inducers have to be present to activate the output protein production.



Time/Normalized Value 0-0-0

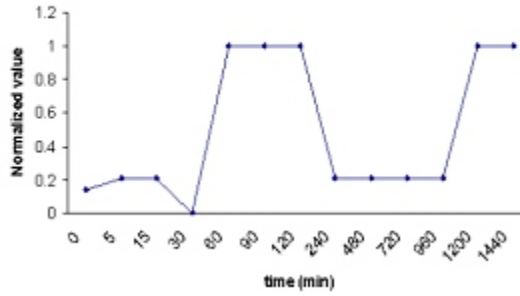

(a)

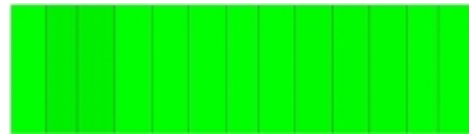

Time/Normalized Value 0-100-0

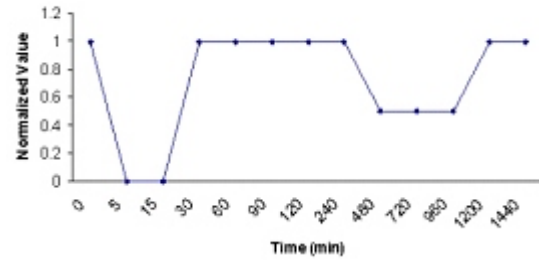

(d)



Time/Normalized Value 5-0-0

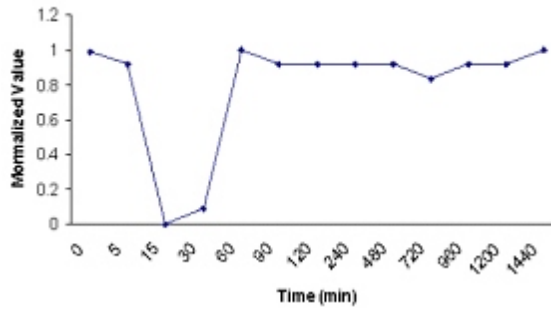

(b)

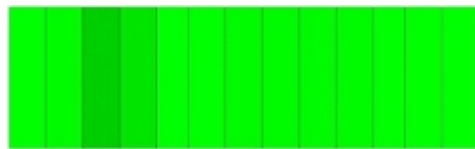

Time/Normalized Value 5-1-0

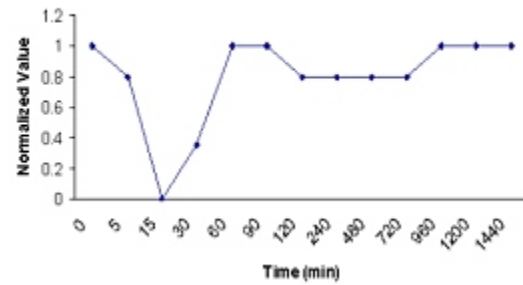

(c)



Time/Normalized Value 100-0-0

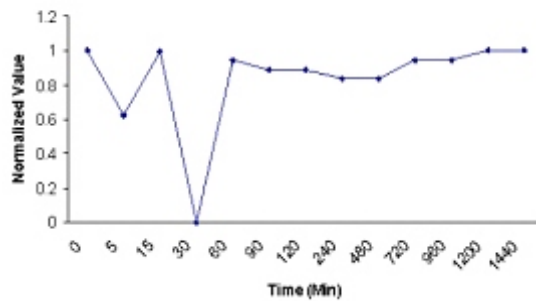

(c)



Time/Normalized Value 100-100-0

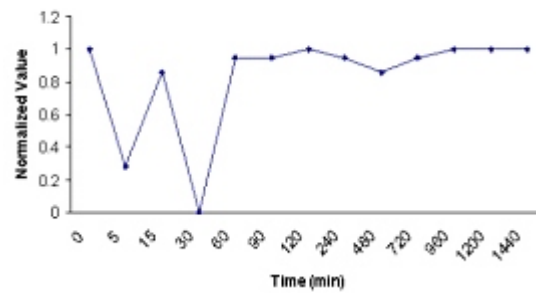

(f)

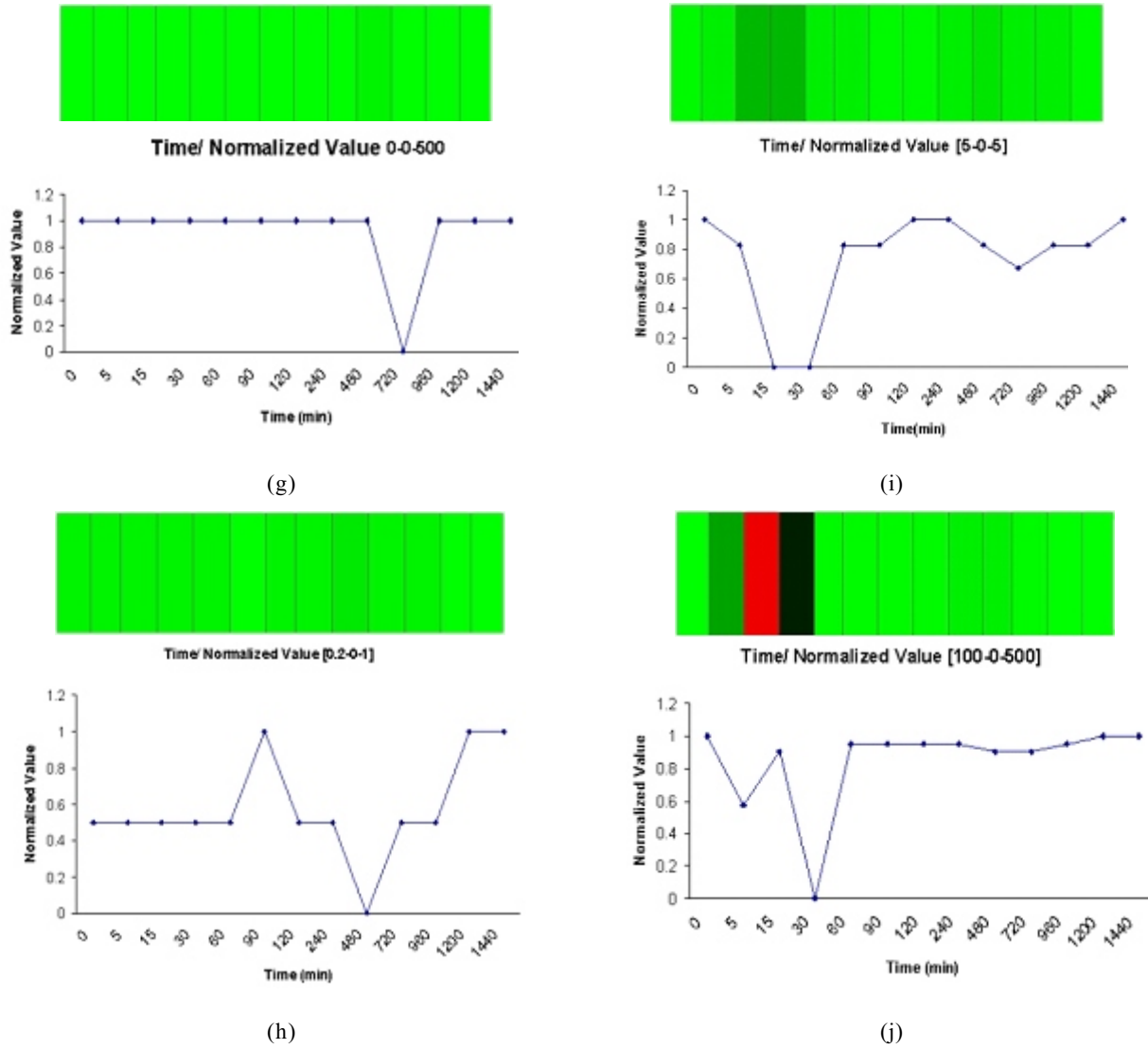
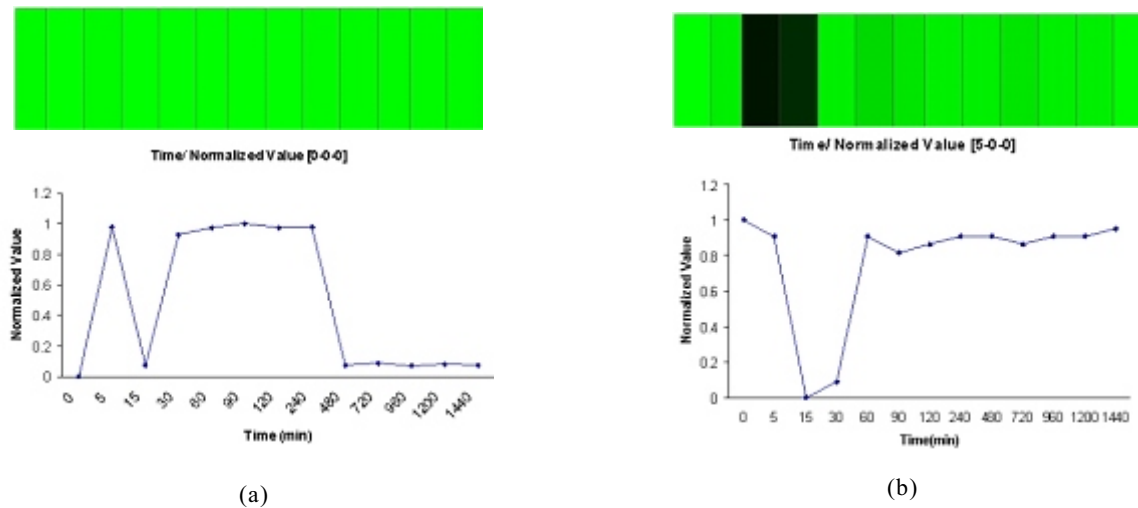
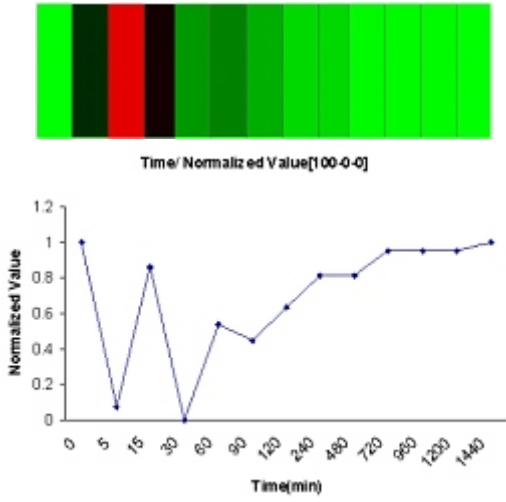
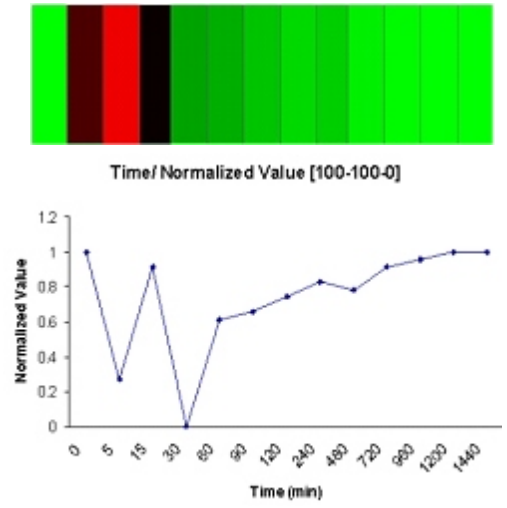

Fig. 4: Heat map and corresponding graph of time-dependent signals in cells treated with 10 cytokine combinations of JNK. For each treatment, the average signal intensities were normalized to the maximal value obtained for that signal and are plotted for the 13 time points.





(c)



(f)

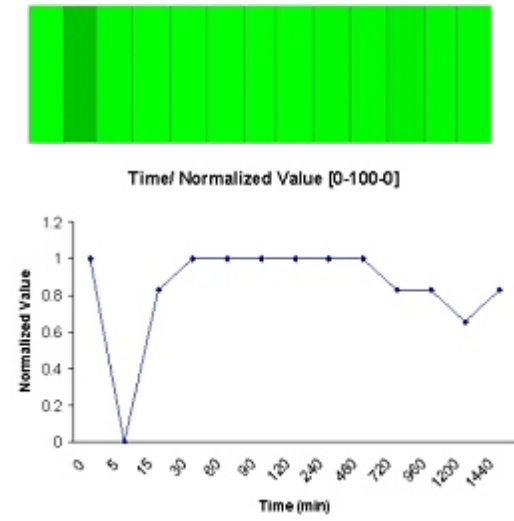

(d)

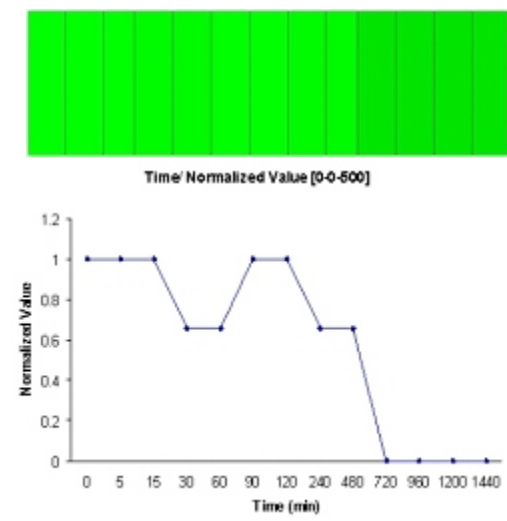

(g)

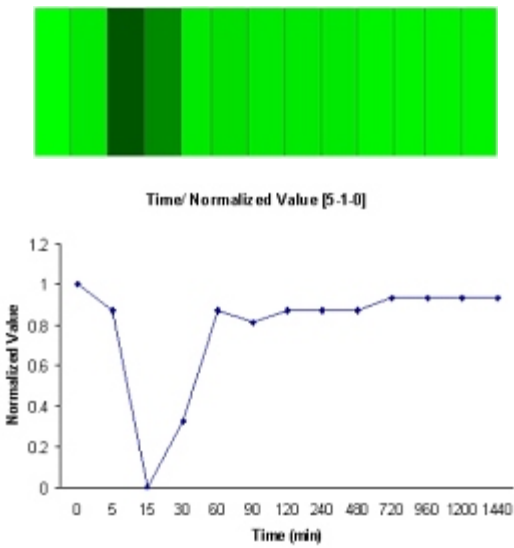

(e)

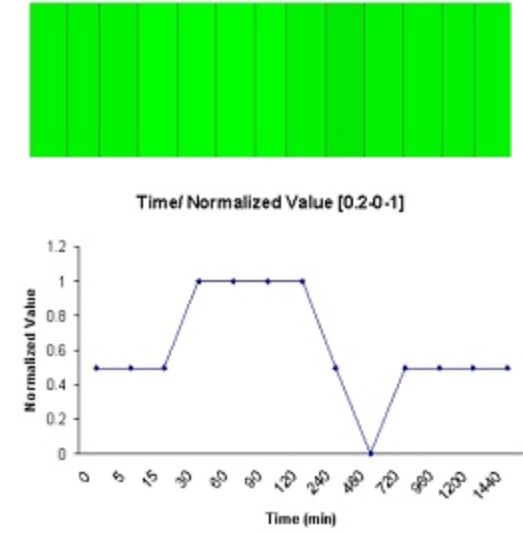

(h)

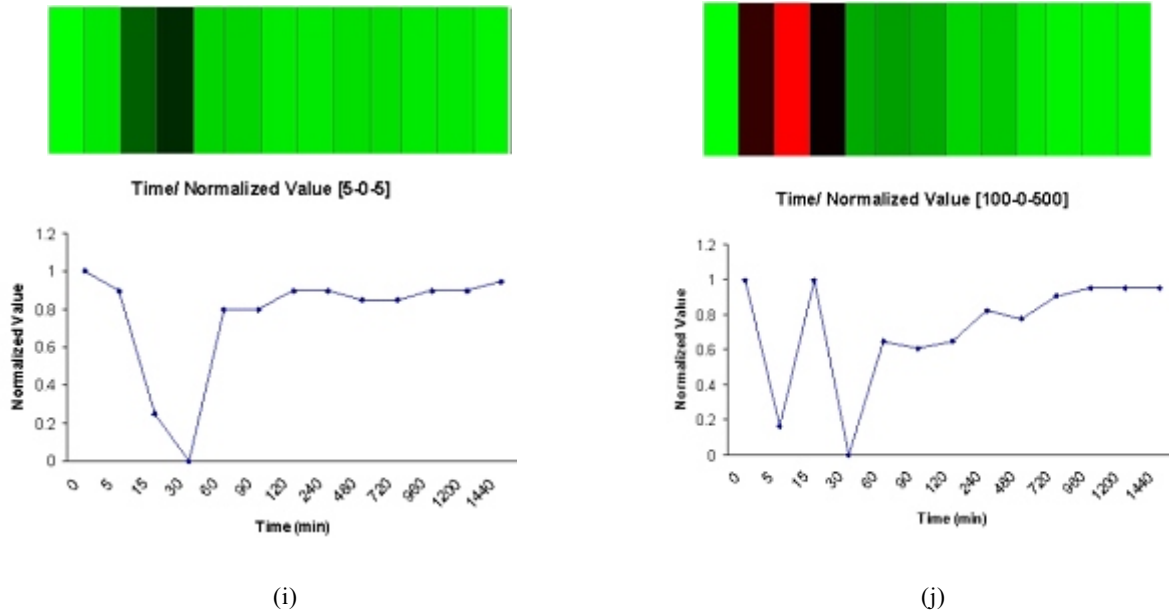

Fig. 5: Heat map and corresponding graph of time-dependent signals in cells treated with 10 cytokine combinations of MK2. For each treatment, the average signal intensities were normalized to the maximal value obtained for that signal and are plotted for the 13 time points

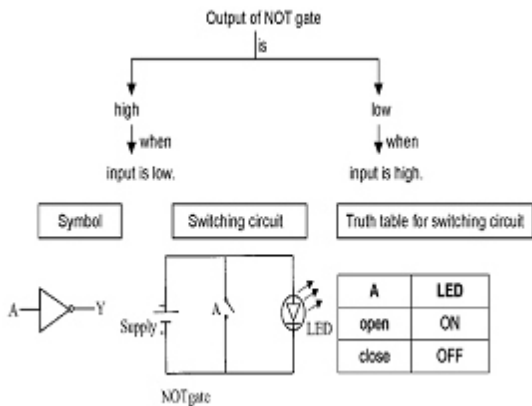

Fig.. 6: Switching Circuit and Truth table for NOT gate

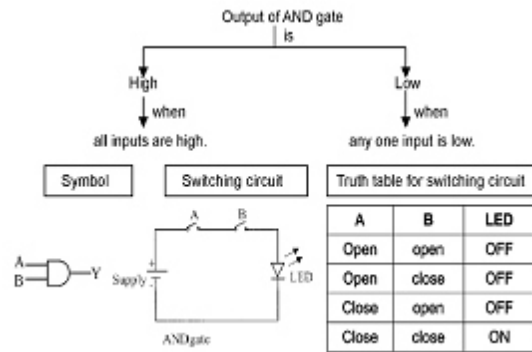

Fig. 7: Switching Circuit and Truth table for AND gate

Following are the various proteins which helps in cell survival/death using MAPK.

- (1) EFG - Insulin / RAS / MEK = ERK
(= 1 Cell Survival, = 0 Cell Death); (Fig. 8)
- (2) EFG - Insulin / MEKK = JNK
(= 1 Cell Survival, = 0 Cell Death); (Fig. 9)
- (3) EFG - Insulin / p38 → MK2
(= 1 Cell Survival, = 0 Cell Death); (Fig. 10)

CONCLUSION

We have demonstrated that the logic gates and bio-circuits that can be applied to predict the cell survival/death with a high level of accuracy. The signaling pathway has reproduced experimental data with accurate. Heat map and corresponding graph were plotted for 10 cytokine combinations. Understanding the nature of signaling networks that control the cell survival/ death is very significant and theoretical calculations seen to be a proper tool for gaining such understanding. The results obtain will give information on how the input signals inducing cell survival/death should be modulated to achieve desire outputs and thus helps the experimentalists to design proposals regarding possible improvements to cell survival/ cell death.

Truth Table			
RAF	MEK	ERK	Output
0	0	0	0
0	0	1	0
0	1	0	0
0	1	1	0
1	0	0	0
1	0	1	0
1	1	0	0
1	1	1	1

Boolean Circuit using Gates

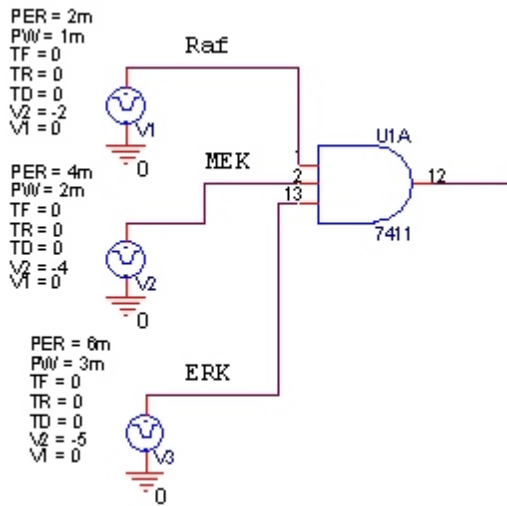

Output of Boolean Circuit

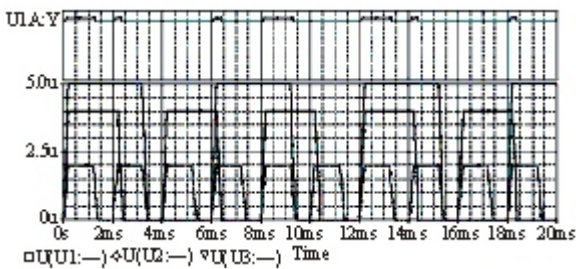

Bio Circuit



Fig. 8: Shows the truth table, logical circuit, output of logic circuit and bio circuit for cell death/ survival for RAF/MEK/ ERK pathway

Truth Table			
RAL	MEK	KJNK	Output
0	0	0	0
0	0	1	0
0	1	0	0
0	1	1	0
1	0	0	0
1	0	1	0
1	1	0	0
1	1	1	1

Boolean Circuit using Gates

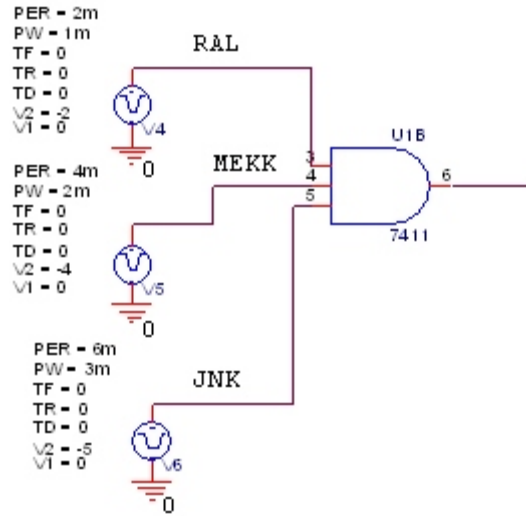

Output of Boolean Circuit

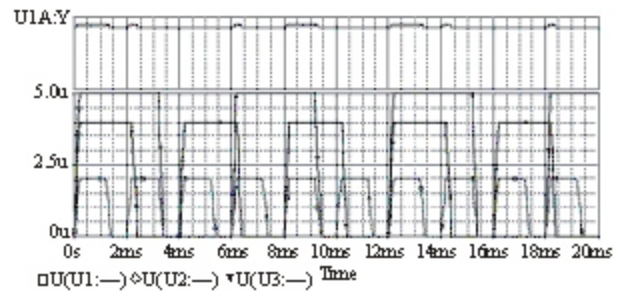

Bio Circuit

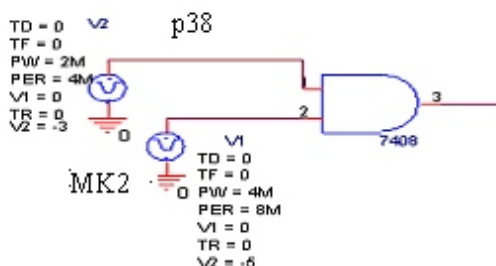

Fig. 9: Shows the truth table, logical circuit, output of logic circuit and bio circuit for cell death/ survival for RAL/ MEKK/ JNK pathway

Truth Table

p38	MK2	Output
0	0	0
0	1	0
1	0	0
1	1	1

Boolean Circuit using Gates



Output of Boolean Circuit

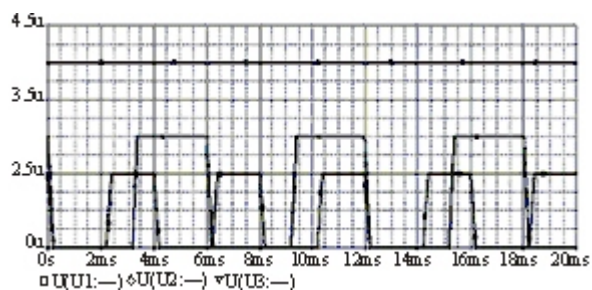
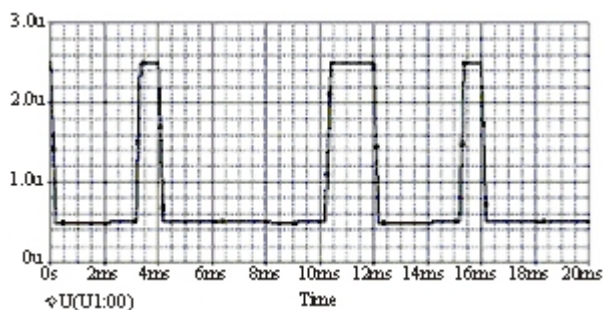

Bio Circuit



Fig. 10: Shows the truth table, logical circuit and bio circuit for cell death/ survival for p38/MK2 pathway

ABBREVIATIONS

- AP-1: Activation Protein 1
- ASK1: Apoptosis signal-regulating kinase 1
- EGF: epidermal growth factor;
- EGFR: epidermal growth factor receptor;
- ERK: extracellular-regulated kinase
- FKHR: Forkhead transcription factor;
- Grb2: growth factor receptor-bound 2
- GSK 3: Glycogen synthase kinase 3
- IR: insulin receptor
- IRS1: insulin receptor substrate 1
- JNK1: c-jun NH₂ terminal kinase 1
- MAP: kinases, mitogen-activated protein kinases
- MEK: mitogen-activated protein kinase and extracellular-regulated kinase kinase
- MK2: mitogen-activated protein kinase-activated protein kinase 2
- mTOR: mammalian target of rapamycin
- NF-κB: nuclear factor-κB
- PDK: Phi Delta Kappa
- PI3K: phosphatidylinositol 3-kinase
- p38: P38 mitogen-activated protein kinases
- Rac: Ras-related C3 botulinum toxin substrate
- SAPK/JNK: Stress-activated protein kinase/Jun-amino-terminal kinase
- SH2: Src homology 2
- SODD: Silencer of death domains
- SOS: Son of Sevenless
- TNF: tumor necrosis factor
- TNFR1: tumor necrosis factor receptor 1
- TNFR2: tumor necrosis factor receptor 2
- TRADD: TNFR associated via death domain
- TRAF2: TNF receptor associated factor 2.

REFERENCES

- Boulton, T.G., S.H. Nye, D.J. Robbins, N.Y. Ip, E. Radziejewska, S.D. Morgenbesser, R. A. DePinho, N. Panayotatos, M.H. Cobb and G.D. Yancopoulos, 1991. ERKs: A family of protein-serine/threonine kinases that are activated and tyrosine phosphorylated in response to insulin and NGF. Cell, 65: 663-675.
- Cross, T.G., D. Scheel-Toellner, N.V. Henriquez, E. Deacon, M. Salmon and J.M. Lord, 2000. Serine/threonine protein kinases and apoptosis. Exp. Cell Res., 256: 34-41.
- Dudley, D.T., L. Pang, S.J., Decker, A.J. Bridges and A.R. Saltiel, 1995. A synthetic inhibitor of the mitogen-activated protein kinase cascade. Proc. Natl. Acad. Sci. USA. 92(17): 7686-7689.
- Erhardt, P., E.J. Schremser and G.M. Cooper, 1999. B-Raf inhibits programmed cell death downstream of cytochrome c release from mitochondria by activating the MEK/Erk pathway. Mol. Cell. Biol., 19: 5308-5315.

- Eyers, P.A., M. Craxton, N. Morrice, P. Cohen and M. Goedert, 1998 Conversion of SB 203580-insensitive MAP kinase family members to drug-sensitive forms by a single amino-acid substitution. *Chem. Biol.*, 5(6): 321-328.
- Gaudet, S., K.A. Janes, J.G. Albeck, E.A. Pace, D.A. Lauffenburger and P.K. Sorger, 2005. A compendium of signals and responses triggered by prodeath and prosurvival cytokines. *Mol. Cell. Proteomics*, 4(10):1569-1590.
- Greulich, H. and R.L. Erikson, 1998. An analysis of Mek1 signaling in cell proliferation and transformation. *J. Biol. Chem.*, 273: 13280-13288.
- Hallberg, B., S.I. Rayter and J. Downward, 1994. Interaction of Ras and Raf in intact mammalian cells upon extracellular stimulation. *J. Biol. Chem.*, 269(6): 3913-3916.
- Janes, K.A., J.G. Albeck, S. Gaudet, P.K. Sorger, D.A. Lauffenburger and M.B. Yaffe, 2005. A systems model of signaling identifies a molecular basis set for cytokine-induced apoptosis. *Science*, 310: 1646-1653.
- Kyriakis, J.M. and J. Avruch, 1996. Sounding the alarm: protein kinase cascades activated by stress and inflammation. *J. Biol. Chem.*, 271: 24313-24316.
- Pearson, G., F. Robinson, G.T. Beers, B.E. Xu, M. Karandikar, K. Berman and M.H. Cobb, 2001. Mitogen-activated protein (MAP) kinase pathways: regulation and physiological functions. *Endocrine Rev.*, 22(2):153-83.
- Schlessinger, J., 2000. Cell signaling by receptor tyrosine kinases. *Cell*, 103: 211-25.
- Weiss, R. and S. Basu, 2002. Device physics of cellular logic gates, First Workshop on Non-Silicon Computing, Boston, MA.
- Weiss, R., S. Basu, S. Hooshangi, A. Kalmbach, D. Karig, R. Mehreja and I. Netravali, 2003. Genetic circuit building blocks for cellular computation, communications, and signal processing. *Natural Comput.*, 2(1): 47- 84.
- Zhou, G., Bao, Z. Q., Dixon, J. E., 1995. Components of a new human protein kinase signal transduction pathway. *J. Biol. Chem.* 270 (21), 12665-12669.