

ENVIRONMENTAL DATA IN ARDUINO IoT CLOUD

Project report submitted in partial fulfilment of the requirement for the degree

of

Bachelor of Technology

in

Information Technology

By

Arushi (181461)

Harshita Sharma (181484)

Under the supervision of

Dr. Rajinder Sandhu

to



Department of Computer Science & Engineering and Information Technology

Jaypee University of Information Technology Wagnaghat, Solan-173234,

Himachal Pradesh

CERTIFICATE

This is to certify that the work which is being presented in the project report titled “**Environmental Data in Arduino Iot Cloud**” in partial fulfilment of the requirements for the award of the degree of B.Tech in Information Technology and submitted to the Department of Computer Science Engineering and Information Technology, Jaypee University of Information Technology, Waknaghat, is an authentic record of work carried out by **Arushi (181461) and Harshita Sharma (181484)** during the period from January 2022 to May 2022 under the supervision of **Dr. Rajinder Sandhu**, Department of Computer Science Engineering and Information Technology, Jaypee University of Information Technology, Waknaghat.

Arushi (181461)

Harshita Sharma (181484)

The above statement made is correct to the best of my knowledge.

Dr. Rajinder Sandhu Assistant Professor (SG)

Computer Science Engineering and Information Technology, Jaypee University of Information Technology, Waknaghat.

DECLARATION

I hereby declare that, this project has been done by me under the supervision of Dr. Rajinder Sandhu, Assistant Professor(SG), Jaypee University of InformationTechnology. I also declare that neither this project nor any part of this project hasbeen submitted elsewhere for award of any degree or diploma.

Supervised by:

Dr. Rajinder Sandhu Assistant Professor (SG)

Department of Computer Science Engineering and Information Technology,
Jaypee University of Information Technology, Waknaghat.

Submitted by:

Arushi (181461)

Harshita Sharma (181484)

Information Technology

Jaypee University of Information Technology, Waknaghat.

ACKNOWLEDGMENT

Firstly, I express my heartiest thanks and gratefulness to almighty God. His divine blessings made it possible to complete the project work successfully.

I am really grateful and wish to profound my indebtedness to Dr. Rajinder Sandhu, Asst. Professor(SG), Department of CSE & IT, Jaypee University of Information Technology, Waknaghat. Deep Knowledge and keen interest of my supervisor in the field of cloud and arduino to carry out this project. His endless patience, scholarly guidance, continual encouragement, constant and energetic supervision, constructive criticism, valuable advice, reading many inferior drafts and correcting them at all stage have made it possible to complete this project.

I would like to express my heartiest gratitude to Dr. Rajinder Sandhu, Department of CSE & IT, for his kind help to finish my project.

I would also generously thank each one of those individuals who have helped me straight forwardly or in a roundabout way in making this project a win. In this unique situation, I might want to thank the various staff individuals, both educating and non-instructing, which have developed their convenient help and facilitated my undertaking.

Finally, I must acknowledge with due respect the constant support and patients of my parents.

Arushi (181461)

Harshita Sharma (181484)

TABLE OF CONTENT

Title Page	i
Certificate.....	ii
Declaration.....	iii
Acknowledgement	iv
Table of Content	vi
List of Figures.....	ix
Abstract.....	xi

Chapter-1 INTRODUCTION

1.1 Introduction	2
1.2 Problem Statement.....	4
1.3 Objectives.....	6
1.4 Methodology.....	9
1.5 Organization.....	11

Chapter-2 LITERATURE SURVEY

2.1 Research Paper 1	14
2.2 Research Paper 2... ..	17
2.3 Research Paper 3... ..	20
2.4 Research Paper 4... ..	23

Chapter-3 SYSTEM DEVELOPMENT

3.1 Design.....	26
3.2 Block Diagram.....	28
3.3 Algorithm.....	31

28Model Development.....	35
Chapter-4 PERFORMANCE ANALYSIS	
4.1 Experimental Analysis.....	40
4.2 Results.....	44
Chapter-5 CONCLUSIONS	
5.1 Conclusions.....	45
5.2 Future Scope.....	47
5.3 Applications.....	50
REFERENCES.....	51
APPENDICES.....	53

LIST OF FIGURES

Figure 1.01	Sample output of the project done in last semester.....	02
Figure 1.02	Depicting the various connections.....	03
Figure 1.03	Testing the water sample.....	03
Figure 1.04	Sample output of our project.....	05
Figure 1.05	Configuring and creating variables.....	08
Figure 1.06	Adding ESP32 and TDS Sensor.....	08
Figure 1.07	Setting the app.....	09
Figure 1.08	water purity checking of an Aquarium.....	09
Figure 1.09	showing the connections for interfacing of sensors.....	10
Figure 1.10	Organization of the setup.....	11
Figure 2.01	System design.....	12
Figure 2.02	Temp in atmosphere wrt time.....	13
Figure 2.03	Humidity in atmosphere wrt time.....	13
Figure 2.04	CO content.....	14
Figure 2.05	Dust density.....	14
Figure 2.06	Humidity wrt time.....	14
Figure 2.07	Web portal controlling the bulb.....	15
Figure 2.08	System design of home automation.....	16
Figure 2.09	Output of the wifi smart thermostat.....	17
Figure 2.10	System design of reseatch paper.....	18
Figure 2.11	Depicts the temp.....	19
Figure 2.12	System design of reseatch paper.....	20
Figure 2.13	Deoicts the testing of soil.....	21
Figure 3.01	Analysis of the project.....	22
Figure 3.02	DS18B20 temp sensor.....	23
Figure 3.03	TDS sensor.....	24
Figure 3.04	System design of the project.....	25
Figure 3.05	Measurement of water quality.....	25
Figure 3.06	Design of water purity report.....	25
Figure 3.07	DS18B20 temp sensor.....	26
Figure 3.08	ESP32.....	26
Figure 3.09	TDS sensor.....	27

Figure 3.10	4.7k resistor.....	27
Figure 3.11	Jumper wires.....	27
Figure 3.12	Breadboard.....	27
Figure 3.13	Connections.....	29
Figure 3.14	Showing the connections.....	30
Figure 3.15	Block diagram.....	31
Figure 4.01	Setup of arduino iot cloud.....	35
Figure 4.02	Creating things.....	35
Figure 4.03	Adding variables.....	36
Figure 4.04	Adding first variable as led.....	36
Figure 4.05	Adding second variable as temp.....	37
Figure 4.06	Adding third variable as humidity.....	37
Figure 4.07	Adding and linking the device.....	38
Figure 4.08	Adding and linking the wifi network.....	38
Figure 4.09	Dashboard.....	38
Figure 4.10	Widgets.....	39
Figure 4.11	Compilation of code.....	39
Figure 4.12	Code uploading to ESP32.....	40
Figure 4.13	Desktop output.....	41
Figure 4.14	Cell phone results.....	41
Figure 4.15	Setup model results.....	42
Figure 4.16	Water purity regulating system.....	42
Figure 4.17	Connections made for the project.....	43
Figure 4.18	Output results.....	43
Figure 5.01	Shows output of project.....	45
Figure 5.02	Depiction of the environmental data.....	47
Figure 5.03	Depicts the home automation system.....	48

ABSTRACT

Arduino IoT Cloud is an application/ Software which enables us to construct the connected systems or objects in a quick short, easy and securely manner. We can monitor the work from anywhere and everywhere with the help of a simple user interface. Also it helps us to connect Multiple devices with each other that helps us to makes them exchange data in real time which is very advantageous in the coming technologies.

Arduino IoT Cloud is a product of itself, where we would be able to provide or initiate the code template in the Arduino Iot cloud within it , followed by the editing and the uploading of the code to the board using the Arduino Web Editor. Also In Recent times Arduino cloud also added support system for various hardware objects like ESP32 boards , sensors for easy development of the setup and to make the Iot Cloud work efficiently. We ourselves have made use of the following system where we used the ESP32 board and DHT11 sensor for the Environmental Monitoring as explained in the report.

We have been working on Arduino iot cloud application since last semester where we completed and learned how to read and monitor the temperature and humidity from DHT11 Magicbit module and visualize data on the widgets available in the Arduino Cloud as well as represent it on our cell phones for easy monitoring. It is basically the design of the process on the ESP32 interfaced with DHT 11 sensor made through Arduino Iot Cloud for monitoring/measuring temperature and humidity in real-time. It can bs used for various applications but our project basically counter the monitoring of the temperature and humidity of the soil.

This work is done as an hardware project and will be continuing it as Major Project part 2 where we will be learning and adding an application in Arduino Iot cloud application .

Thus the main aim of our project to add an application of Monitoring Water Quality with TDS Sensor, Temperature Sensor, ESP32 WIFI Module & Arduino Iot Display. We will display the real-time value of Water TDS and Temperature on Arduino Iot Cloud Application which will be live monitoring and record of past values is also saved.

Water quality management is an important part of our daily lives now a days . With the increasing population and increasing pollution all the natural resources are being damaged and are being polluted . The main example of this is water bodies. Water is a natural resource

and one of the main component which is required to be alive and live a healthy life , thus it is the main concern for todays and future generations to stop polluting water bodies instead start saving and help all living beings lead a healthy life. This is only possible if the consumption of water of all living beings be it humans ,animals plants is monitored . therefore we tried at our level to build an object which will monitor the water with the help of TDS sensor and ESP32 and display the real time values in Arduino IoT Lcd screen or on cell phones.

CHAPTER 1: INTRODUCTION

1.1 Introduction

With the changing time and upcoming new latest technologies the 21st century has been noticing a huge and big shift focusing on global interests onto IoT with more than one opportunities and diverse possibilities for growth development. The devices/ objects that let them upload the input as well as output to the Internet using cloud provisioning. Major studies region in which many techniques are being placed with the aid of using researchers so one can manage and manipulate temperature and humidity. There is want to increase a low-fee and strength ingesting server to screen actual time situations of temperature and humidity in diverse settings.

Arduino IoT Cloud is an application/ Software which enables us to construct the connected systems or objects in a quick short, easy and securely manner. We can monitor the work from anywhere and everywhere with the help of a simple user interface. Also it helps us to connect Multiple devices with each other that helps us to makes them exchange data in real time which is very advantageous in the coming technologies.

Arduino IoT Cloud is a product of itself, where we would be able to provide or initiate the code template in the Arduino Iot cloud within it , followed by the editing and the uploading of the code to the board using the Arduino Web Editor. Also In Recent times Arduino cloud also added support system for various hardware objects like ESP32 boards , sensors for easy development of the setup and to make the Iot Cloud work efficiently. We ourselves have made use of the following system where we used the ESP32 board and DHT11 sensor for the Environmental Monitoring as explained in the report.

We have been working on Arduino iot cloud application since last semester where we completed and learned how to read and monitor the temperature and humidity from DHT11 Magicbit module and visualize data on the widgets available in the Arduino Cloud as well as represent it on our cell phones for easy monitoring. It is basically the design of the process on the ESP32 interfaced with DHT 11 sensor made through Arduino Iot Cloud for monitoring/measuring temperature and humidity in real-time. It can bs used for various applications but our project basically counter the monitoring of the temperature and humidity of the soil.

The sensed values will be sent by DTH11 to the Arduino IoT Cloud where these values will be displayed on the desktop screen and will also be monitored using dashboard in our cell phone. We will be using ESP32 microcontroller chip as a link communicator between the Arduino Cloud IoT and the sensor. Firstly we will test this out by sending a random value from the board to the cloud, and by creating turn on/off an led on the board through the cloud.



Figure 1.1: Sample output of the project done last semester

This work is done as an hardware project and will be continuing it as Major Project part 2 where we will be learning and adding an application in Arduino Iot cloud application.

Thus the main aim of our project to add an application of Monitoring Water Quality with TDS Sensor, Temperature Sensor, ESP32 WIFI Module & Arduino Iot Display. We will display the real-time value of Water TDS and Temperature on Arduino Iot Cloud Application which will be live monitoring and record of past values is also saved. Followed by sending of those sensed values through TDS sensor to the Arduino IoT Cloud wherein those values may be displayed at the computing device display and also will be monitored by the use of dashboard in our mobile phones.

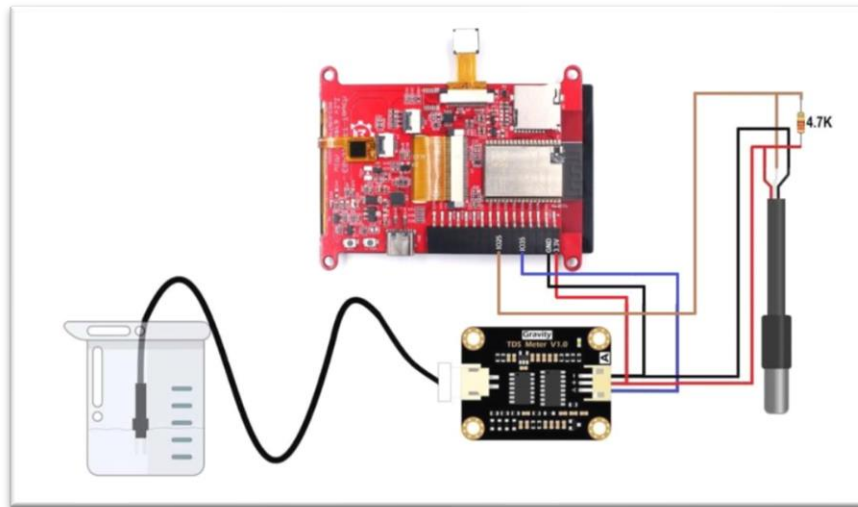

Figure 1.2 : Depicting the various connections while setting up the project.

Water quality management is an important part of our daily lives now a days . With the increasing population and increasing pollution all the natural resources are being damaged and are being polluted . The main example of this is water bodies. Water is a natural resource and one of the main component which is required to be alive and live a healthy life , thus it is the main concern for todays and future generations to stop polluting water bodies instead start saving and help all living beings lead a healthy life.

This is only possible if the consumption of water of all living beings be it humans ,animals plants is monitored . therefore we tried at our level to build an object which will monitor the water with the help of TDS sensor and ESP32 and display the real time values in Arduino IoT Lcd screen or on cell phones.

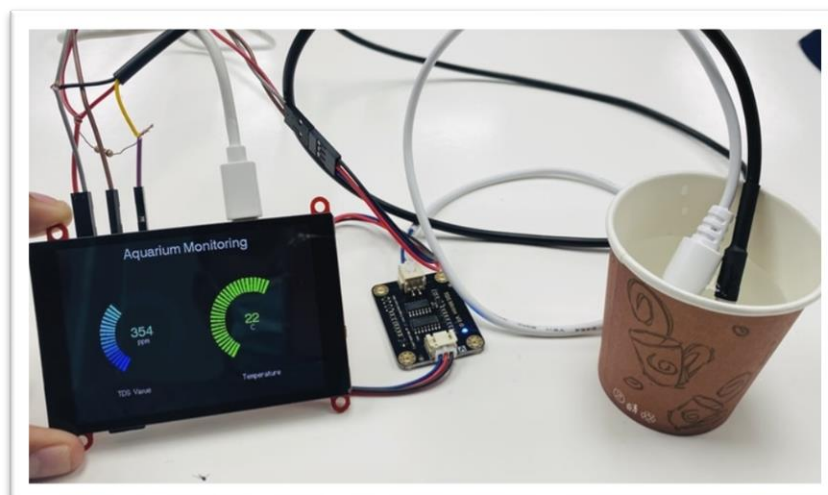

Figure 1.3 : testing the water sample

1.2 Problem Statement

The design of the project is the layout which is the procedure that is primarily based on ESP32 interfaced with TDS Sensor, Temperature Sensor, ESP32 WIFI Module & Arduino Iot Display made for monitoring/measuring the water quality management system in real-time for the environmental data such as for the water quality management system , human water consumption , marine lifecycle , plants requirements etc.

Followed by sending of those sensed values through TDS sensor to the Arduino IoT Cloud wherein those values may be displayed at the computing device display and also will be monitored by the use of dashboard in our mobile phones.

We will use ESP32 microcontroller to communicate /work with the Arduino Cloud IoT. Firstly we can check this out through sending a random value from the board to the cloud, and through developing the on/off an led at the board with the help of the cloud .

Arduino Iot Cloud Application a product of itself, where we would be able to provide or initiate the code template in the Arduino Iot cloud within it , followed by the editing and the uploading of the code to the board using the Arduino Web Editor. Also In Recent times Arduino cloud also added support system for various hardware objects like ESP32 boards , sensors for easy development of the setup and to make the Iot Cloud work efficiently.

ESP32 Board is basically a microcontroller chip which is used for the working of the Iot Cloud efficiently with the powerful Wi-Fi+Bluetooth/Bluetooth LE targeting the various Iot Applications and projects.

Monitoring and managing the quality of water is very important for maintaining the ecosystems well-being balanced lifecycle in order to maintain a proper sustainable development.

Knowing the condition of our natural resource water by monitoring is important to determine the condition of water bodies the amount of pollutants, chemicals from industries source of polluting the water bodies for further efforts to be given to protect our natural resources It also helps the people to protect from various water borne diseases that leads to humans through bad water and tells us is it suitable for drinking or not.

Not only humans even the Aquatic life is very much affected with the bad quality of water . With monitoring of purity of water even the aquatic livelihood is benefited.

The working of the project takes place with the help of electrical conductivity . Electrical Conductivity of water is basically being carried out in the project in order to detect the purity of water through the TDS value. The ability to conduct an electric current in the testing of

water quality where the Salts or other chemicals that are dissolved in water can be measured with the help of the concept of the breaking down of the charged ions into positively and negatively charged ions. The movable ions in the water helps us to conduct electricity where the water's electrical conductivity depends on the concentration of ions. Total dissolved solids (TDS) and the salts present are used to calculate the E Conductivity of water. Which helps us to check the purity of water The purer the water, the lower the conductivity. Example distilled water is an insulator, but salt water is a very efficient electrical conductor.



Figure 1.4 : sample output of our project

Monitoring and managing the quality of water is very important for maintaining the ecosystems well-being balanced lifecycle in order to maintain a proper sustainable development.

Knowing the condition of our natural resource water by monitoring is important to determine the condition of water bodies the amount of pollutants, chemicals from industries source of polluting the water bodies for further efforts to be given to protect our natural resources It also helps the people to protect from various water borne diseases that leads to humans through bad water and tells us is it suitable for drinking or not. . The movable ions in the water helps us to conduct electricity where the water's electrical conductivity depends on the concentration of ions. Total dissolved solids (TDS) and the salts present are used to calculate the E Conductivity of water. Which helps us to check the purity of water The purer the water, the lower the conductivity. Example distilled water is an insulator, but salt water is a very efficient electrical conductor

1.3 Objectives

With the changing time and upcoming new latest technologies the 21th century has been noticing a huge and big shift focusing on global interests onto IoT with more than one opportunities and diverse possibilities for growth development.

The devices/ objects that let them upload the input as well as output to the Internet using cloud provisioning.

Major study region in which many techniques that are being noticed by the researchers inorder to manage and manipulate the figures or data which has been recorded by the Arduino iot cloud with the help of sensors .

There is want to increase a low-fee and cheap and regular strength ingesting server made to screen actual and real time situations of our environment and natural resources like temperature and humidity as done in major project part 1 and water quality check as it is the need of the hour. Air records can be acquired and monitor as a concern of the environmental issues like (air pollution check) which will give us the continuous and regular monitoring of the figures.

Soil is also an environmental issue where growing crops in worst climatic conditions is being the recent challenge in various parts of the world thus as for checking the fertility of soil like the temperature as well as the humidity for the productiveness of the crops in various conditions.

Water quality management is an important part of our daily lives now a days . With the increasing population and increasing pollution all the natural resources are being damaged and are being polluted.

Water is a natural resource and one of the main component which is required to be alive and live a healthy life , thus it is the main concern for todays and future generations to stop polluting water bodies instead start saving and help all living beings lead a healthy life.

This is only possible if the consumption of water of all living beings be it humans ,animals plants is monitored . therefore we tried at our level to build an object which will monitor the water with the help of TDS sensor and ESP32 and display the real time values in Arduino IoT Lcd screen or on cell phones.

1.4 Methodology

- The Arduino IoT Cloud is designed to assist humans with the upcoming new technologies. It basically is designed recently in order to make use of a software instead of hardware's for easiness and affordable price for the coming time. It creates things with easiness.
- The main step is as easy as connecting a device to a Bluetooth, where creating and developing the variables and a dashboard to visualize it can make your half steps done.
- As we create a Thing, as in the application of Arduino IoT cloud a sketch is generated automatically as a part of the software programming, and updates with all modifications we make within the cloud.
- By making this task we are able to discover ways to study water quality management system so that the main concern for today's and future generations to stop polluting water bodies instead start saving and help all living beings lead a healthy and sustained life. This is only possible if the consumption of water of all living beings be it humans, animals and plants is monitored in various conditions with this Arduino IoT Cloud Application is used to monitor and keep it as a record.
- Monitoring the records at the desktop to be had within the Arduino IoT Cloud And ESP32 microcontroller to communicate/ speak with the Arduino Cloud IoT using on/off LED lights.
- Water is a natural resource and one of the main components which is required to be alive and live a healthy life, thus it is the main concern for today's and future generations to stop polluting water bodies instead start saving and help all living beings lead a healthy life.
- This is only possible if the consumption of water of all living beings be it humans, animals and plants is monitored. Therefore we tried at our level to build an object which will monitor the water with the help of TDS sensor and ESP32 and display the real-time values in Arduino IoT LCD screen or on cell phones.
- Below mentioned are the steps of the working of the project from setting up the Arduino IoT cloud application to the setting up the sensors for our hardware project of water quality monitoring and temperature and humidity sensing.

1.4.1 Steps of Working Of our Project

Step 1: Configuring Arduino Iot Cloud Dashboard and creating variables like Water Quality ,Temperature and Led1.

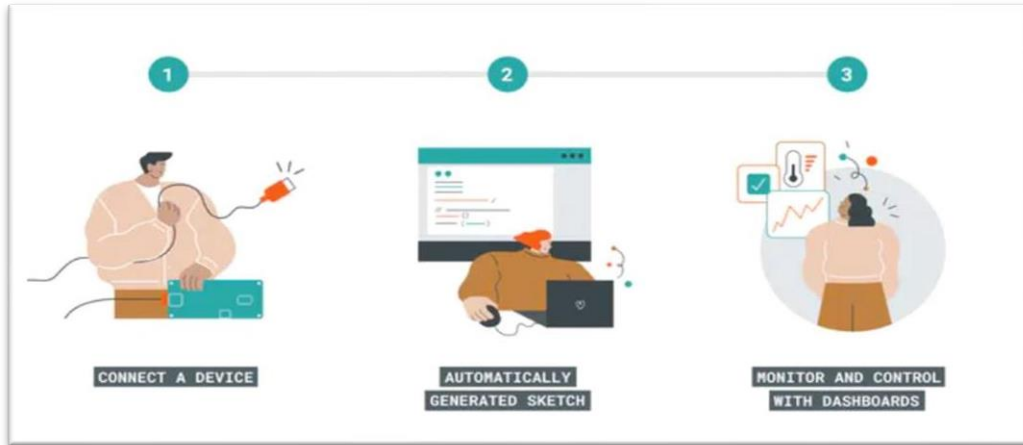

Figure 1.5: Configuring and creating variables

Step 2: Backend installation are being carried out and further creating the agent to the Arduino Iot Cloud application as well as Testing the setup on Web Dashboard by checking this out through sending a random value from the board to the cloud, and through developing the on/off an led at the board with the help of the cloud .

Step 3: Adding ESP32 ,TDS Sensor, Temperature Sensor, ESP32 WIFI Module & Arduino Iot Display device in Arduino Iot Cloud with installation of WIFI and Bluetooth Widgets to the cloud with the help of ESP32 chip board.

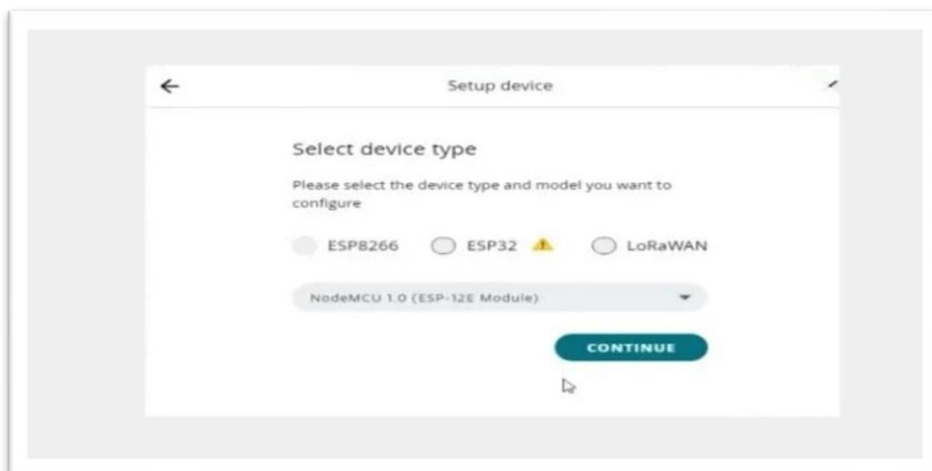

Figure 1.6: Adding ESP32 and TDS Sensor in Arduino Iot cloud

Step 4: The final and the main step is the Setting of the Arduino Iot cloud remote app on cell phone and checking the setup Monitoring the temperature and humidity and working of the led bulbs.

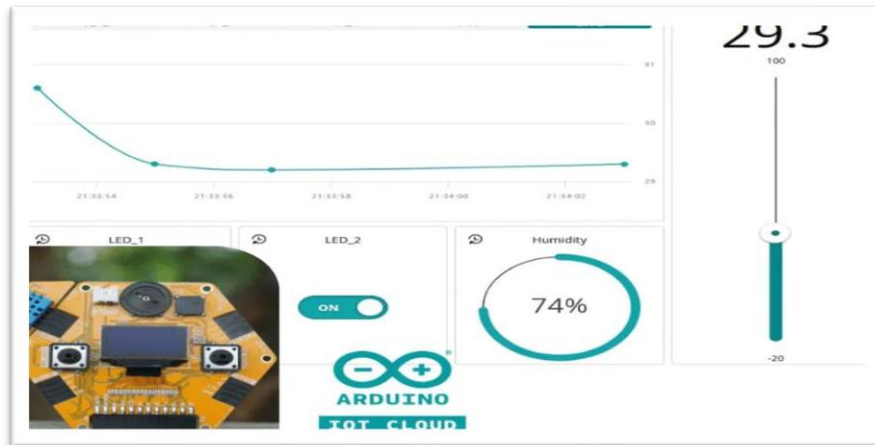

Figure 1.7: Setting the app

Step 5: The final results where the Temperature , Humidity and water quality system is being created and monitored as shown in the figure where the water purity check is being made in an aquarium.

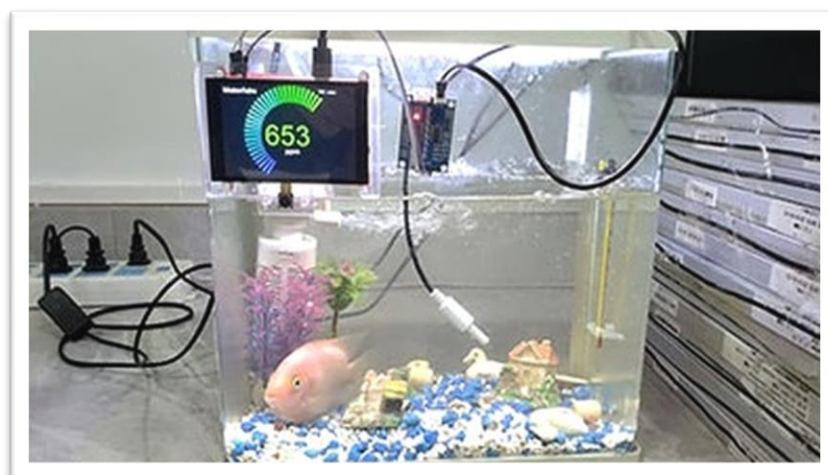

Figure 1.8: water purity checking of an Aquarium

1.5 Organization

- Arduino Iot Cloud Application a product of itself, where we would be able to provide or initiate the code template in the Arduino Iot cloud within it , followed by the editing and the uploading of the code to the board using the Arduino Web Editor.
- Also In Recent times Arduino cloud also added support system for various hardware objects like ESP32 boards , sensors for easy development of the setup and to make the Iot Cloud work efficiently.
- ESP32 Board is basically a microcontroller chip board which is used for the working of the Iot Cloud efficiently with the powerful Wi-Fi+Bluetooth/Bluetooth LE targeting the various Iot Applications and projects.
- DS18B20 Temperature Sensor: digital waterproof temperature sensor is a digital signal output with a calibrated temperature of water. As concerned with the project the main aim is to monitor the water quality management system as temperature plays a major role in quality check.

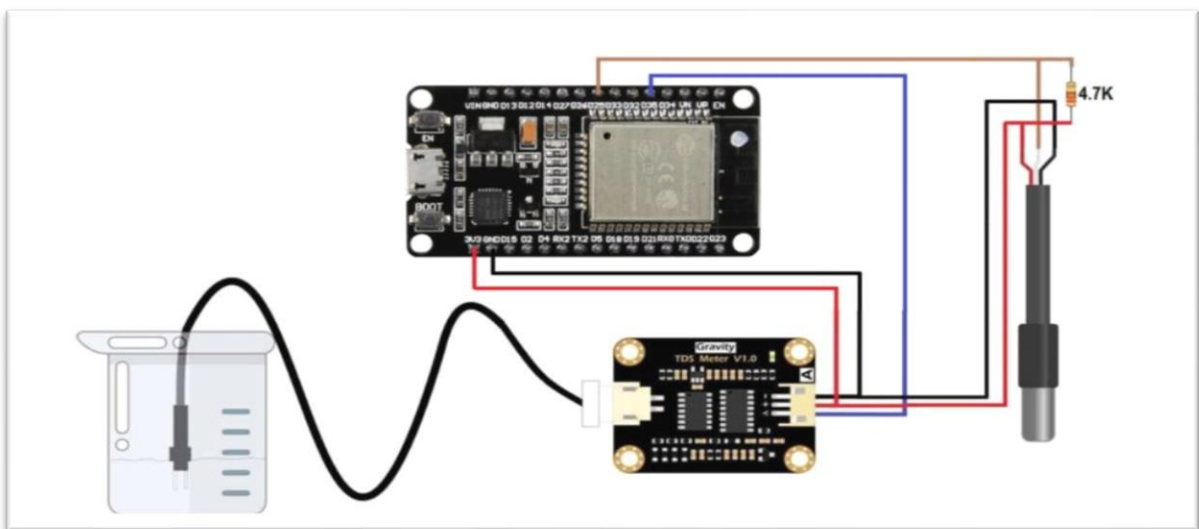

Figure 1.9 showing the connections for interfacing of sensors

- The main step is as easy as connecting a device to a Bluetooth , where creating and developing the variables and a dashboard to visualize it can make your half steps done.
As we create a Thing, as in the application of Arduino Iot cloud a sketch is generated automatically as a part of the software programming , and updates with all modifications we make withinside the cloud. .
- By making this task or project we are able to discover ways to study and monitor the quality of water .
- By making this task we are able to discover ways to study water quality management system so that the main concern for todays and future generations to stop polluting water bodies instead start saving and help all living beings lead a healthy and sustained life. This is only possible if the consumption of water of all living beings be it humans, animals and plants is monitored in various conditions with this Arduino Iot Cloud Application is used to monitor and keep it as a record.

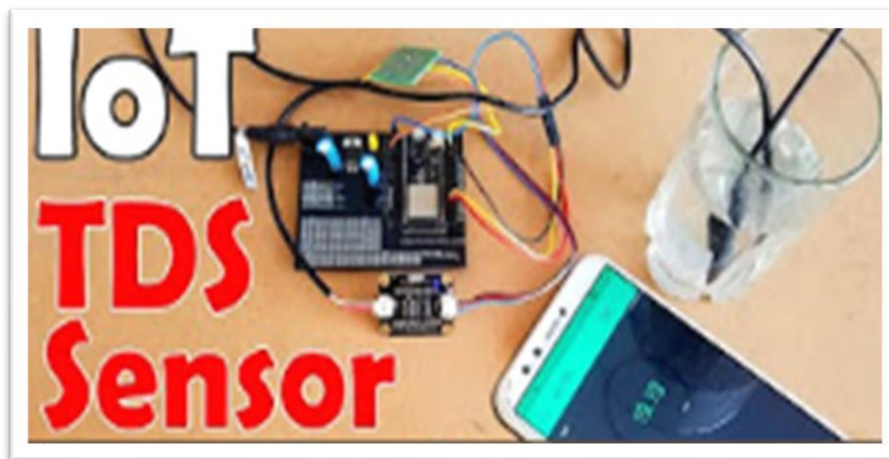

Figure 1.10 Organization of the setup used to build our project

CHAPTER 2: LITERATURE SURVEY

2.1 IoT based Air Quality Index Monitoring using ESP32 (Volume: 08 Issue:04 | Apr 2021)

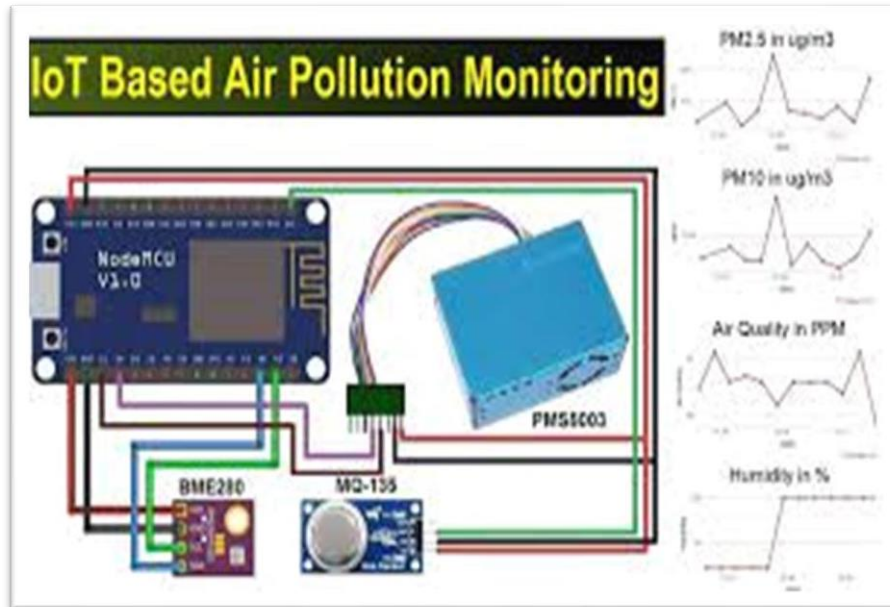

Figure 2.1 : system design of the current research paper

IoT based Air Quality Index Monitoring using ESP32 research paper

- Pollution impacts our health as well as causes major environmental changes like Global warming and weather variations or conditions.
- There is a need to constantly measure, analyze and monitor the air quality on a real-time basis so that appropriate measures can be taken whenever needed.
- For this, the proposed model deals with the concept of the Internet of Things to let the user/or the monitor know about the concentration of harmful gases present around him and thus letting the user know the quality of air. In addition to this giving us figures of the regular recorded temperature as well as humidity for the exact monitoring of the air quality.
- The concept provided by the research paper is as of the Arduino Iot cloud applications combined with the sensors and chips that help us to regularly record the figures for the

regular monitoring and analyzing the exact situation of any particular region in any particular period of time.

Results of the following research paper:



Figure 2.2 : Temperature (°C) in atmosphere w.r.t time



Figure 2.3 : : Humidity (%) in atmosphere w.r.t time



Figure 2.4: CO content (PPM) in atmosphere w.r.t time



Figure 2.5: Dust density (mg/m³) in atmosphere w.r.t time

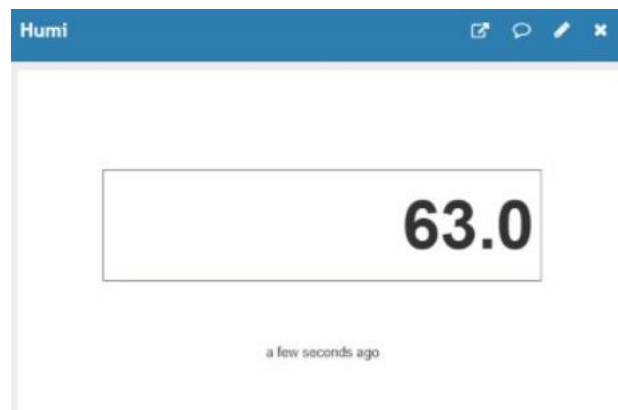

Figure 2.6 : Humidity in Atmosphere w.r.t time

2.2 Home Automation, IoT, ESP32 Module, Relay Module, CloudServer(2019 IEEE)



Figure 2.7: Web portal controlling the bulb with ESP32 board

Home Automation, IoT, ESP32 Module, Relay Module, Cloud Server paper

- We are living in the fourth industrial revolution and with this changing scenario of the world and upcoming new technologies our life is becoming more comfortable and smarter .
- Just with the help of continuous upgradation and with the coming new generations of technology. The paper have been introduced for the clarification of the newly updated technology i.e Arduino Iot Cloud Application which is an easier version of the Arduino hardware used to Make Iot projects . As it's a software application thus provides us with the cheaper as well as most accessible in terms of Iot Projects .
- In this paper, we present an IoT based low-cost smart home automation system.
- This system is based on a web portal with further usage of an ESP32 Wi-Fi module which is the controller of the setup. Also, a private home web server is developed which

is used for maintaining the home appliances like the bulb , led ON/OFF , AC , Television etc .

- They plan for working on with the basic home appliances as a “Proof-of-Concept” for this project which includes Fan, Light, Coffee Machine and Door Alarms. The new addition on this project research paper is the voice command given by the user and is elucidated by the device using the language processing i.e the natural language processing It shows us the way how the determination of natural language processing is done inorder to take the commands of the user to provide the results as an output .
- Just with the help of continuous upgradation and with the coming new generations of technology. The paper have been introduced for the clarification of the newly updated technology i.e Arduino Iot Cloud Application which is an easier version of the Arduino hardware used to Make Iot projects . As it’s a software application thus provides us with the cheaper as well as most accessible in terms of Iot Projects .



Figure 2.8: System design of the Home Automation system

2.3 A Remote Thermostat Control And Temperature Monitoring System Of a single Family House Using OpenHab - Vol 4 No 5(2020)EJECE



Figure 2.9 : Output of the WIFI smart thermostat using ESP32 chip

A Remote Thermostat Control And Temperature Monitoring System Of a single Family House Using OpenHab paper

- With the newly updated Arduino Iot Cloud another application of the remote thermostat was introduced by the EJECE where they introduced the cloud application to the platform named openHAB which is basically a clever domestic automation is used as a domestic server which is used here for the remote smart thermostat .
- The essential goals of this project are the layout at a low-price tracking and manipulate the device for thermal strength structures to screen as well as monitor the real-time temperature data and records, further the design the control device for thermostat settings with the subsequent functions including manual/computerized operations, local/faraway manipulate options

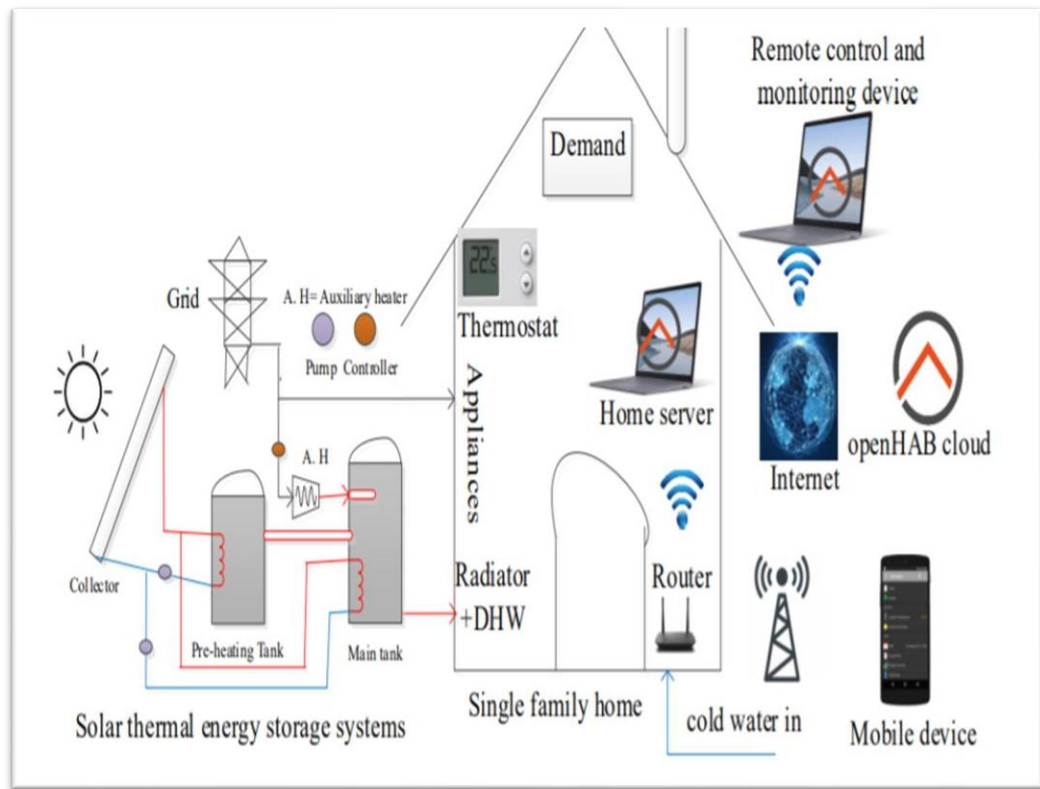

Figure 2.10: System Design of the research paper

- The system is designed as per the basic requirements in our middle class requirements so that each and every part of the society can embrace the opportunity of the project when in market. The advantages of making such projects are as follows
 - a. user-friendly
 - b. low power consumption
 - c. low cost
 - d. allowing users to use a traditional thermostat
 - e. to monitor the room
 - f. ambient temperature
 - g. and to control the thermostat settings locally and remotely.

- All the measurements and the records analysis can be done and can be visualized by the user through the desktop to the devices that are connected like cell phones for easy management .
- In the most residential house in Canada and other abroad countries the usage of large amount of electricity for space heating and water heating. Are noticed at a higher rate thus To do that it finds out to be very costly and Due to the mismanagement of the electrical heater and the compliance that uses electricity would increase the mis management skills financially . To ensure the appropriate management of heating elements, and to visualize the of room temperature and humidity level remotely on our cell phones the concept of home automation is introduced to reduce the system cost and power consumption.
- Thus the following research paper or journal depicts the remote control thermostat thatis being organized by the ESP32 Arduino Iot cloud as well as the Open Hab system for the successful completion of the project.

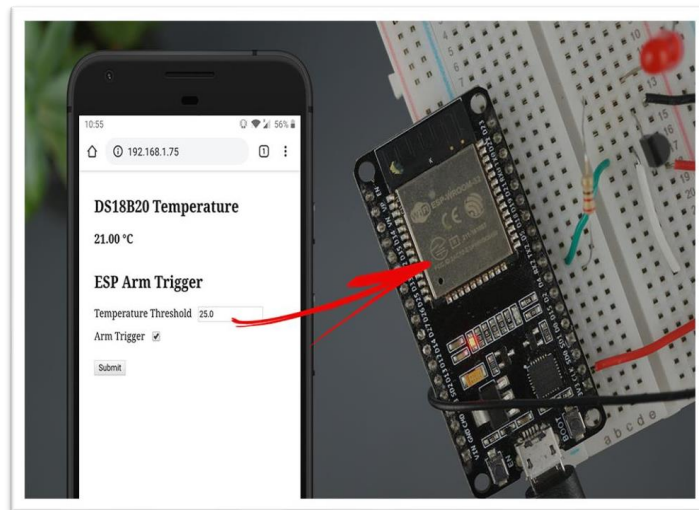

Figure 2.11 : Depicts the temperature shown by the thermostat using ESP32

2.4 Solar Water Pumping System Control Using A Low Cost ESP32 Microcontroller (IEEE 2018)

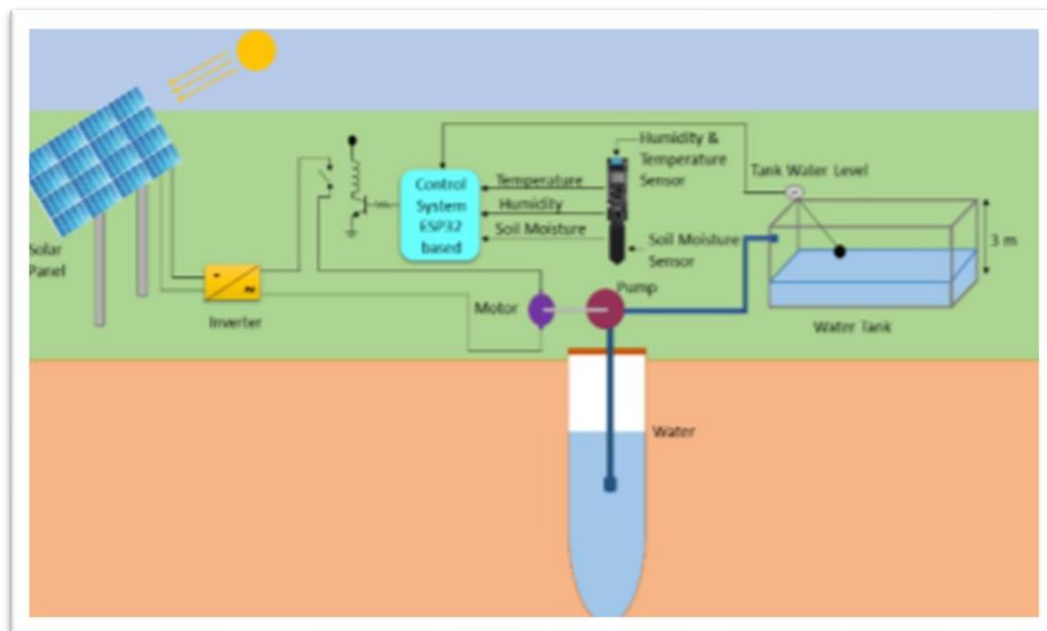

Figure 2.12. : System design of the research paper

- This paper affords a low fee cheap automatic water pumping device made with the help of Esp32 microcontroller in combination with the Arduino Iot Cloud which is used for irrigation purpose in various parts of the world or crop growing regions in the world.
- The programmed sensor module detects the temperature, humidity, soil moisture degree and further the recorded data or the figures are sent to the EsP 32 chip for displaying the figures on the connected desktop or the cell phone with the help of the Bluetooth.
- A water degree sensor is additionally observes the water degree and sends the records or the figures to the microcontroller unit. Further the data recorded and the figures visualized the ESP32 Microcontroller chip comes to the to either start or stop the motor which is setup in the fields.
- This paper additionally describes a way to determine how the soil moisture shows the type of soil and further check whether the soil id good or bad for the crops to be grown

the outcomes or the results are sent by the ESP32 chip to perform the irrigation activities for the crops to provide good results .

- Thus this system can also be operated remotely as on our cell phones while providing a ON/Off button on it in order to control the pumping of the water for the irrigation.

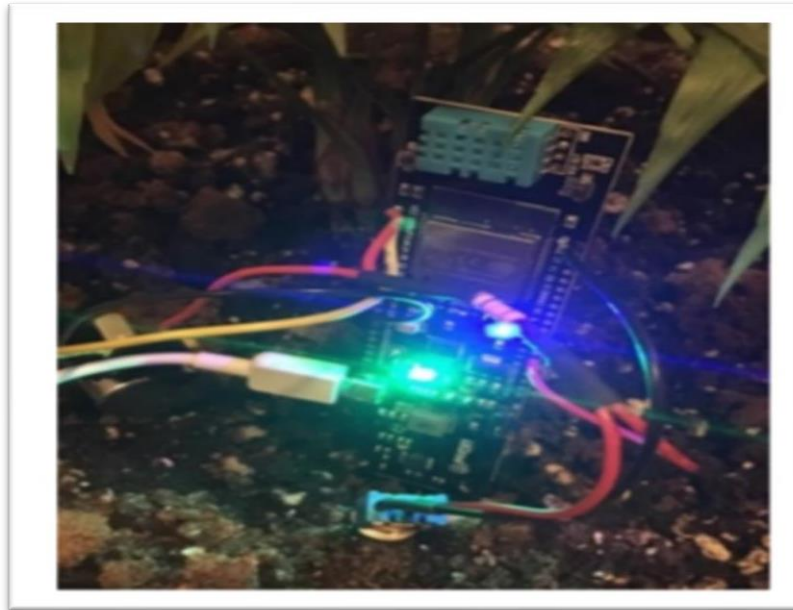

Figure 2.13 : Depicts the testing of the soil Practically

- A water degree sensor is additionally observes the water degree and sends the records or the figures to the microcontroller unit. Further the data recorded and the figures visualized the ESP32 Microcontroller chip comes to the to either start or stop the motor which is setup in the fields.
- This paper additionally describes a way to determine how the soil moisture shows the type of soil and further check whether the soil is good or bad for the crops to be grown

CHAPTER 3: SYSTEM DEVELOPMENT

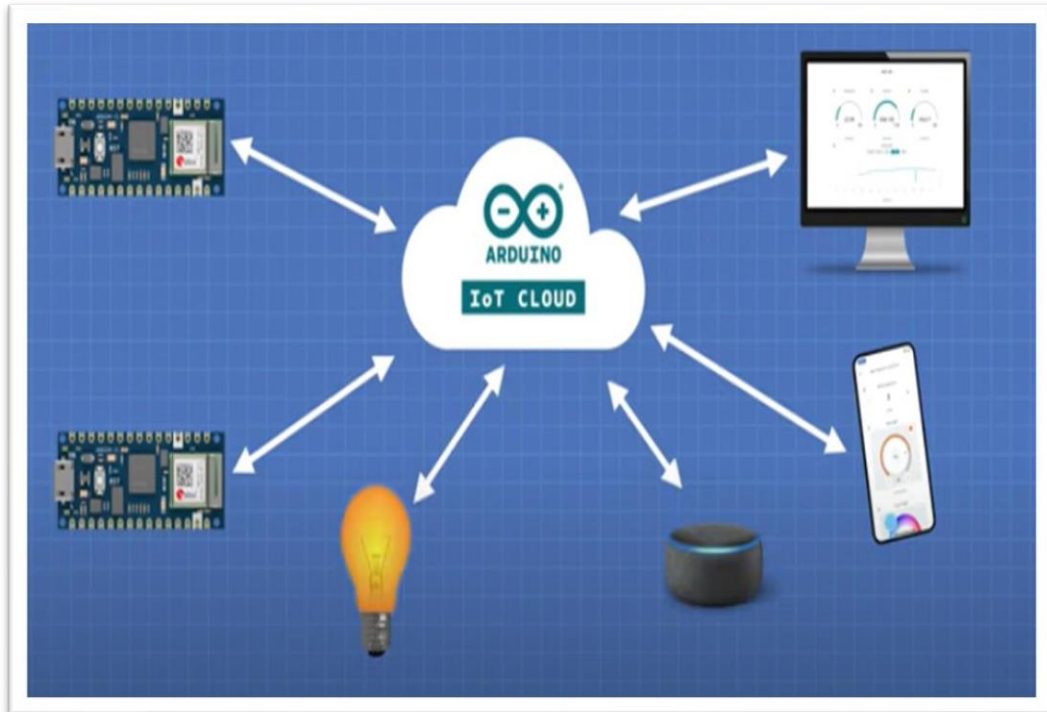

Figure 3.1 : Analysis of the project

- Arduino Iot Cloud Application a product of itself, where we would be able to provide or initiate the code template in the Arduino Iot cloud within it , followed by the editing and the uploading of the code to the board using the Arduino Web Editor. Also In Recent times Arduino cloud also added support system for various hardware objects like ESP32 boards , sensors for easy development of the setup and to make the Iot Cloud work efficiently.
- ESP32 Board is basically a microcontroller chip which is used for the working of the Iot Cloud efficiently with the powerful Wi-Fi+ Bluetooth/Bluetooth LE targeting the various Iot Applications and projects.
- The Arduino IoT Cloud is designed to assist humans with the upcoming new technologies. It basically is designed recently in order to make use of a software instead of hardware's for easiness and affordable prize for the coming time. It create things with easiness .

- It basically is designed recently in order to make use of a software instead of hardware's for easiness and affordable prize for the coming time. It create thingswith easiness .
- The main step is an easy way just like connecting a device to a Bluetooth , where creating and developing the variables and a dashboard to visualize it can make your half steps done.
- As we create a Thing, a sketch is generated automatically , and updates with all modifications we make withinside the cloud.
- By making this task we are able to discover ways to study water quality management system so that the main concern for todays and future generations to stop polluting water bodies instead start saving and help all living beings lead a healthy and sustained life. This is only possible if the consumption of water of all living beings be it humans, animals and plants is monitored in various conditions with this Arduino Iot Cloud Application is used to monitor and keep it as a record.
- Monitoring the records at the desktop to be had withinside the Arduino Iot Cloud And ESP32 microcontroller to communicate/ speak with the Arduino Cloud IoT using on/off Led lights.
- DS18B20 Temperature Sensor: digital waterproof temperature sensor is a digitally calibrated tool which is basically used for the temperature sensing which is used for the things which indulge in water activities.



Figure 3.2: DS18B20 Temperature sensor (waterproof)

- ESP32: it is a low-cost, low-power system on a chip microcontroller with integrated Wi-Fi and dual - mode Bluetooth. ESP32 borad

- Resistors : resistors are used to reduce current flow, adjust signal levels
- Connecting Wires: used to connect the setup
- Breadboard: A thin plastic board used to hold electronic components.
- TDS Sensor : measuring TDS value of the water. It can be applied to domestic water, hydroponic and other fields of water testing

TDS is basically Total Dissolved Solids which refers to the total concentration of dissolved and mixed substances in drinking water or natural water in order to check the quality of water. TDS includes inorganic salts organic salts and the other amount of organic substances.

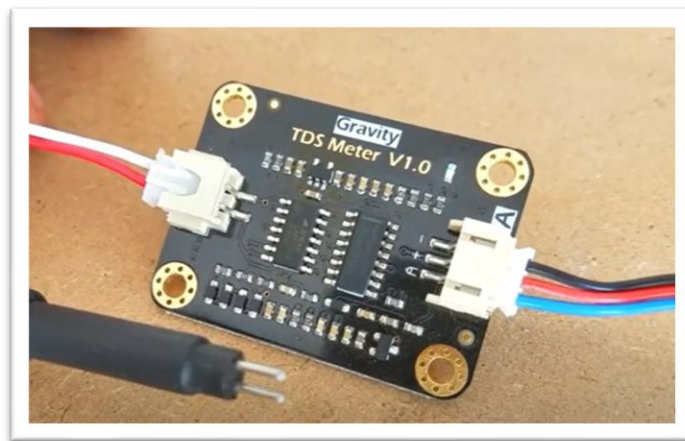

Figure 3.3 : TDS sensor used to detect the Total Dissolved Solids

- Electrical Conductivity of water is basically being carried out in the project in order to detect the purity of water through the TDS value. The ability to conduct an electric current in the testing of water quality where the Salts or other chemicals that are dissolved in water can be measured with the help of the concept of the breaking down of the charged ions into positively and negatively charged ions. The movable ions in the water helps us to conduct electricity where the water's electrical conductivity depends on the concentration of ions. Total dissolved solids (TDS) and the salts present are used to calculate the E Conductivity of water. Which helps us to check the purity of water The purer the water, the lower the conductivity. Example distilled water is an insulator, but salt water is a very efficient electrical conductor.

3.1 Design

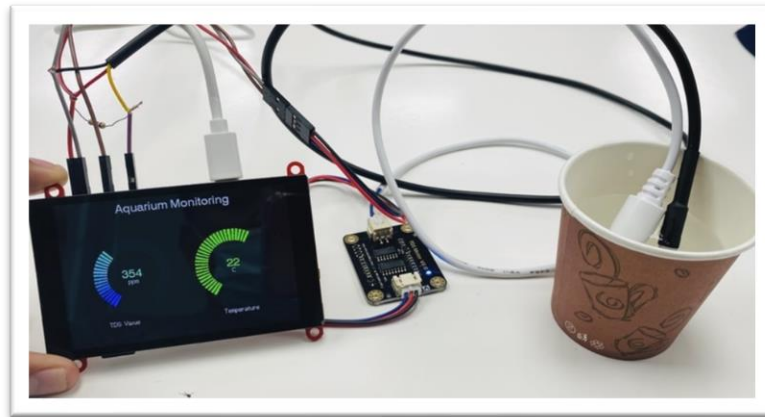

Figure 3.4 System design of the project

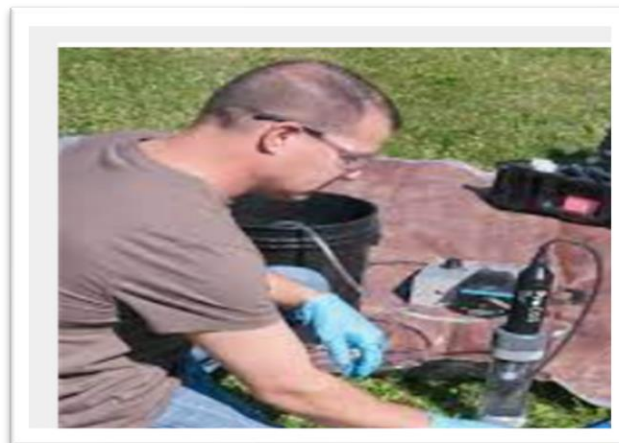

Figure 3.5: Depicts the Measurement of water quality being done through the sensor tool made

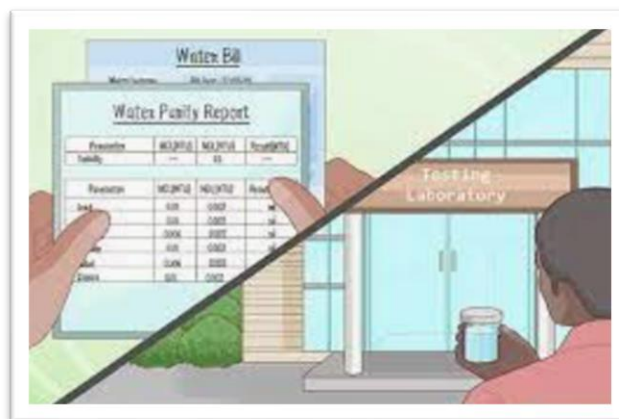

Figure 3.6: shows the design of the water purity/ quality report

Hardware and Software Required:

- 1) **Arduino iot Cloud:** is an application that helps makers build connected objects in a quick, easy and secure way. We can connect multiple devices to each other and allow them to exchange real-time data. We can also monitor them from anywhere using a simple user interface.
- 2) **DS18B20 Temperature Sensor:** digital waterproof temperature sensor is a digital signal output with a calibrated temperature of water.



Figure 3.7: DS18B20 Temp Sensor

- 3) **ESP32:** it is a series of low-cost, low-power system on a chip microcontroller with integrated Wi-Fi and dual - mode Bluetooth.



Figure 3.8: ESP32 component

- 4) **TDS Sensor** : measuring TDS value of the water. It can be applied to domestic water, hydroponic and other fields of water.



Figure 3.9: TDS sensor

- 5) **Resistors** : A resistor is a passive two-terminal electrical component that implements electrical resistance as a circuit element. We will be using 4.7k resistor.



Figure 3.10: 4.7k resistor

- 6) **Jumper Wires**: used to connect the setup. We will be using Female to Female jumper wires.



Figure 3.11: Jumper wires

- 7) **Breadboard**: A thin plastic board used to hold electronic components.

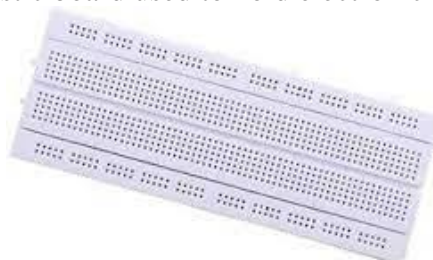

Figure 3.12: Breadboard

- The main step is as easy as connecting a device to a Bluetooth , where creating and developing the variables and a dashboard to visualize it can make your half steps done.
- As we create a Thing, as in the application of Arduino Iot cloud a sketch is generated automatically as a part of the software programming , and updates with all modifications we make withinside the cloud.
- The Arduino IoT Cloud is designed to assist humans with the upcoming new technologies. It basically is designed recently in order to make use of a software instead of hardware's for easiness and affordable prize for the coming time .It create things with easiness .
- By making this task we are able to discover ways to study water quality management system so that the main concern for todays and future generations to stop polluting water bodies instead start saving and help all living beings lead a healthy and sustained life. This is only possible if the consumption of water of all living beings be it humans, animals and plants is monitored in various conditions with this Arduino Iot Cloud Application is used to monitor and keep it as a record.
- Monitoring the records at the desktop to be had withinside the Arduino Iot Cloud And ESP32 microcontroller to communicate/ speak with the Arduino Cloud IoT using on/off Led lights.
- Electrical Conductivity of water is basically being carried out in the project in order to detect the purity of water through the TDS value. The ability to conduct an electric current in the testing of water quality where the Salts or other chemicals that are dissolved in water can be measured with the help of the concept of the breaking down of the charged ions into positively and negatively charged ions. The movable ions in the water helps us to conduct electricity where the water's electrical conductivity depends on the concentration of ions. Total dissolved solids (TDS) and the salts present are used to calculate the E Conductivity of water. Which helps us to check the purity of water The purer the water, the lower the conductivity. Example distilled water is an insulator, but salt water is a very efficient electrical conductor.

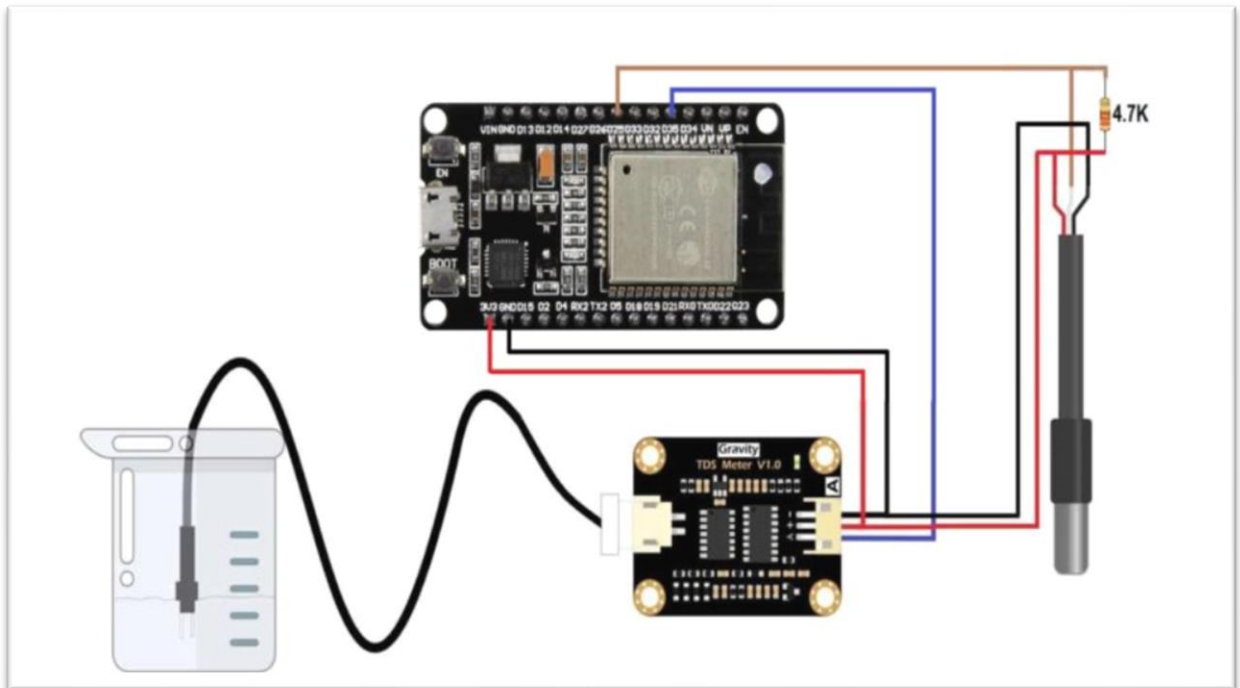

Figure 3.13 showing the connections for interfacing of sensors

- In this project, we have build Water Quality Monitor System with TDS Sensor & ESP32.
- We have displayed the real-time value of Water TDS and Temperature on the Arduino Iot Cloud Application.
- TDS Sensor and DS18B20 Waterproof Temperature Sensor are used in this project for measuring TDS value of the water And temperature accordingly.
- The best thing about the project is the use of Arduino iot cloud lcd embedded with ESP32 which helped us in monitoring the live data in real time.
- Also the previous values are recorded for the better monitoring of the data.
- By making this task we are able to discover ways to study water quality management system so that the main concern for todays and future generations to stop polluting water bodies instead start saving and help all living beings lead a healthy and sustained life. This is only possible if the consumption of water of all living beings be it humans, animals and plants is monitored in various conditions with this Arduino Iot Cloud Application is used to monitor and keep it as a record.

Connections used in this project are as follows :

TDS connections with ESP32:

- 1) VCC to 3.3V
- 2) Output to IO35
- 3) GND to GND

Temp Sensor connections with ESP32:

- 1) GND to GND
- 2) VCC to VCC
- 3) Signal pin to one end of 4.7k resistor and IO25 pin of ESP32 to another end of the resistor

A 4.7k resistor is also required for connecting.

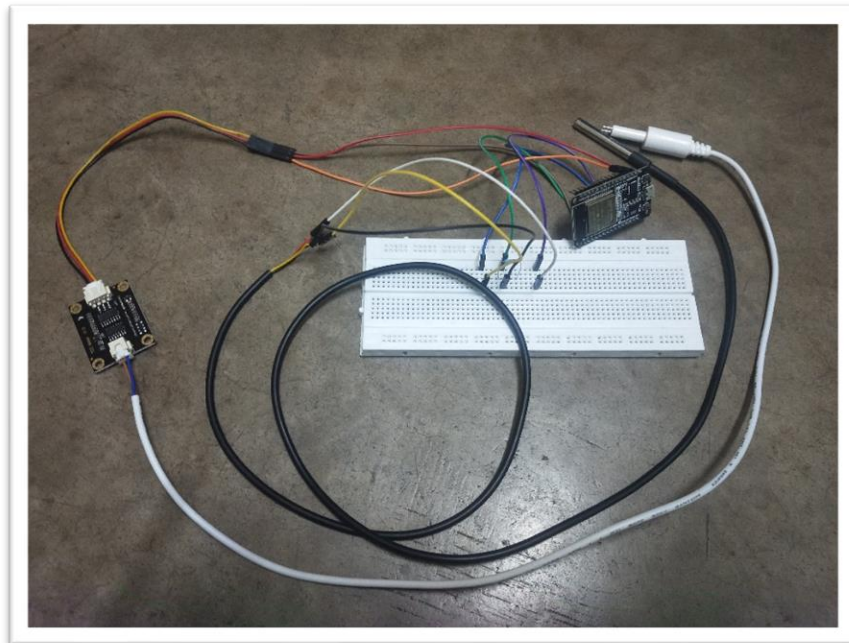

Figure 3.14: showing the connections

3.2 Block Diagram

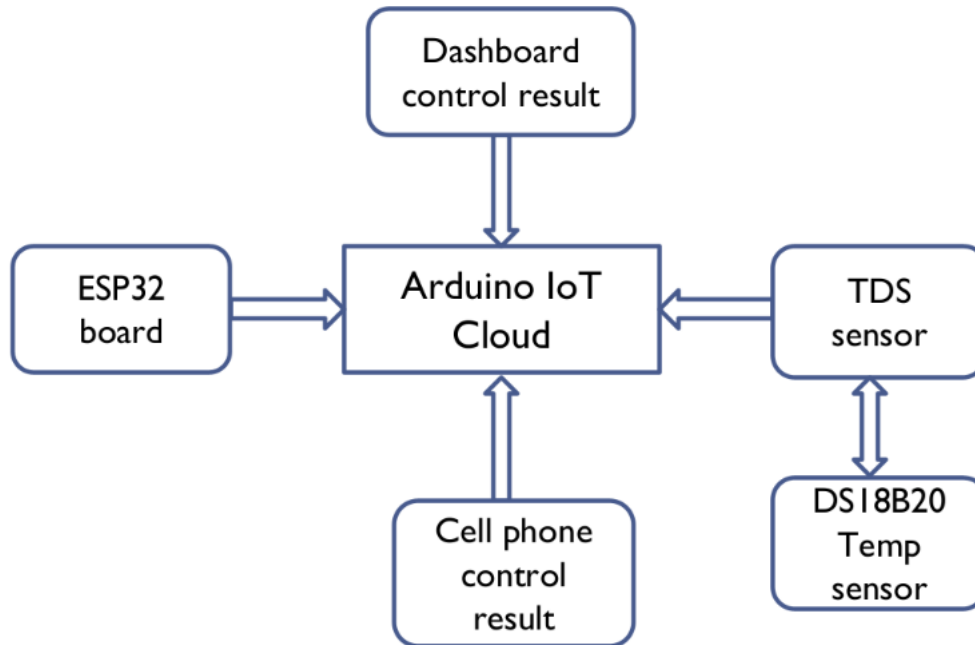

Figure 3.15: Block Diagram of the project

Step 1: Configuring Arduino Iot Cloud Dashboard and creating variables like Temperature , Humidity and Led1.

Step 2: Backend installation are being carried out and further creating the agent to the Arduino Iot Cloud application as well as Testing the setup on Web Dashboard by checking this out through sending a random value from the board to the cloud, and through developing the on/off an led at the board with the help of the cloud .

Step 3: Adding ESP32 ,TDS Sensor, Temperature Sensor, ESP32 WIFI Module & Arduino Iot Display device in Arduino Iot Cloud.

Step 4: The final and the main step is the Setting of the Arduino Iot cloud remote app on cell phone and checking the setup Monitoring the water quality /purity and working of the led bulbs.

3.3 Algorithm

Step 1: START

Step 2: Define variables (TDS Value, temp, led)

Step 3: #include "thingsPropertiies.h" and #include "temp"

Step 4: Define temp signal pin i.e pin 25 and also define the temp type i.e TEMP

Step 5: Serial.begin and temp.begin

Step 6: define LED function and write code to act upon LED change.if(LED==1)

```
{ digitalWrite(2,HIGH) }else
```

```
{ (digitalWrite(2, LOW) }
```

Step 7: define function to read temp sensor and write code to read and print the live data.

```
void TEMP_SENSOR_READ()
```

```
{
```

```
float h = temp.reaadHumidity(); float t = temp.reaadTemperature();temperature = t;
```

```
humidity = h;
```

```
Serial.printt("Temperature - "); Serial.println(t);Serial.printt("Humidity - ");
```

```
Serial.println(h); delay(1000);
```

```
}
```

Step 8: END

Explanation of the algorithm:

Step 1: Configuring Arduino Iot Cloud Dashboard and creating variables like Temperature , TDS and Led1.

Step 2: Backend installation are being carried out and further creating the agend to the Arduino Iot Cloud application as well as Testing the setup on Web Dashboard by checking this out through sending a random value from the board to the cloud, and through developing the on/off an led at the board with the help of the cloud .

Step 3: Adding ESP32 and TDS Sensor device in Arduino Iot Cloud with installation of WIFI and Bluetooth Widgets to the cloud with the help of ESP32 chip board.

Step 4 : By making this task we are able to discover ways to study water quality management system so that the main concern for todays and future generations to stop polluting water bodies instead start saving and help all living beings lead a healthy and sustained life. This is only possible if the consumption of water of all living beings be it humans, animals and plants is monitored in various conditions with this Arduino Iot Cloud Application isused to monitor and keep it as a record.

Step 5 : Monitoring the records at the desktop to be had withinside the Arduino Iot Cloud AndESP32 microcontroller to communicate/ speak with the Arduino Cloud IoT using on/off Led lights.

Step 6 : Electrical Conductivity of water is basically being carried out in the project inorder to detect the purity of water through the TDS value. The ability to conduct an electric current in the testing of water quality where the Salts or other chemicals that are dissolved in water can be measured with the help of the concept of the breaking down of the charged ions into positively and negatively charged ions. The movable ions in the water helps us to conduct electricity where the water's electrical conductivity depends on the concentration of ions. Total dissolved solids (TDS) and the salts present are used to calculate the E Conductivity of water. Which helps us to check the purity of water The purer the water, the lower the conductivity. Example distilled water is an insulator, but salt water is a very efficient electrical conductor.

3.4 Model Development

- Arduino Iot Cloud Application a product of itself, where we would be able to provide or initiate the code template in the Arduino Iot cloud within it , followed by the editing and the uploading of the code to the board using the Arduino Web Editor. Also In Recent times Arduino cloud also added support system for various hardware objects like ESP32 boards , sensors for easy development of the setup and to make the Iot Clo work efficiently.
- ESP32 Board is basically a microcontroller chip board which is used for the working of the Iot Cloud efficiently with the powerful Wi-Fi+Bluetooth/Bluetooth LE targeting the various Iot Applications and projects.
- DS18B20 Temperature Sensor: digital waterproof temperature sensor is a digital signal output with a calibrated temperature of water. As concerned with the project the main aim is to monitor the water quality management system as temperature plays a major role in quality check.
- The main step is as easy as connecting a device to a Bluetooth , where creating and developing the variables and a dashboard to visualize it can make your half steps done.

As we create a Thing, as in the application of Arduino Iot cloud a sketch is generated automatically as a part of the software programming , and updates with all modifications we make withinside the cloud. .

- By making this task or project we are able to discover ways to study and monitor the quality of water .
- By making this task we are able to discover ways to study water quality management system so that the main concern for todays and future generations to stop polluting water bodies instead start saving and help all living beings lead a healthy and sustained life. This is only possible if the consumption of water of all living beings be it humans, animals and plants is monitored in various conditions with this Arduino Iot Cloud Application .

CHAPTER 4 : PERFORMANCE ANALYSIS

4.1 Experimental Analysis (step by step)

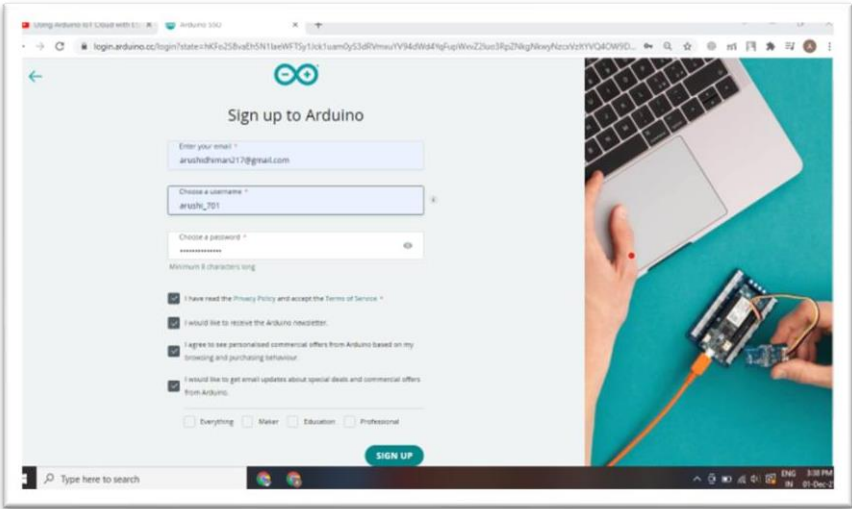

Figure 4.1: Setup to the Auruino Iot Cloud

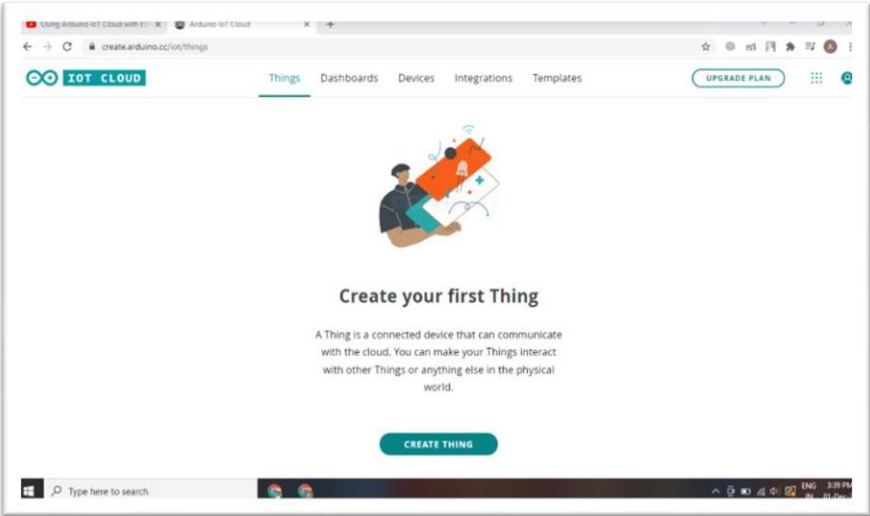

Figure 4.2: Creating things in the application

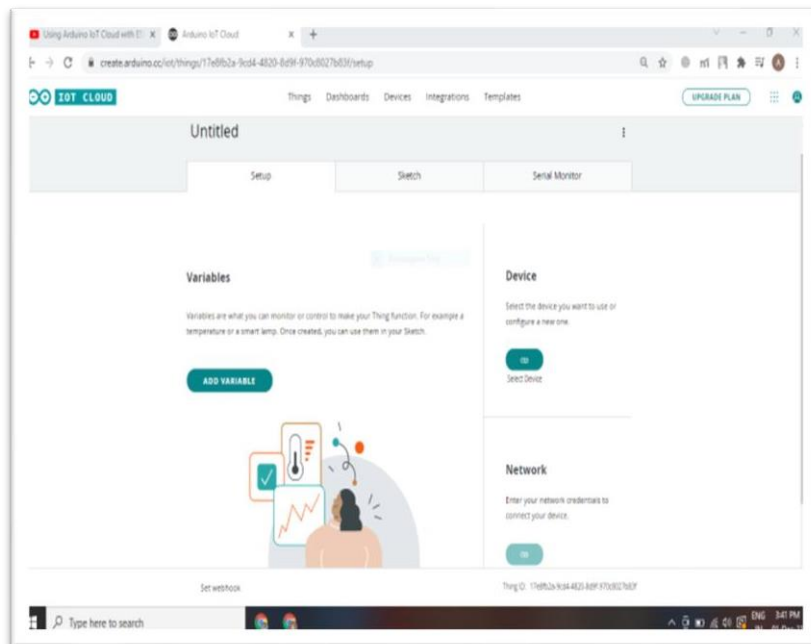

Figure 4.3: Adding Variables to the application

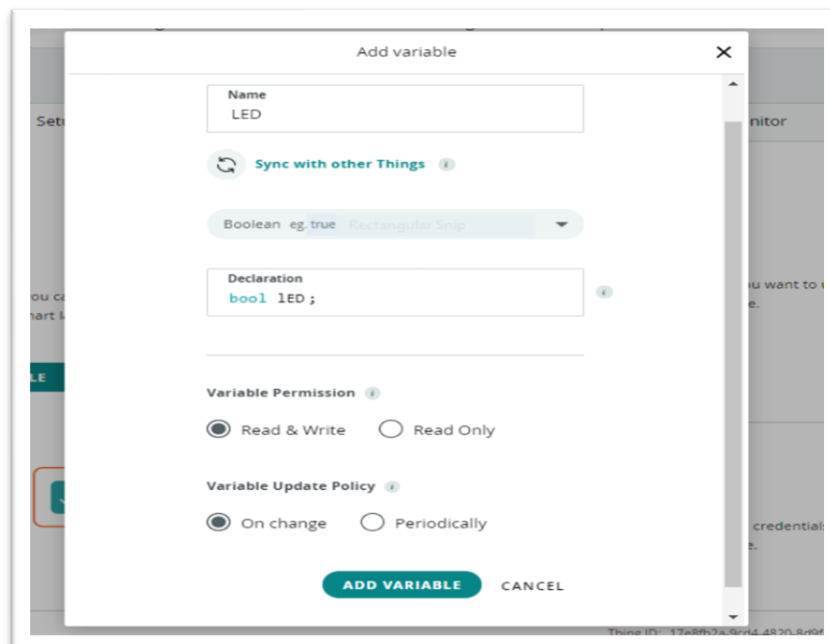

Figure 4.4: Adding the First Variable as LED

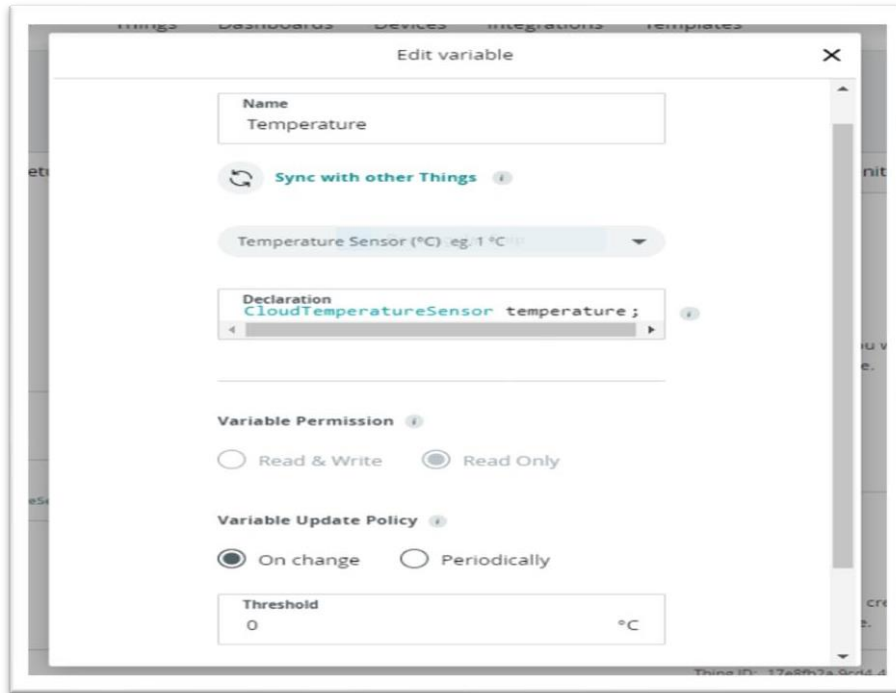

Figure 4.5: Adding Second Variable as Temperature

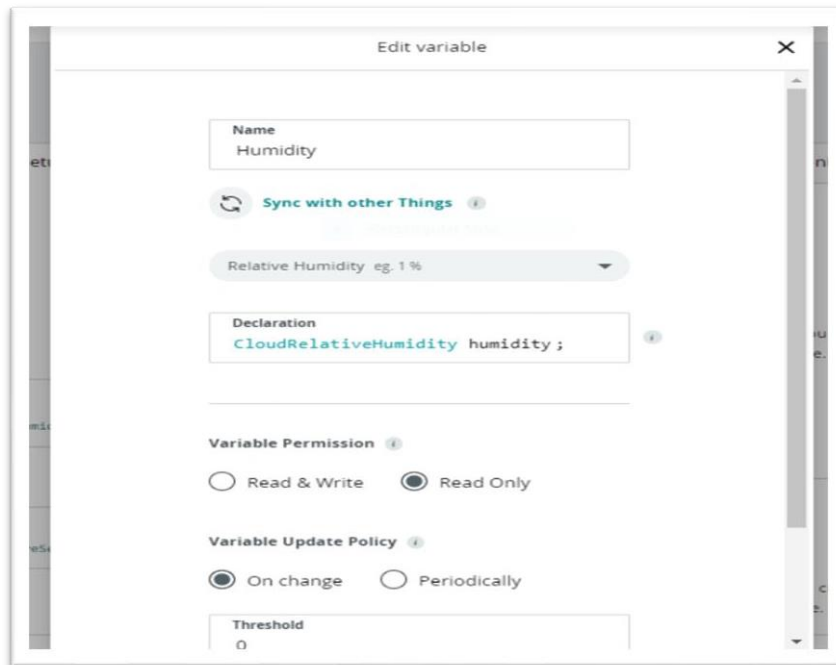

Figure 4.6: Adding the Third variable Humidity

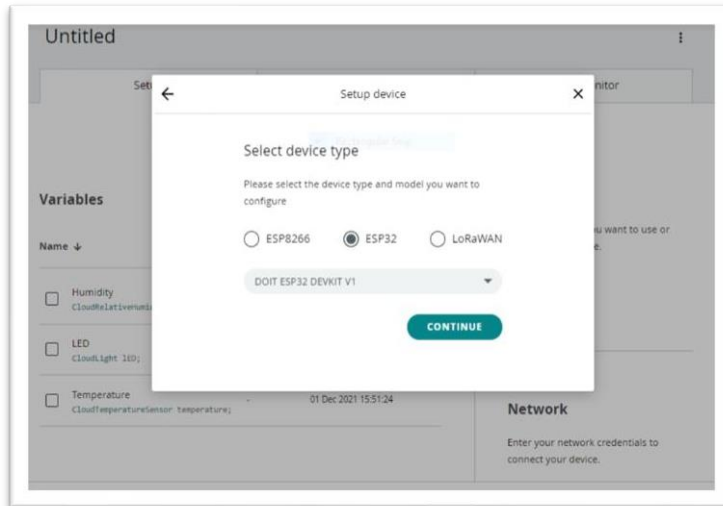

Figure 4.7: adding and linking the device i.e ESP32

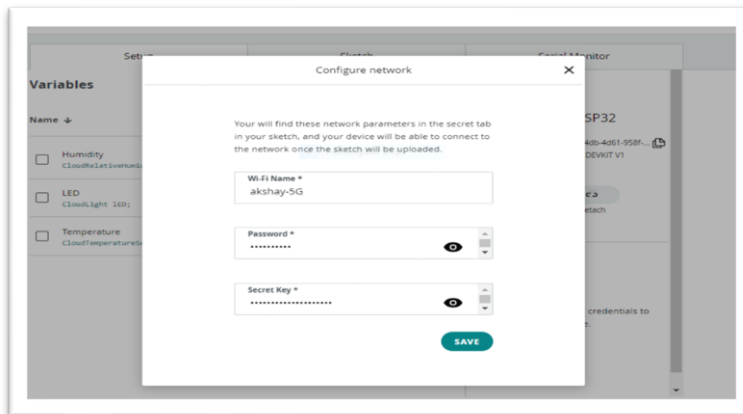

Figure 4.8: adding and linking the WIFI Network

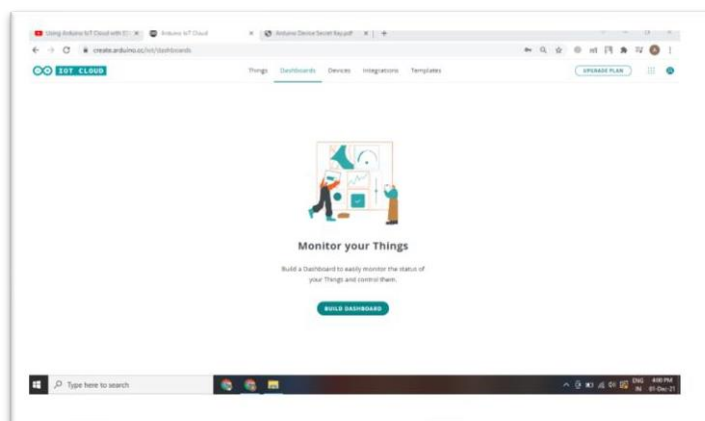

Figure 4.9: Dash-board

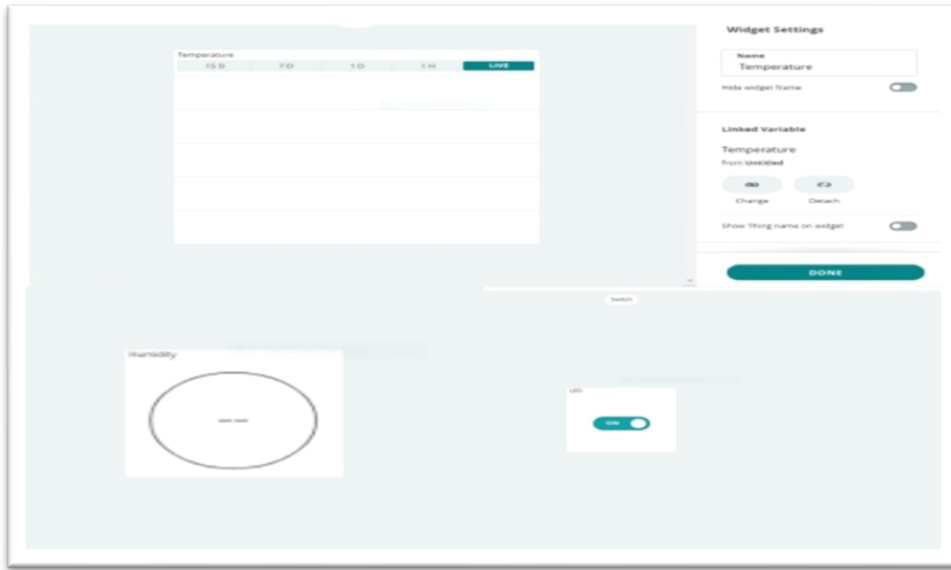

Figure 4.10: Widgets for Led Temperature and humidity

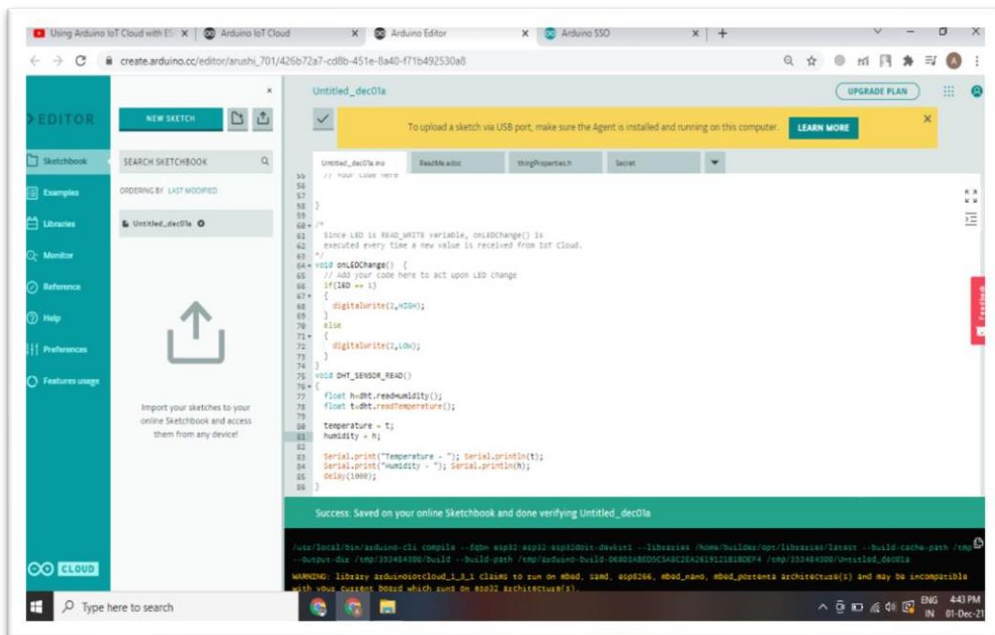

Figure 4.11: Compilation of code

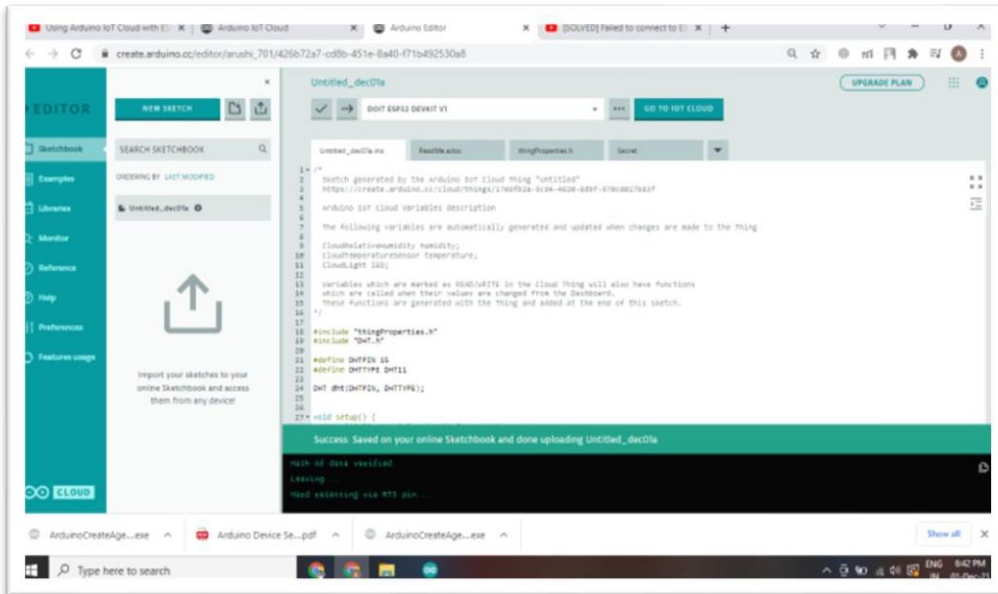

Figure 4.12: Code Uploading to ESP32

4.2 Results

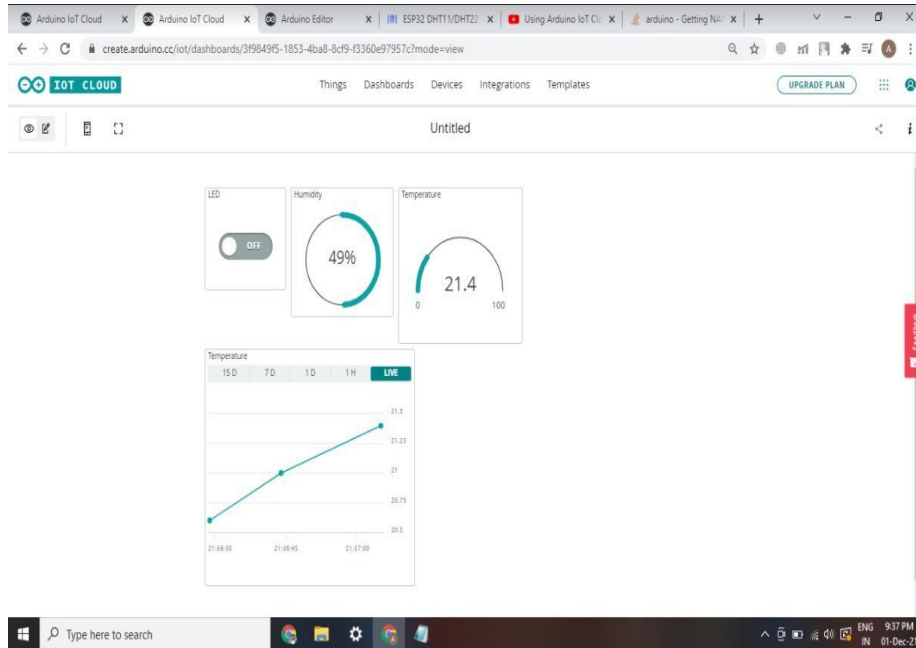

Figure 4.13: Desktop output



Figure 4.14: Cell Phone results show humidity and temperature

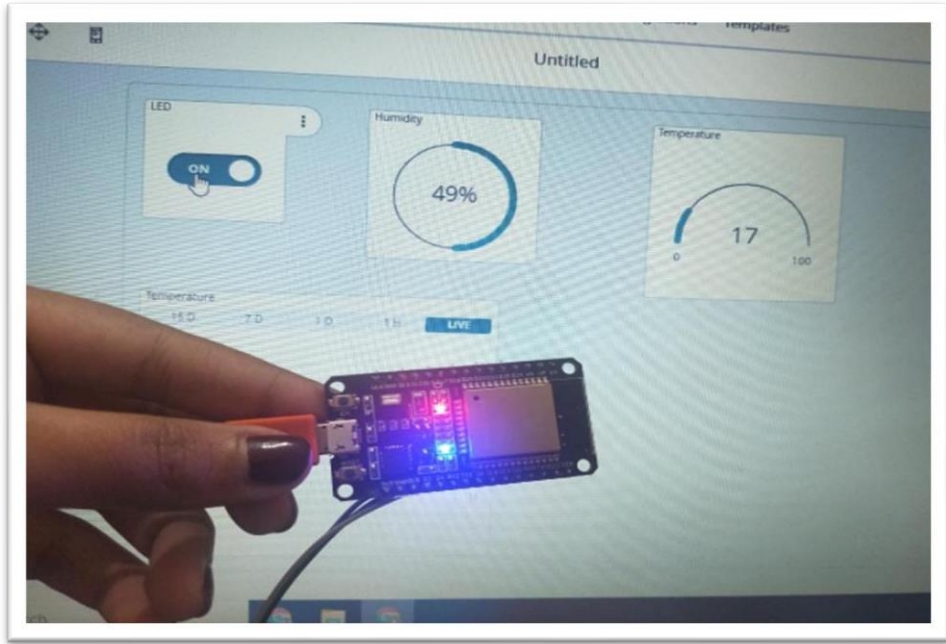

Figure 4.15: Setup model Results



Figure 4.16: water purity regulating system

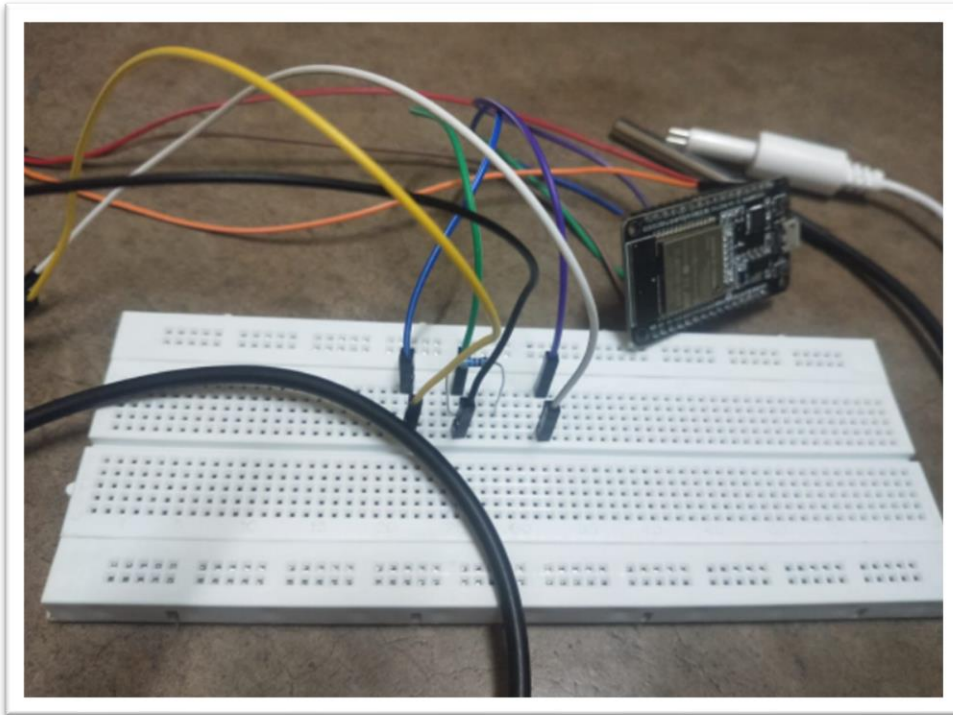

Figure 4.17: Connections made for the project

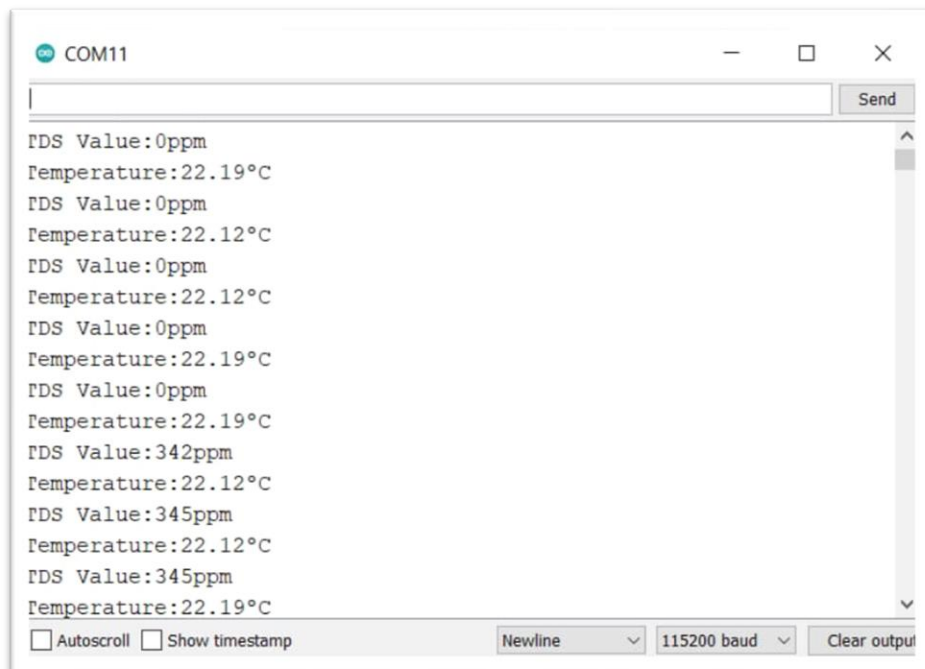

Figure 4.18: output results of measuring TDS value , and water temperature

CHAPTER 5: CONCLUSION

5.1 Conclusion

The utmost goal of this project is to use current advanced technologies to read the real time environmental data. Such as temperature/ humidity and Water purity, using ESP32,DHT11 and TDS sensor as well as DS18B20 Temperature Sensor to visualize data on the widgets available in the arduino iot cloud and displaying it on the desktop screen and also in our cell phones using dashboard. We will be able to monitor the real time data from anywhere as we are also connecting the whole setup with our mobile phones.

Along with this the goal is also to get familiar with the Arduino Iot cloud platform and to learn and explore more of it.

By making this task we are able to discover ways to study the temperature and humidity from DHT11 sensor of the soil. Soil as an environmental issue where growing crops in worst climatic conditions is being the recent challenge in various parts of the world thus as for checking the fertility of soil like the temperature as well as the humidity for the productiveness of the crops in various conditions this Arduino Iot Cloud Application is used to monitor and keep it as a record. As we both the member of this group submitting the project belong to Himachal Pradesh which is a renowned state for its crops and various vegetation . so the need of this equipment is in current urge by noticing the drastic climatic changes happening all over the state. The condition of the soil matters as in winters the temperature and humidity level varies that affect the crops as well as its growth .

So with help of this system we can regularly monitor the conditions of the soil as well as our home which would help us in monitoring and analysing the environmental data. By making this task we are able to discover ways to study the temperature and humidity from DHT11 sensor of the soil. Soil as an environmental issue where growing crops in worst climatic conditions is being the recent challenge in various parts of the world thus as for checking the fertility of soil like the temperature as well as the humidity for the productiveness of the crops in various conditions this Arduino Iot Cloud Application is used to monitor and keep it as a record.



Figure 5.1: shows the output of the project

5.2 Future Scope

The utmost goal of this project is to use current advanced technologies to read the realtime environmental data such as temperature and humidity, using ESP32, waterproof temp sensor and TDS. Also to visualize data on the widgets available in the arduino iot cloud and displaying it on the desktop screen and also in our cell phones using ESP32 through wifi Bluetooth.

We will be able to monitor the real time data from anywhere as we are also connecting the whole setup with our mobile phones.

Our Future work will be in addition to this project where we will be going to collect the live recent environmental data and try to deploy that environmental data collection as the output with the help of Arduino Iot Cloud Application and ESP32 Microcontroller chip.

Along with the deployment of the environmental data we will also add an application to the project which will be the home automation system where the system will be as follows. So with help of this system we can regularly monitor the conditions of the soil as well as our home which would help us in monitoring and analysing the environmental data. By making this task we are able to discover ways to study the temperature and humidity from the sensor of the soil. Soil as an environmental issue where growing crops in worst climatic conditions is being the recent challenge in various parts of the world thus as for checking the fertility of soil like the temperature as well as the humidity for the productiveness of the crops in various conditions this Arduino Iot Cloud Application is used to monitor and keep it as a record.

Volume 13: 4 Issues (2022): Forthcoming, Available for Pre-Order
Volume 12: 4 Issues (2021)
Volume 11: 4 Issues (2020)
Volume 10: 4 Issues (2019)
Volume 9: 4 Issues (2018)
Volume 8: 4 Issues (2017)
Volume 7: 4 Issues (2016)
Volume 6: 4 Issues (2015)
Volume 5: 4 Issues (2014)
Volume 4: 4 Issues (2013)
Volume 3: 4 Issues (2012)
Volume 2: 4 Issues (2011)
Volume 1: 4 Issues (2010)

Figure 5.2: Depiction of the environmental data on the Cloud App

- The system is designed as per the basic requirements in our middle class requirements so that each and every part of the society can embrace the opportunity of the project when in market .The advantages of making such projects are as follows
 - a. user-friendly
 - b. low power consumption
 - c. low cost
 - d. allowing users to use a traditional thermostat
 - e. to monitor the room
 - f. ambient temperature
 - g. and to control the thermostat settings locally and remotely.



Figure 5.2: Depicts the Home automation system

5.3 Applications

1. IoT based Air Quality Index Monitoring using ESP32
 - Pollution impacts our health as well as causes major environmental changes like Global warming and weather variations or conditions.
 - There is a need to constantly measure, analyze and monitor the air quality on areal-time basis so that appropriate measures can be taken whenever needed.
 - For this, the proposed model deals with the concept of the Internet of Things to let the user/or the monitor know about the concentration of harmful gases present around him and thus letting the user know the quality of air. In addition to this giving us figures of the regular recorded temperature as well as humidity for the exact monitoring of the air quality

2. Home Automation
 - We are living in the fourth industrial revolution and with this changing scenario of the world and upcoming new technologies our life is becoming more comfortable and smarter .
 - Just with the help of continuous upgradation and with the coming new generations of technology. The paper have been introduced for the clarification of the newly updated technology i.e Arduino Iot Cloud Application which is an easier version of the Arduino hardware used to Make Iot projects . As it's a software application thus provides us with the cheaper as well as most accessible in terms of Iot Projects .
 - In this paper, we present an IoT based low-cost smart home automation system.
 - This system is based on a web portal with further usage of an ESP32 Wi-Fi module which is the controller of the setup. Also, a private home web server is developed which is used for maintaining the home appliances like the bulb , led ON/OFF , AC , Television etc

3. A Remote Thermostat Control And Temperature Monitoring System

- With the newly updated Arduino Iot Cloud another application of the remote thermostat was introduced by the EJECE where they introduced the cloud application to the platform named openHAB which is basically a clever domestic automation is used as a domestic server which is used here for the remote smart thermostat .
- The essential goals of this project are the layout at a low-price tracking and manipulate the device for thermal strength structures to screen as well as monitor the real-time temperature data and records, further the design the control device for thermostat settings with the subsequent functions including manual/computerized operations, local/faraway manipulate options.

4. Solar Water Pumping System Control Using A Low Cost ESP32 Microcontroller

- This paper affords a low fee cheap automatic water pumping device made with the help of Esp32 microcontroller in combination with the Arduino Iot Cloud which is used for irrigation purpose in various parts of the world or crop growing regions in the world.
- The programmed sensor module detects the temperature, humidity, soil moisture degree and further the recorded data or the figures are sent to the EsP32 chip for displaying the figures on the connected desktop or the cell phone with the help of the Bluetooth.
- A water degree sensor is additionally observes the water degree and sends the records or the figures to the microcontroller unit. Further the data recorded and the figures visualized the ESP32 Microcontroller chip comes to the to either start or stop the motor which is setup in the fields.
- The essential goals of this project are the layout at a low-price tracking and manipulate the device for thermal strength structures to screen as well as monitor the real-time temperature data and records, further the design the control device for thermostat settings with the subsequent functions including manual/computerized operations, local/faraway manipulate options.

REFERENCES

- 1) S Mahetaliya, D Makwana, A Pujara - 2021 - svv-research-data.s3.ap-south-1.
https://svv-research-data.s3.ap-south-1.amazonaws.com/paper_160126_1620225357.pdf
- 2) M. S. Mahamud, M. S. R. Zishan, S. I. Ahmad, A. R. Rahman, M. Hasan and M. L. Rahman, "Domicile - An IoT Based Smart Home Automation System," 2019 International Conference on Robotics,Electrical and Signal Processing Techniques (ICREST), 2019, pp. 493-497, doi: 10.1109/ICREST.2019.8644349.
<https://ieeexplore.ieee.org/abstract/document/8644349>
- 3) S. Bipasha Biswas and M. Tariq Iqbal, "Solar Water Pumping System Control Using a Low Cost ESP32 Microcontroller," *2018 IEEE Canadian Conference on Electrical & Computer Engineering (CCECE)*, 2018, pp. 1-5, doi: 10.1109/CCECE.2018.8447749.
<https://ieeexplore.ieee.org/abstract/document/8447749>
- 4) B. I. Bakare, V. E. Idigo, S. U. Nnebe Vol 4 No 5 (2020) EJEC
<https://ejece.org/index.php/ejece>
- 5) <https://create.arduino.cc/projecthub/magicbit0/arduino-iot-cloud-with-esp32-6190c7>
- 6) <https://create.arduino.cc/projecthub/148064/your-environmental-data-on-arduino-iot-cloud-4e29bf>

APPENDICES

CODE:

```
#include <OneWire.h>
#include <DallasTemperature.h>

const int oneWireBus = 25; // GPIO where the DS18B20 is connected to

#define TdsSensorPin 35
#define VREF 3.3 // analog reference voltage(Volt) of the ADC
#define SCOUNT 30 // sum of sample point
int analogBuffer[SCOUNT]; // store the analog value in the array, read from ADC
int analogBufferTemp[SCOUNT];
int analogBufferIndex = 0;
int copyIndex = 0;
float averageVoltage = 0;
float tdsValue = 0;
float temperature = 0;

OneWire oneWire(oneWireBus); // Setup a oneWire instance to communicate with
any OneWire devices

DallasTemperature sensors(&oneWire); // Pass our oneWire reference to Dallas
Temperature sensor

void setup()
{
  Serial.begin(115200);
  pinMode(TdsSensorPin, INPUT);
  sensors.begin();
}

void loop()
{
  sensors.requestTemperatures();
  float temperature = sensors.getTempCByIndex(0);

  static unsigned long analogSampleTimepoint = millis();
  if (millis() - analogSampleTimepoint > 400) //every 400 milliseconds,read the analog
value from the ADC
  {
    analogSampleTimepoint = millis();
    analogBuffer[analogBufferIndex] = analogRead(TdsSensorPin); //read the analog
value and store into the buffer
    analogBufferIndex++;
    if (analogBufferIndex == SCOUNT)
      analogBufferIndex = 0;
  }
}
```

```

}
static unsigned long printTimepoint = millis();
if (millis() - printTimepoint > 800U)
{
    printTimepoint = millis();
    for (copyIndex = 0; copyIndex < SCOUNT; copyIndex++)
        analogBufferTemp[copyIndex] = analogBuffer[copyIndex];
    averageVoltage = getMedianNum(analogBufferTemp, SCOUNT) * (float)VREF /
1024.0; // read the analog value more stable by the median filtering algorithm, and
convert to voltage value
    float compensationCoefficient = 1.0 + 0.02 * (temperature - 25.0); //temperature
compensation formula: fFinalResult(25°C) = fFinalResult(current)/(1.0+0.02*(FTP-
25.0));
    float compensationVolatge = averageVoltage / compensationCoefficient;
//temperature compensation
    tdsValue = (133.42 * compensationVolatge * compensationVolatge *
compensationVolatge - 255.86 * compensationVolatge * compensationVolatge +
857.39 * compensationVolatge) * 0.5; //convert voltage value to tds value

    Serial.print("TDS Value:");
    Serial.print(tdsValue, 0);
    Serial.println("ppm");

    Serial.print("Temperature:");
    Serial.print(temperature);
    Serial.println("°C");
}
}
int getMedianNum(int bArray[], int iFilterLen)
{
    int bTab[iFilterLen];
    for (byte i = 0; i < iFilterLen; i++)
        bTab[i] = bArray[i];
    int i, j, bTemp;
    for (j = 0; j < iFilterLen - 1; j++)
    {
        for (i = 0; i < iFilterLen - j - 1; i++)
        {
            if (bTab[i] > bTab[i + 1])
            {
                bTemp = bTab[i];
                bTab[i] = bTab[i + 1];
                bTab[i + 1] = bTemp;
            }
        }
    }
}
if ((iFilterLen & 1) > 0)
    bTemp = bTab[(iFilterLen - 1) / 2];
else
    bTemp = (bTab[iFilterLen / 2] + bTab[iFilterLen / 2 - 1]) / 2;
return bTemp; }

```