

**PERFORMANCE ANALYSIS OF MIMO AND
COOPERATIVE MIMO TECHNIQUES IN
WIRELESS SENSOR NETWORKS**

Submitted in partial fulfillment of the Degree of
Bachelor of Technology



May – 2014

Enrollment. No. - 101076

Name of Student - GAURI MANI

Name of supervisor - Mr. KAUSHLENDRA PANDEY

DEPARTMENT OF ELECTRONICS AND
COMMUNICATION ENGINEERING
JAYPEE UNIVERSITY OF INFORMATION
TECHNOLOGY,
WAKNAGHAT

CERTIFICATE

This is to certify that project report entitled “**PERFORMANCE ANALYSIS OF MIMO AND COOPERATIVE MIMO TECHNIQUES IN WIRELESS SENSOR NETWORKS**” , submitted by **GAURI MANI (101076)** in partial fulfillment for the award of degree of Bachelor of Technology in Electronics and Communication Engineering to Jaypee University of Information Technology , Waknaghat , Solan has been carried out under my supervision. This work has not been submitted partially or fully to any other University or Institute for the award of this or any other degree or diploma.

Signature of Supervisor:

Name of the supervisor: Mr.Kaushlendra Kumar Pandey

Designation : Asst. Professor

Date :

ACKNOWLEDGEMENT

Apart from the efforts, the success of any project depends largely on the encouragement and guidelines of many others. Therefore I take the opportunity to express my gratitude to the people who have been instrumental in the successful completion of this project.

We would also like to show my appreciation to our project guide, **Mr. Kaushendra Kumar Pandey**, without his guidelines, tremendous support and continuous motivation the project work would not be carried out satisfactory. His kind behavior and motivation provided me the required courage to complete my project.

I would also like to thank our Director, Dean and Head of Department for their continuous support and guidance. Special thanks to our project panel because it was their concern and appreciation that made project carried out easily and satisfactorily.

GAURI MANI

(101076)

DATE

TABLE OF CONTENTS

TOPICS	Page No.
Summary	(iv)
List of Figures.....	(v)
List of Abbreviations.....	(vi)
<u>CHAPTER 1 : INTRODUCTION TO WIRELESS NETWORKS</u>	
1.1 Introduction.....	1
1.2 Applications.....	4
<u>CHAPTER 2 : THE MIMO WIRELESS CHANNEL</u>	
2.1 Introduction	6
2.2 Preliminaries.....	6
2.2.1 Multi antenna system.....	6
2.2.2 Array gain	7
2.2.3 Diversity gain	7
2.2.4 Spatial Multiplexing.....	8
2.2.5 Additional terms.....	9
2.3 Forms of MIMO	9
2.3.1 Multi antenna types.....	9
2.3.2 Multiple user types.....	10
2.4 Space-Time Block Code using Virtual Array Antenna.....	11
<u>CHAPTER 3: SYSTEM MODEL AND SIMULATION MODEL</u>	
3.1 Proposed System Model.....	14
3.1.1 Fixed Rate System.....	16
3.1.2 With Multinode Cooperation.....	19
3.2 Simulation Model In Matlab.....	22

CHAPTER 4 : ANALYSIS AND SIMULATION RESULT

4.1 Simulation Result.....23

CONCLUSION.....28

BIBLIOGRAPHY AND REFRENCES.....29

SUMMARY

The main limitation of the wireless sensor network is that it is a limited energy system, wireless nodes typically operate with small batteries for which replacement, when possible, is very difficult and expensive. Thus, the wireless nodes must operate without battery replacement for many years. Consequently, minimizing the energy consumption is a very important design consideration and energy-efficient transmission schemes must be used for the data transfer in wireless sensor networks. Thus focusing on antenna techniques to achieve Energy Efficiency in the Wireless sensor networks. In this project, we analyze the best transmission strategy to minimize the total energy consumption required to send a given number of bits. The total energy consumption includes both the transmission energy and the circuit energy consumption. We first consider multi-input–multi-output (MIMO) systems based on Alamouti diversity schemes, which have good spectral efficiency but also more circuitry that consumes energy. We then extend our energy-efficiency analysis of MIMO systems to individual single-antenna nodes that cooperate to form multiple-antenna transmitters or receivers. By transmitting and/or receiving information jointly, we show that tremendous energy saving is possible for transmission distances larger than a given threshold, even when we take into account the local energy cost necessary for joint information transmission and reception. We also show that over some distance ranges, cooperative MIMO transmission and reception can simultaneously achieve energy saving.

Signature of Student

Signature of Supervisor

Name

Name

Date

Date

LIST OF FIGURES

Fig -1 WSN.....	2
Fig-2 Different Antenna Configuration in Date-Time System.....	7
Fig – 3 Transmitter Circuit Blocks (ANALOG).....	14
Fig – 4 Receiver Circuit Blocks (ANALOG).....	14
Fig – 5 A 2 Transmit 1 Receive Alamouti STBC	17
Fig – 6 A 2 Transmit 2 Receive Alamouti STBC	19
Fig – 7 Total energy consumption (bound) per bit.....	23
over d, MISO versus SISO	
Fig – 8 Total energy consumption per bit over.....	24
d, MISO versus SISO	
Fig – 9 Total energy consumption per bit over.....	25
d, MIMO versus SISO	
Fig – 10 Total energy consumption over d,	26
MISO vs Traditional approach	
Fig – 11 Total energy consumption over d,.....	27
MIMO vs Traditional approach	
Fig – 12 Total energy consumption over d,.....	28
SIMO vs Traditional approach	

LIST OF ABBREVIATIONS

- ❖ **WSN** :- Wireless Sensor Networks
- ❖ **AWGN** :- Additive White Gaussian Noise
- ❖ **SNR** :- Signal to Noise ratio
- ❖ **MIMO** :- Multiple-input Multiple-output
- ❖ **SP** :- Spatial Multiplexing
- ❖ **SISO** :- Single-input Single-output
- ❖ **MISO** :- Multiple-input Single-output
- ❖ **SIMO** :- Single-input Multiple-output

CHAPTER - 1
INTRODUCTION TO WIRELESS SENSOR
NETWORK

1.1 INTRODUCTION

The Wireless Sensor Networks have emerged as a technology that are being quickly adopted due to their flexibility and used in a variety of environments. A Wireless Sensor Network is composed of a large number of sensor nodes that are densely deployed either inside the phenomenon or very close to it or we can say A wireless sensor network (WSN) consists of spatially distributed autonomous sensors to monitor physical or environmental conditions, such as temperature, sound, pressure, etc. and to cooperatively pass their data through the network to a main location. The more modern networks are bi-directional, also enabling control of sensor activity. The development of wireless sensor networks was motivated by military applications such as battlefield surveillance; today such networks are used in many industrial and consumer applications, such as industrial process monitoring and control, machine health monitoring, and so on. The position of sensor nodes can be predetermined to guarantee a uniformly sensing of a defined area or they can be randomly deployed in inaccessible terrains or in particular types of application as in disaster relief operations.

MIMO technology takes advantage of a radio-wave phenomenon called multipath where transmitted information bounces off walls, ceilings, and other objects, reaching the receiving antenna multiple times via different angles and at slightly different times. Multipath is a natural occurrence for all radio sources. Radio signals bounce off objects and move at different speeds towards the receiver. In the past multipath caused interference and slowed down wireless signals. MIMO takes advantage of multipath to combine the information from multiple signals improving both speed and data integrity.

A Typical WSN Scenario:

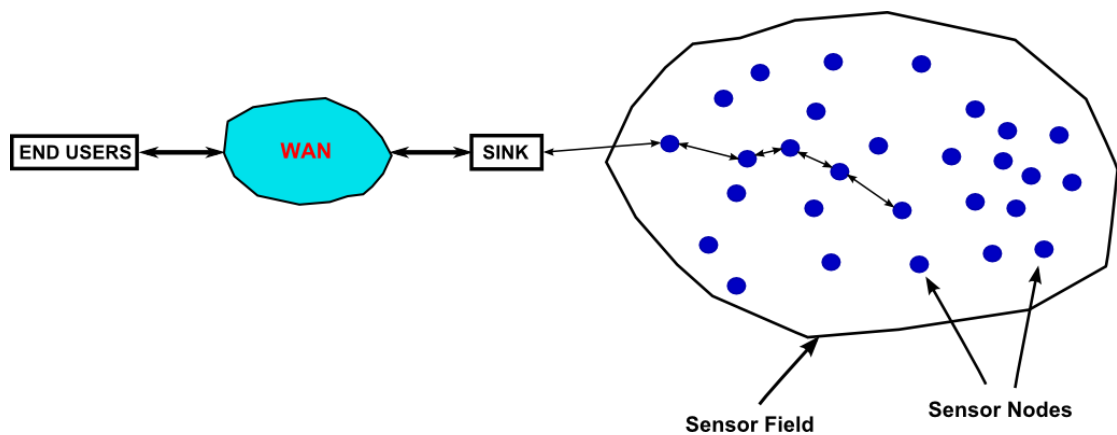

Fig -1 WSN

The WSN is built of "nodes" – from a few to several hundreds or even thousands, where each node is connected to one (or sometimes several) sensors. Each such sensor network node has typically several parts: a radio transceiver with an internal antenna or connection to an external antenna, a microcontroller, an electronic circuit for interfacing with the sensors and an energy source, usually a battery or an embedded form of energy harvesting. A sensor node might vary in size. Size and cost constraints on sensor nodes result in corresponding constraints on resources such as energy, memory, computational speed and communications bandwidth. The topology of the WSNs can vary from a simple star network to an advanced multi-hop wireless mesh network. The propagation technique between the hops of the network can be routing or flooding.

Energy is the scarcest resource of WSN nodes, and it determines the lifetime of WSNs. WSNs are meant to be deployed in large numbers in various environments, including remote and hostile regions, where ad hoc communications are a key component. For this reason, algorithms and protocols need to address the following issues:

- Lifetime maximization
- Robustness and fault tolerance
- Self-configuration

Lifetime maximization: Energy/Power Consumption of the sensing device should be minimized and sensor nodes should be energy efficient since their limited energy resource determines their lifetime. To conserve power the node should shut off the radio power supply when not in use.

The main characteristics of a WSN include:

- Power consumption constrains for nodes using batteries or energy harvesting
- Ability to cope with node failures
- Mobility of nodes
- Communication failures
- Heterogeneity of nodes
- Scalability to large scale of deployment
- Ability to withstand harsh environmental conditions
- Ease of use

Sensor nodes can be imagined as small computers, extremely basic in terms of their interfaces and their components. They usually consist of a processing unit with limited computational power and limited memory, sensors or MEMS (including specific conditioning circuitry), a communication device (usually radio transceivers), and a power source usually in the form of a battery.

The base stations are one or more components of the WSN with much more computational, energy and communication resources. They act as a gateway between sensor nodes and the end user as they typically forward data from the WSN on to a server. Other special components in routing based networks are routers, designed to compute, calculate and distribute the routing tables.

1.2 APPLICATIONS

Area monitoring:

Area monitoring is a common application of WSNs. In area monitoring, the WSN is deployed over a region where some phenomenon is to be monitored. A military example is the use of sensors detect enemy intrusion; a civilian example is the geofencing of gas or oil pipelines.

Air pollution monitoring:

Wireless sensor networks have been deployed in several cities (Stockholm, London and Brisbane) to monitor the concentration of dangerous gases for citizens. These can take advantage of the ad hoc wireless links rather than wired installations, which also make them more mobile for testing readings in different areas.

Forest fire detection:

A network of Sensor Nodes can be installed in a forest to detect when a fire has started. The nodes can be equipped with sensors to measure temperature, humidity and gases which are produced by fire in the trees or vegetation. The early detection is crucial for a successful action to extinguish it

Landslide detection:

A landslide detection system makes use of a wireless sensor network to detect the slight movements of soil and changes in various parameters that may occur before or during a landslide. Through the data gathered it may be possible to know the occurrence of landslides long before it actually happens.

Health care monitoring:

The medical applications can be of two types: wearable and implanted. Wearable devices are used on the body surface of a human or just at close proximity of the user. The implantable medical devices are those that are inserted inside human body. There are many other applications too e.g. body position measurement and location of the person, overall monitoring of ill patients in hospitals and at homes.

Water quality monitoring:

Water quality monitoring involves analyzing water properties in dams, rivers, lakes & oceans, as well as underground water reserves. The use of many wireless distributed

sensors enables the creation of a more accurate map of the water status, and allows the permanent deployment of monitoring stations in locations of difficult access, without the need of manual data retrieval.

Natural disaster prevention:

Wireless sensor networks can effectively act to prevent the consequences of natural disasters, like floods. Wireless nodes have successfully been deployed in rivers where changes of the water levels have to be monitored in real time.

CHAPTER – 2

The MIMO Wireless Channel

2.1 INTRODUCTION

In radio, multiple input and multiple output, or MIMO , is the use of multiple antennas at both the transmitter and receiver to improve communication performance .It is one of several forms of smart antenna technology. Note that the terms input and output refer to the radio channel carrying the signal, not to the devices having antennas.

MIMO technology has attracted attention in wireless communication, because it offers significant increase in data throughput and link range without additional bandwidth or increased transmit power. It achieves this goal by spreading the same total transmit power over the antennas to achieve an array gain that improves the spectral efficiency (more bits per second per hertz of bandwidth) or to achieve a diversity gain that improves the link reliability (reduced fading) . Because of these properties ,MIMO is an important part of modern wireless communication standards such as IEEE 802.11m (Wi-Fi), 4G,3GPP Long term Evolution , WiMAX and HSPA+.

2.2 PRELIMINARIES

2.2.1 Multi-Antenna System

The figure below displays different antenna configuration used in defining space-Time systems. SISO (Single Input Single Output) is the well known wireless configuration . Single-Input Multiple-output (SIMO) uses a single transmitting antenna and multiple (MR) receive antennas. Multiple- Input single-output (MISO) has multiple (MR) receive antenna and finally, MIMO-multiuser (MIMO-MU) which refers to a configuration that comprises a basic station with multiple transmit/receive antennas interacting with multiple users, each with one or more antennas.

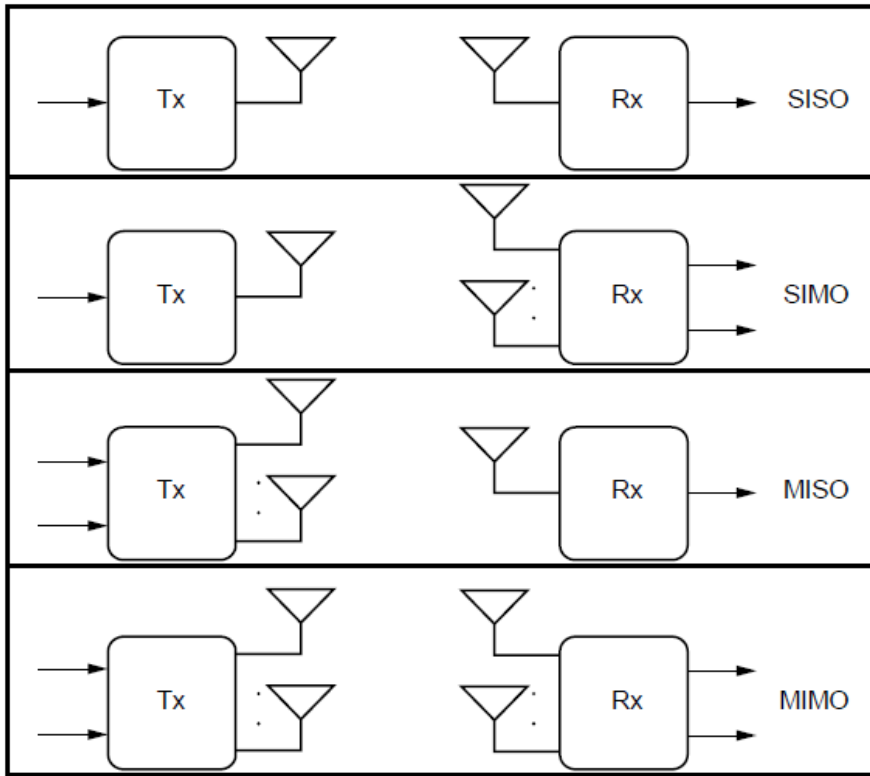

Fig-2 Different Antenna Configuration in Date-Time System

2.2.2 Array gain

Array gain is the average increase in the signal to noise ratio (SNR) as the receiver that arises from the coherent combining effect of multiple antennas at the receiver or transmitter or both. If the channel is known to the multiple antennas transmitters, the transmitter will weigh the transmission with weights depending on the channel. If the channel is known to the multiple antennas transmitters, the transmitter will weigh the transmission with weights, depending on the channel.

2.2.3 Diversity gain

Multipath fading is a significant problem in communications. In a fading channel, signals experience fades (i-e. they fluctuate in their strength). When the signal power drops significantly, the channel is said to be in a fade. This gives rise to high bit error rates (BER). We resort to diversity to combat fading. This involves providing replicas of the transmitted signal over time, frequency or space. There are three types of diversity schemes in wireless communications.

- **Frequency Diversity** :This type of diversity provides replicas of the original signal in the frequency domain .This is applicable in those cases where the coherence bandwidth of the channel is small compared with the bandwidth of the signal.
- **Spatial Diversity**:This is also known as Antenna Diversity and is an effective way of combating multipath fading. In this case , replicas of the same transmitted signal are provided across the antennas of the receiver. This is applicable in those spaces where the antenna spacing is larger than the coherent distance to ensure independent fades across different antennas .In the category of spatial diversity there are two more types of diversity that needs to be illustrated .These are :
 - **Polarization Diversity**:In this type of diversity horizontal and vertical polarization signals are transmitted by two different polarized antennas and received correspondingly by two different polarized antennas at the receiver.Different polarization ensure that there is no correlation between the data streams ,without having to worry about coherent distance of separation between the antennas

2.2.4 Spatial Multiplexing

Spatial multiplexing offers a linear (in the number of transmit- receive antenna pair or M_R, M_T) increase in the transmission rate (or capacity) for the same bandwidth and with no additional power expenditure. It is only possible in MIMO channels

The bit stream is split into two half-rate bit streams, modulated and transmitted simultaneously from both the antennas. The receiver, having complete knowledge of the channel , receives these individual bit streams and combine them so as to recover the original bit stream. Since the receiver has knowledge of the channel it provides receive diversity, but the system has no transmit diversity since the bit streams are completely different from each other in that they carry totally different data. Thus spatial multiplexing increase the transmission rates proportionally with the number of transmit- receive antenna pair.

2.2.5 Additional Terms

- Automatic request for report (ARQ):- This is an error control mechanism in which the received packets that cannot be corrected are retransmitted. This is type of temporal diversity.
- Forward error correction (FEC):- This is a technique that inserts redundant bit during transmission to help detect and correct bit errors during reception.
- Coding Gain:- The improvement in SNR at receiver because of FEC is called coding gain.
- Interleaving: - A form of data scrambling that spreads burst of bit errors evenly over the received data allowing efficient forward error correction.
- Multiplexing gain :- Capacity gain at no additional or bandwidth consumption obtained through the antennas at both sides of wireless link.

2.3 FORMS OF MIMO

2.3.1 Multiple Antenna types

Multi antenna MIMO (for single user MIMO) technology has been developed and implemented in some standards e.g 802.11m products.

- **SISO/SIMO/MISO are degenerate case of MIMO**
 - Multiple –input and single –output (MISo) is a degenerate case when the reciever has a single antenna.
 - Single-input and Multiple –output (SIMO) is a degenerate case when the transmitter has a single antenna.
 - Single-input single-output (SISO) is a radio system where neither the transmitter nor reciever has multiple antennas.
- **Principle single-user MIMO techniques**

- Bell Laboratories Layered Space –Time (BLAST), Gerard J. Foschin (1996)
- Per Antenna Rate Control (PARC), Varanasi, Guess (1998)
- Selective per Antenna Rate Control (SPARC), Ericsson (2004)

2.3.2 Multiple user types

Recently, results of research on multi-user MIMO technology have been emerging. While full multi user MIMO (or Network MIMO) can have a higher potential, practically, the research on (partial) multi-user MIMO (or multi-user and multi-antenna MIMO) technology is more active

- **Multi-user MIMO (MU-MIMO)**

- In recent 3GPP and WiMAX standards, MU-MIMO is being treated as one of the candidate technologies adoptable in the specification by a number of companies, including Samsung , Qualcomm, Ericsson, Huawei, Philips. For these and other firms active in the mobile hardware market , MU-MIMO is more feasible for low complexity cell phones with a small number of reception antennas, whereas SU-MIMO's higher per-user throughput is better suited to more complex user devices with more antennas.
- PU²RC allows the network to allocate each antenna to a different user instead of allocating only a single user as in single-user MIMO scheduling.

The network can transmit user data through a code-book based spatial beam or a virtual antenna. Efficient user scheduling ,such as pairing spatially distinguishable users with code-book based spatial beams, is additionally discussed for the simplification of wireless networks in terms of additional wireless resource requirements and complex protocol modification. Recently, PU²RC is included in the system description

documentation (SDD) of IEEE 802.11m (WiMAX evolution meet the ITU-R's IMT- Advance requirements)

- Enhanced multiuser MIMO :-
 - 1.) Employs advanced decoding techniques
 - 2.) Employs advanced pre-coding techniques
- SDMA represents either space –division multiple access or super division multiple access where super emphasis that orthogonal division such as frequency and time division is not used but non-orthogonal approaches such as superposition coding are used.

- **Cooperative MIMO (CO-MIMO)**
- Uses distributed antennas which belong to other users.
- **MIMO Routing**
 - Routing a cluster by a cluster in each hop, where the number of nodes in each cluster is larger or equal to one. MIMO routing is different from conventional (SISO) routing since conventional routing protocols route a node by a node in each loop.

2.4 Space-Time Block Code using Virtual Array Antenna

Since nodes in a wireless sensor network may not be able to accommodate multiple antennas, the implementation of MIMO-based communication in a wireless sensor network requires sensor cooperation. A common scenario in distributed wireless sensor networks is that of a set of low-end data collection sensors connected over a wireless link with a high-end **data gathering node** (DGN) that acts as a lead sensor. The set of low-end data collection sensors is connected over a wireless link with a high-end data gathering node (DGN) that act as a lead-sensor. The data collection sensors are typically subjected to strict energy constraints while data gathering node is not.

In this wireless sensor network model, cooperative MIMO based communication can be achieved as follows: Suppose a set of data collection nodes has data to be sent to the data

gathering node. Each of these sensors which are assumed to be close to each other broadcasts their data to the others in the set using a time-division multiple-access scheme. This step is known as the local communications at the transmitter side . At the end of this step each node has data from all other sensor nodes enabling space-time block coding as if each node were a distinct transmit antenna element in a centralized antenna

array. Once the space-time coding is done, each node transmits the encoded symbols corresponding to a specific transmit antenna element over the wireless channel to the DGN. This step is known as the long-haul communication. The DGN is assumed not to have any energy constraint attached to it, or has relatively much longer battery life, and can be of larger physical dimensions to accommodate multiple receiver antennas. This allows realization of true MIMO capability with only the transmitter side local communications.

It should be noted that the above model is one of the simplest of this type. In a practical system there may be a number of data gathering nodes. In such a system there are different ways to realize MIMO-based energy-efficient communication. Also, all data collection nodes need not cooperate as one transmit antenna system. In most distributed wireless sensor networks there might be a large number of data collection sensors scattered over a large area, making it more convenient (and efficient) to have a number of virtual transmit antenna arrays.

CHAPTER – 3

SYSTEM MODEL AND THE SIMULATION MODEL

3.1 PROPOSED SYSTEM MODEL

The model considered is a general communication link connecting two wireless nodes, which can be multiple-input-multiple-output (MIMO), multiple-input-single-output (MISO), single-input-multiple-output (SIMO), or single-input-single-output (SISO). In order to consider the total energy consumption, all signal processing blocks at the transmitter and the receiver need to be included in the model. However, in order to keep the model from being over-complicated at this stage, baseband signal processing blocks (e.g., source coding, pulse-shaping, and digital modulation) are intentionally omitted. Also the system is believed to be Uncoded.[4]

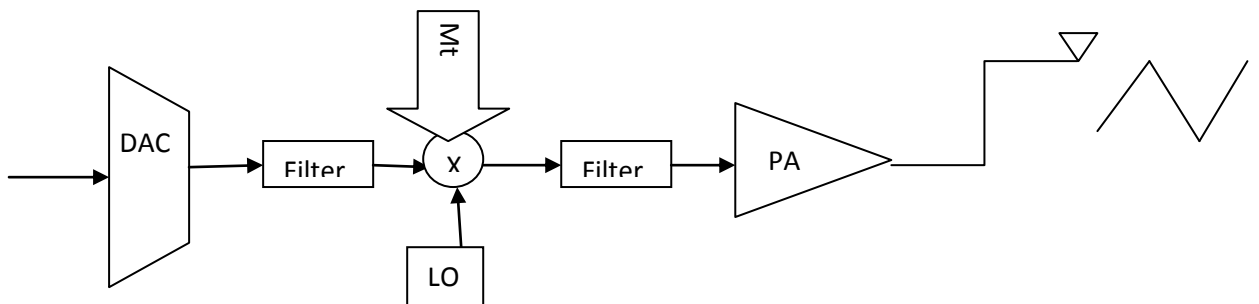

Fig – 3 Transmitter Circuit Blocks (ANALOG)

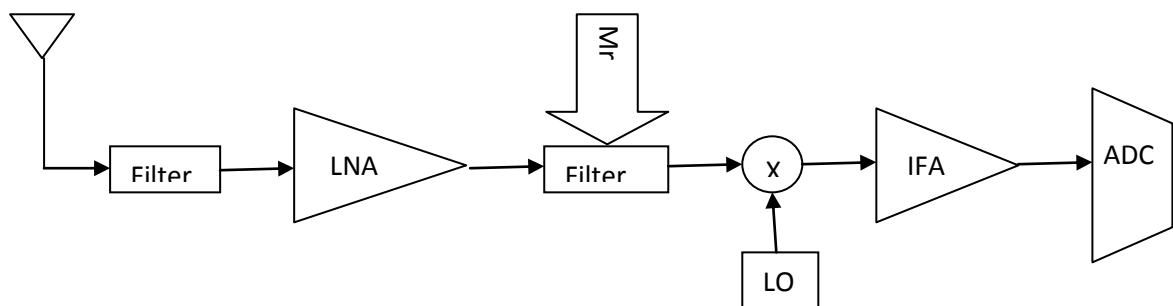

Fig – 4 Receiver Circuit Blocks (ANALOG)

Where M_t and M_r are the numbers of transmitter and receiver antennas, respectively, and we assume that the frequency synthesizer (LO) is shared among all the antenna paths. For the SISO case, $M_t = M_r = 1$

The total average power consumption along the signal path can be divided into two main components P_{PA} the power consumption of all the power amplifiers and P_C and the power consumption of all other circuit blocks. The first term P_{PA} is dependent on the transmit power P_{out} , which can be calculated according to the link budget relationship. Specifically, when the channel only experiences a square-law path loss, which is as follows:

$$P_{out} = \overline{E_b} R_b \times \frac{(4\pi d)^2}{G_t G_r 1/f^2} M_l N_f$$

Where $\overline{E_b}$ is the required energy per bit at the receiver for a given BER requirement, R_b is the bit rate, d is the transmission distance,

G_t is the transmitter antenna gain,

G_r is the receiver antenna gain,

M_l is the link margin compensating the hardware process variations and other additive background noise or interference, and

N_f is the receiver noise figure defined as with $N_f = (N_r/N_0)$ with $N_0 = -171$ dBm/Hz the single-sided thermal noise power spectral density (PSD) at room temperature and N_r is the PSD of the total effective noise at the receiver input

The power consumption of the power amplifiers can be approximated as [4]

$$P_{PA} = (1 + \alpha) P_{out}$$

The second term in the total power consumption is given by

$$P_C = M_t (P_{DAC} + P_{mix} + P_{filt}) + 2P_{syn} + M_r (P_{LNA} + P_{mix} + P_{filt} + P_{IFA} + P_{ADC})$$

P_{DAC} , P_{mix} , P_{filt} , P_{syn} , P_{LNA} , P_{IFA} and P_{ADC} are the power consumption values for the DAC, the mixer, the filter, the synthesizer, the low noise amplifier, the intermediate frequency amplifier, the analog to digital convertor respectively. The total energy consumption per bit for a fixed rate system can be obtained as

$$E_{bt}=(P_{PA} + P_c)/R_b$$

For simplicity, the Alamouti Schemes [1] are used to achieve diversity in the MIMO System. The Alamouti code with two transmit antennas, uses two different symbols, x_1 and x_2 that are transmitted simultaneously during the first symbol period from antennas 1 and 2 followed by the complex conjugate of the same during the next symbol period. The Alamouti codes can also be extended to more than two antennas. We also consider the channel to be Rayleigh-fading channel. In Rayleigh-fading channels MIMO systems based on Alamouti schemes can achieve lower

average probability of error than SISO systems under the same transmit energy budget due to the diversity gain and possible array gain (when the number of antennas at receiver side is greater than 1). In other words, under the same BER and throughput requirement, MIMO systems require less transmission energy than SISO systems.

3.1.1 Fixed Rate System

Considering a Fixed Rate System with BPSK modulation a flat Rayleigh-fading channel, i.e., the channel gain between each transmitter antenna and each receiver antenna is a scalar is considered. Therefore, the fading factors of the MIMO channel can be represented as a scalar matrix. In addition, the path loss is modeled as a power falloff proportional to the distance squared. In other words, on top of the square-law path loss, the signal is further attenuated by a scalar fading matrix , in which each entry is a zero-mean circulant symmetric complex Gaussian (ZMCSCG) random variable with unit variance.[9][12]and also mentioned in [4][6]. The fading is assumed constant during the transmission of each Alamouti codeword. In the following work we focus on MISO and MIMO systems that use Alamouti schemes with BPSK modulation and compare their energy efficiency with that of a reference SISO system.

- FOR ALAMOUTI 2X1:

For 2X1 MISO Alamouti scheme where $\mathbf{H} = [h_1, h_2]$ The reference SISO system is treated as a special case of MISO systems with $\mathbf{H} = [h_1]$. The instantaneous received SNR is given by [1]

$$\gamma = \frac{\|\mathbf{H}\|^2 E_b}{N_0 M_t}$$

$M_t=1,2$ (it is the number of antennas at transmitter side for MISO it will be 2 and for SISO it will be 1)

And M_t in denominator comes from the fact that the transmit power is equally split among transmitter antennas. The average BER is given by

$$\bar{P}_b = \epsilon_h \{Q\sqrt{2\gamma_b}\}$$

According to the Chernoff bound (in high SNR Regime)[1][7]

$$\bar{P}_b \leq \left(\frac{\bar{E}_b}{M_t N_0}\right)^{-M_t}$$

The upper bound for the required energy per bit

$$\bar{E}_b \leq \frac{M_t N_0}{\bar{P}_b^{(-\frac{1}{M_t})}}$$

By approximating the bound as an equality, we can calculate the total energy consumption (which is actually an upper bound) per bit for both the MISO system and the reference SISO system. Thus the equation becomes

$$E_{bt} = (1 + \alpha) \frac{M_t N_0}{\bar{P}_b^{(-\frac{1}{M_t})}} \times \frac{(4\pi d)^2}{G_t G_r 1/f^2} M_t N_f + (P_c/R_b)$$

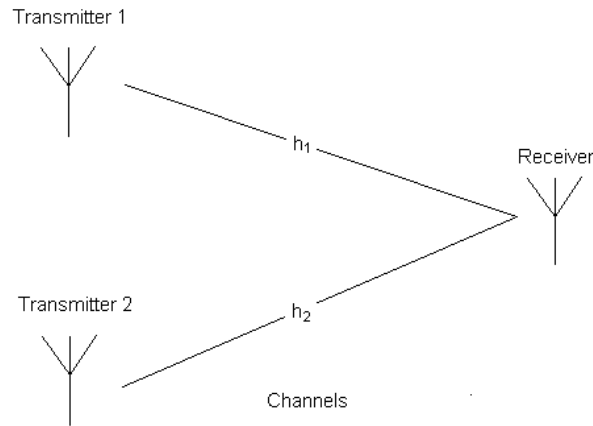

Fig – 5 A 2 Transmit 1 Receive Alamouti STBC

	Transmitter 1	Transmitter 2
Time t	x_1	x_2
Time t + T	$-x_2^*$	x_1^*

where x_1, x_2 are the modulated symbols.

The received vectors are

$$y_1 = h_1(x_1) + h_2(x_2) + n_1 \text{ (first time slot)}$$

$$y_2 = h_1(-x_2^*) + h_2(x_1^*) + n_2 \text{ (second time slot)}$$

- FOR ALAMOUTI 2X2:

We now consider a 2X2 MIMO system based on the Alamouti code where the channel matrix is given by

$$\mathbf{H} = \begin{bmatrix} h_{11} & h_{21} \\ h_{12} & h_{22} \end{bmatrix}$$

In the first time slot, the received signal on the first receive antenna is,

$$y_1 = h_{1,1}x_1 + h_{1,2}x_2 + n_1 = [h_{1,1} \ h_{1,2}] \begin{bmatrix} x_1 \\ x_2 \end{bmatrix} + n_1$$

The received signal on the second receive antenna is

$$y_2 = h_{2,1}x_1 + h_{2,2}x_2 + n_2 = [h_{2,1} \ h_{2,2}] \begin{bmatrix} x_1 \\ x_2 \end{bmatrix} + n_2$$

where

y_1, y_2 are the received symbol on the first and second antenna respectively,

$h_{1,1}$ is the channel from 1st transmit antenna to 1st receive antenna,

$h_{1,2}$ is the channel from 2nd transmit antenna to 1st receive antenna,

$h_{2,1}$ is the channel from 1st transmit antenna to 2nd receive antenna,

$h_{2,2}$ is the channel from 2nd transmit antenna to 2nd receive antenna,

x_1, x_2 are the transmitted symbols and

n_1, n_2 is the noise on 1st, 2nd receive antennas.

We assume that the receiver knows $h_{1,1}$, $h_{1,2}$, $h_{2,1}$ and $h_{2,2}$. The receiver also knows y_1 and y_2 . The unknowns are x_1 and x_2 .

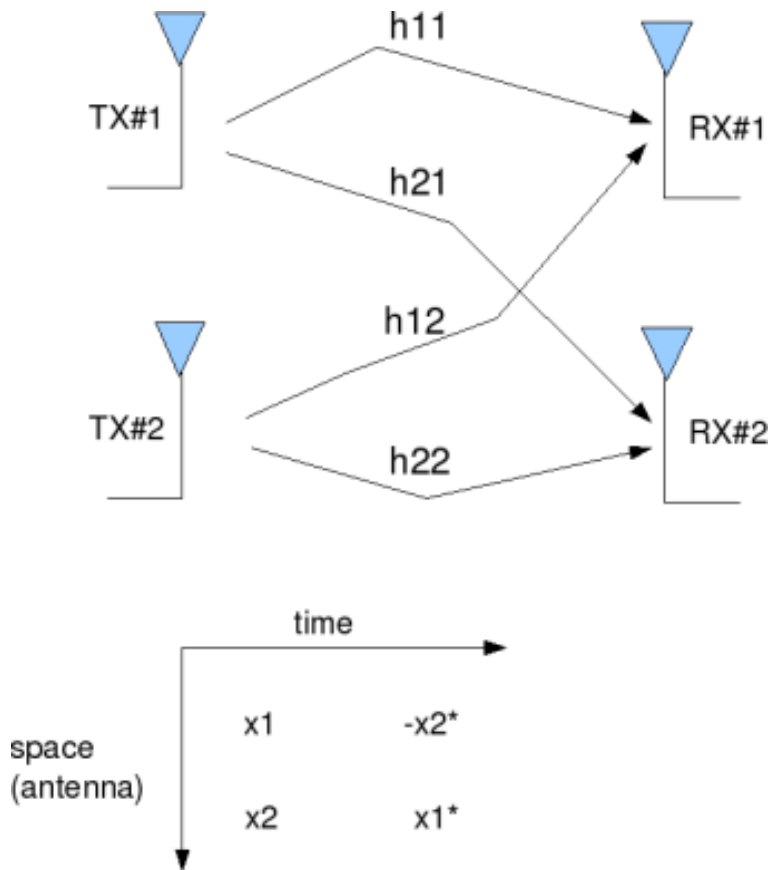

Fig – 6 A 2 Transmit 2 Receive Alamouti STBC

3.1.2 With Multinode Cooperation

Now considering MIMO with Multi-node cooperation, For wireless sensor networks, maximizing the network lifetime is the main concern. Since sensor networks are mainly designed to cooperate on some joint task where per-node fairness is not emphasized, the design intention is to minimize the total energy consumption in the network instead of minimizing energy consumption of individual nodes. In this a strategy to minimize the total energy consumption of multiple nodes from a network perspective is considered.[1]

In a typical sensor network, information collected by multiple local sensors need to be transmitted to a remote central processor. If the remote processor is far away, the

information will first be transmitted to a relay node, then multihop-based routing will be used to forward the data to its final destination.

If cooperative transmission among multiple nodes is allowed, the nodes can be treated as multiple antennas to the destination node such that an equivalent MISO system can be constructed. By using this equivalent MISO system, the requirement on transmission energy for the long-haul transmission can be reduced. However, in order to make the cooperative transmission possible, local data exchange is necessary before the long-haul transmission. The local information flow costs energy, which should be less than the energy saved by using the MISO structure. Another trade-off is the transmission delay since the MISO approach has different delay characteristics than non-cooperative approaches. Here the comparison of the performance between the MISO strategy and the non-cooperative approach to show which one is more energy-efficient.

Cooperation on the transmitting side is not the only method we can explore. On the receiving side there may also be multiple nodes around the destination node such that cooperative reception is possible. Therefore, an equivalent SIMO or MIMO system can be constructed. Similarly, local energy consumption is necessary due to the data aggregation among receiving nodes

In order to compare the performance between the non cooperative approach and the MIMO approach, some assumptions need to be made. We assume that there are M_t Transmitting nodes and each has N_i bits to transmit, where $i=1,2,3,\dots, M_t$

For the non-cooperative approach, we assume that each transmitting node uses a different time slot to transmit the information to the remote node with uncoded MQAM. For the MIMO approach, the M_t nodes on the transmitting side will cooperate. Each node first broadcasts its information to all the other local nodes using different time slots. After each node receives all the information bits from other nodes, they encode the transmission sequence according to the Alamouti diversity codes. Since each node has a pre assigned index, they will transmit the sequence which the i th antenna should transmit in an Alamouti MIMO system. On the receiving side, there are M_r nodes (including one destination node and M_r-1 assisting nodes) joining the cooperative reception. The M_r-1 assisting nodes first quantize each symbol they receive into n_r bits, then transmit all the bits using uncoded MQAM to the

destination node to do the joint detection. The total energy consumption in each node only includes the transmission energy and the analog circuit energy consumption. For local transmissions, we assume a k th-power path loss ($\text{loss} \propto \frac{1}{d_k}$) with additive white Gaussian noise (AWGN). For long-haul transmissions, we assume a Rayleigh-fading channel with square-law path loss. Within the local cluster (for both Tx side and Rx side), if the maximum separation is d_m m, we assume each node will optimize their constellation size according to this worst-case distance. Since usually the long-haul distance between the remote node and the local cluster is much larger than d_m m we assume the long-haul transmission distance, denoted as d , is the same for each transmitting node.[5]

The energy cost per bit for local information flow on the Tx side, denoted as E_i^t , $i=1, \dots, M_t$ and the energy cost per bit for local information flow on the Rx side, denoted as E_j^r , $j=1, \dots, M_r-1$ can be calculated according to the result we obtained for SISO communication links in AWGN channels. However for calculating E_i^t Since there are always $M_t - 1$ Receivers listening during the local transmission, the total circuit energy consumption on the receiver side should be the total energy consumption of $M_t - 1$ sets of circuits. The energy cost per bit for the MIMO long-haul transmission, denoted as E_b^r . For the SISO long-haul transmission used by the noncooperative approach, the energy per bit denoted as E_i^0 can be calculated as a special case of MIMO systems where we set $M_t = M_r = 1$

As a result, the total energy consumption E_{tra} for the noncooperative approach is given by

$$E_{tra} = \sum_{i=1}^{M_t} N_i E_i^0$$

While the total energy consumption for the cooperative MIMO approach is given by E_{MIMO}

$$E_{MIMO} = \sum_{i=1}^{M_t} N_i E_i^t + E_b^r \sum_{i=1}^{M_t} N_i + \sum_{j=1}^{M_r-1} E_j^r n_r N_s$$

Where $N_s = \sum_{i=1}^{M_t} N_i / b_m$ is the total number of b_m the constellation size used in the Alamouti code.

The total delay includes both the local transmission delay and the long-haul transmission delay. Accordingly

$$T_{MIMO} = T_s (\sum_{i=1}^{M_t} N_i / b_i^t + \sum_{i=1}^{M_t} N_i / b_m + \sum_{i=1}^{M_r-1} N_s n_r / b_j^r)$$

Where, b_i^t and b_j^r are the constellation sizes used during the local transmission on the Tx side and the Rx side, respectively. The first and the third terms in the total delay are the local delay values contributed by the Tx side and the Rx side, respectively, and the second term is the delay caused by the long-haul MIMO transmission.

To give numerical examples, we assume that $d_m = 1$ m and $B=10$ kHz and $n_r = 10$ and all the transmitting nodes have the same number of bits to transmit, $N_i=20$ kb.

3.2 SCHEMATIC MODEL

- Generate random binary sequence of +1's and -1's.
- Group them into pair of two symbols and send two symbols in one time slot
- Multiply the symbols with the channel and then add white Gaussian noise.
- Equalize the received symbols .
- Take the symbol from the second spatial dimension, subtract from the received symbol
- Repeat for multiple values of $\frac{E_b}{N_0}$ and plot the simulation.

CHAPTER – 4

SIMULATION RESULTS

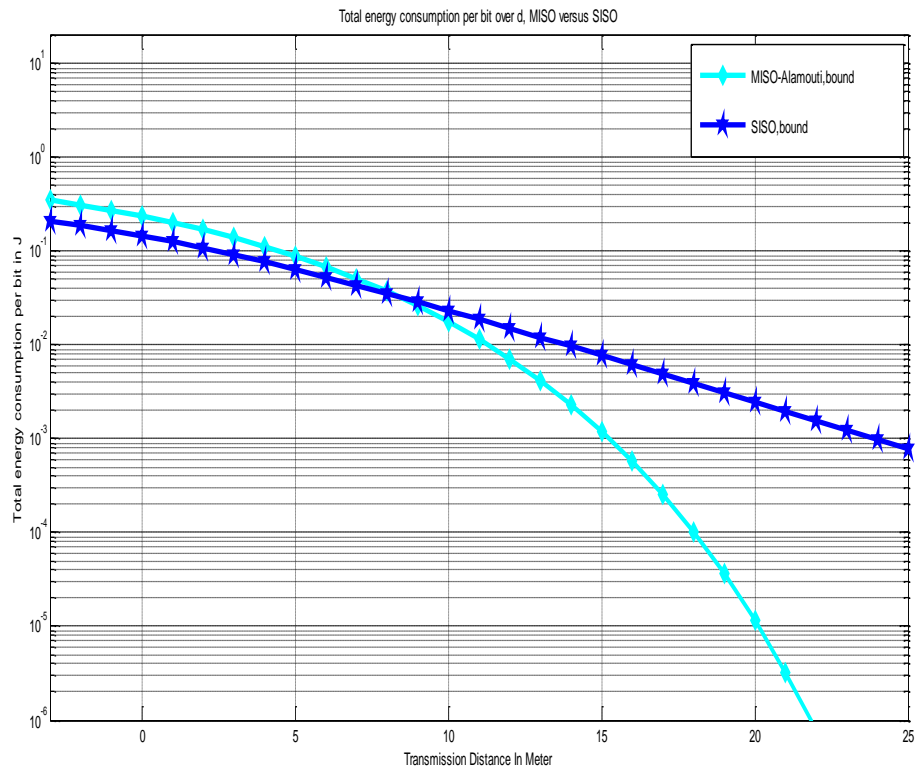

Fig – 7 Total energy consumption (bound) per bit over d, MISO versus SISO

The above results depicts the total energy consumption Vs transmission distance in meter for MISO Alamuti bound and SISO. The results show that above the 8 meter, per node energy consumption is drastically reduced in MISO system

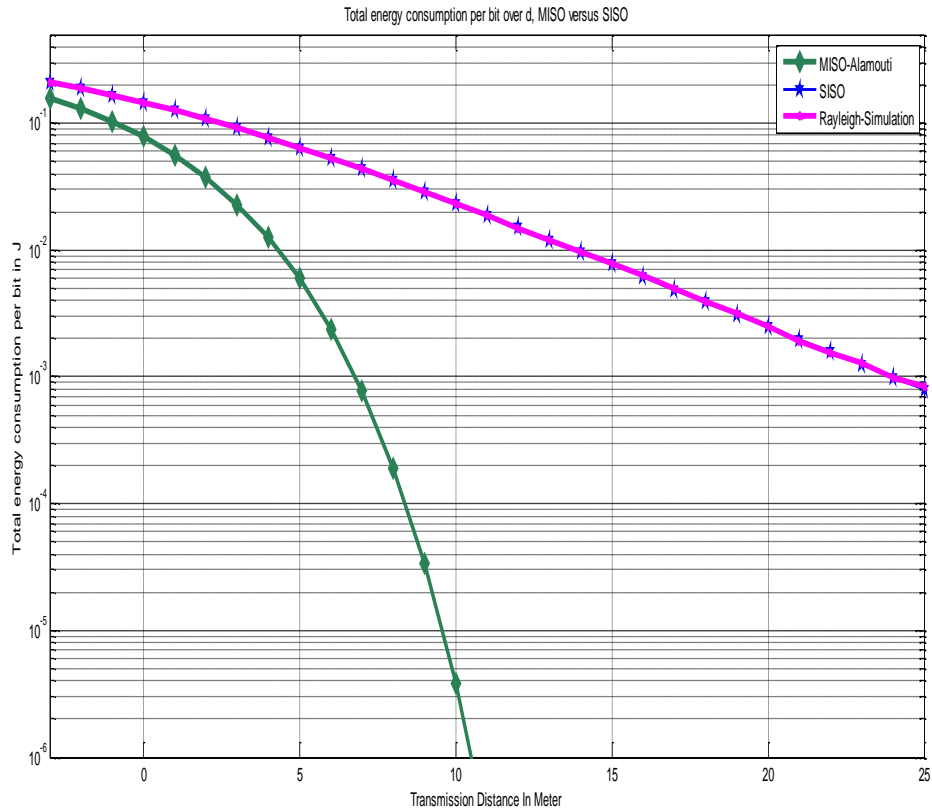

Fig – 8 Total energy consumption per bit over d, MISO versus SISO

The above results are comparison of three technique MISO-Alamouti SISO and Rayleigh Simulation, a flat Rayleigh-fading channel, the channel gain between each transmitter antenna and each receiver antenna is a scalar. Therefore, the fading factors of the MIMO channel can be represented as a scalar matrix. In addition, the path loss is modeled as a power falloff proportional to the distance squared, In other words, on top of the square-law path loss, the signal is further attenuated by a scalar fading matrix , in which each entry is a zero-mean circulant symmetric complex Gaussian (ZMCSCG) random variable with unit variance [1]. The fading is assumed constant during the transmission of each Alamouti codeword. The above results implicates that as the distance increases the per node energy in MISO system reduces significantly as compare to the other technique.

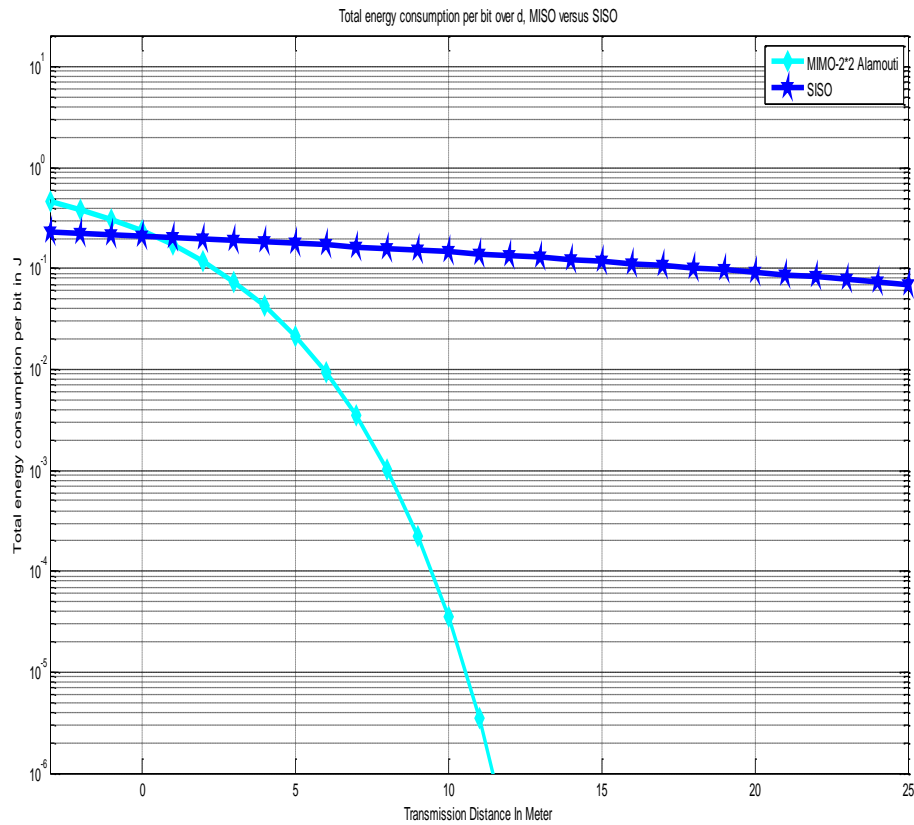

Fig – 9 Total energy consumption per bit over d, MIMO versus SISO

Last two results were the comparison of MISO with SISO technique the above result is the comparison of MIMO technique with SISO in the above result we have considered the two transmitting antenna and two receiving antenna and the results shows that the MIMO technique is better for long haul communication as compared to SISO technique.

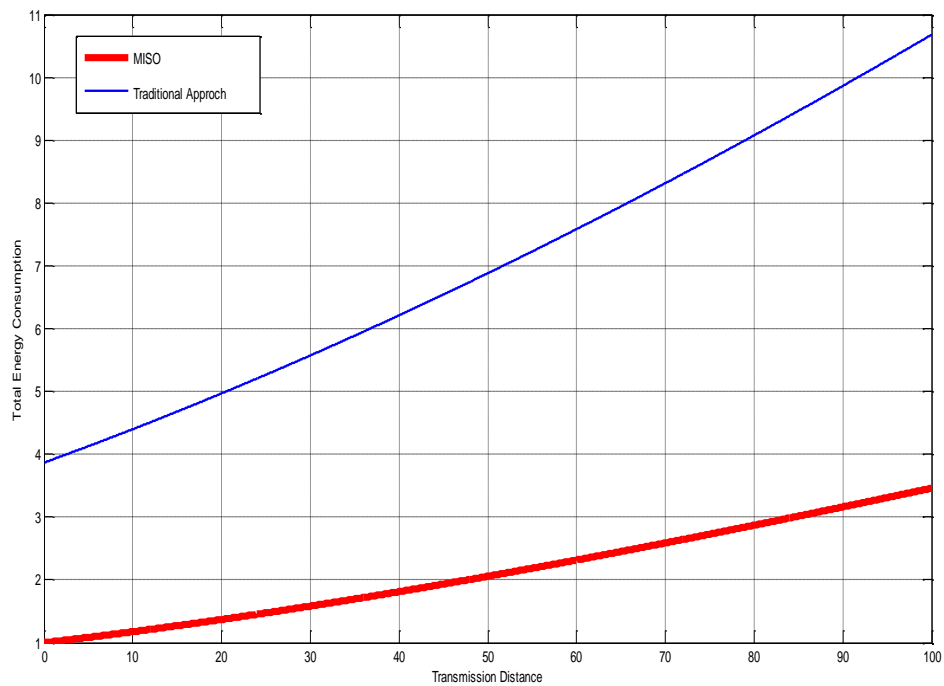

Fig – 10 Total energy consumption over d, MISO vs Traditional approach

The above graph is the total energy consumption of MISO and traditional approach. As the distance increases the total energy consumption in MISO is smaller than SISO technique. The total energy consumption of the MISO approach and the non-cooperative approach is plotted over the long-haul transmission distance. The MISO approach becomes more energy-efficient than the traditional approach about 50% energy savings is possible by using the MISO strategy and the savings is increased roughly in a linear fashion over .

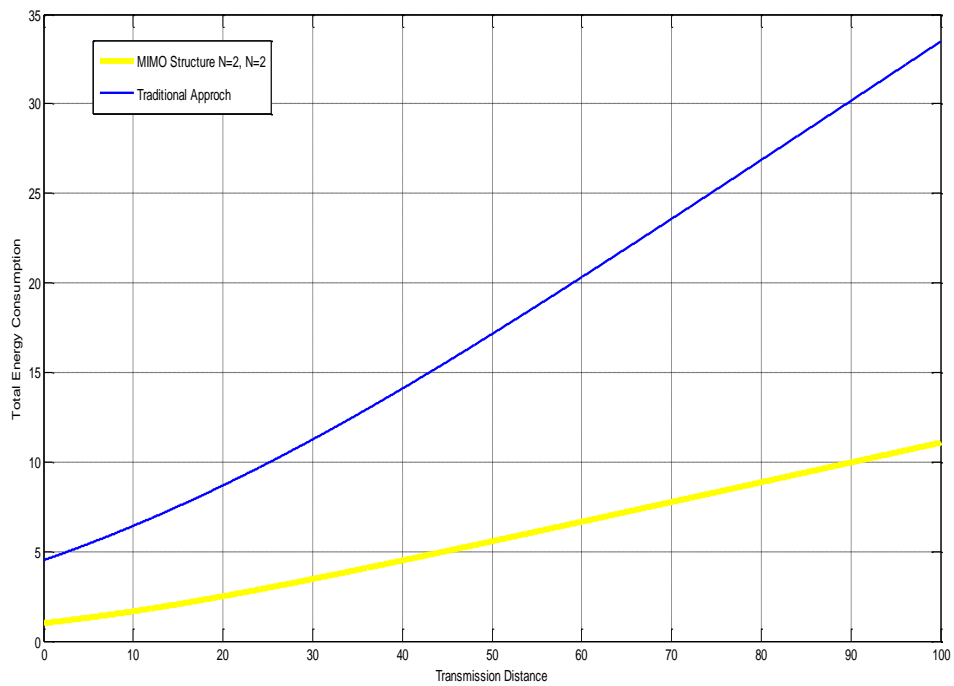

Fig – 11 Total energy consumption over d, MIMO vs Traditional approach

The above is the comparison of total energy consumption of MIMO and traditional approach. The graph indicates that for long haul communication MIMO technique is more energy efficient than traditional approach.

Since the MIMO structure involves more local energy consumption compared with the MISO or SIMO structure, the threshold distance above which MIMO becomes more energy-efficient is increased. However, since MIMO requires less transmission energy for the long-haul transmission, the total energy consumption will become smaller compared with MISO or SIMO when distance is large enough.

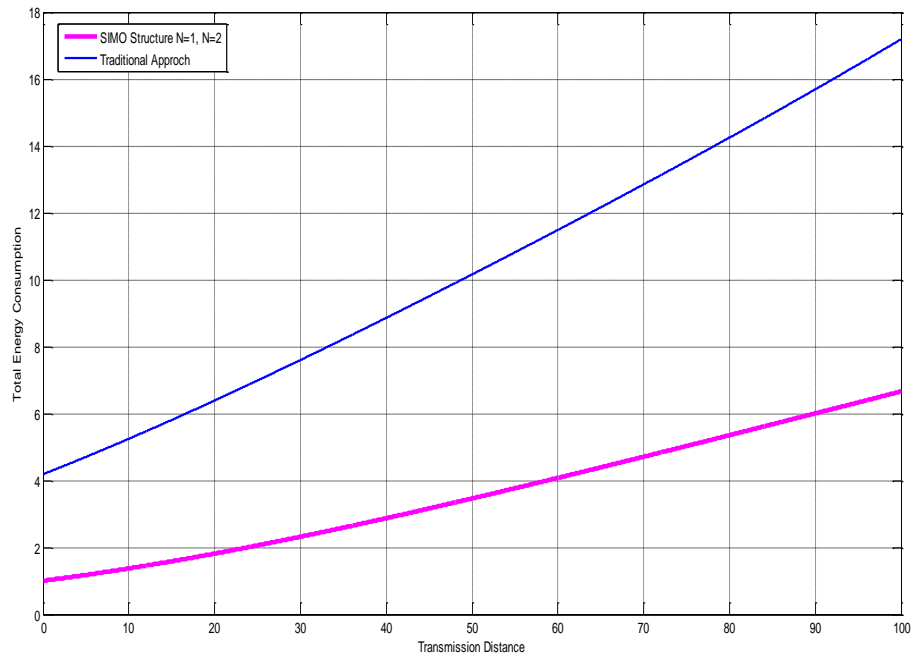

Fig – 12 Total energy consumption over d, SIMO vs Traditional approach

In this we allow cooperation only at the receiver end. The total energy consumption of the SIMO approach and the non-cooperative approach is drawn over different long-haul transmission distances.

CONCLUSION

In this project we have compared the energy efficiency of different antenna techniques like MIMO, MISO, SIMO and SISO in a fixed rate system with a flat Rayleigh-fading channel, the channel gain between each transmitter antenna and each receiver antenna is a scalar. Therefore, the fading factors of the MIMO channel can be represented as a scalar matrix. This was done by implementing Alamouti space time block codes , the Alamouti Schemes are used to achieve diversity in the MIMO System. The modulation technique used is binary phase shift keying or BPSK . As a result to our simulation we observed that the MIMO technique has shown superior results and therefore is a much more energy efficient even with extra circuitry power consumption.

While considering a cooperative communication system, sensor networks are mainly designed to cooperate on some joint task where per-node fairness is not emphasized, the intention is to minimize the total energy consumption in the network instead of minimizing energy consumption of individual nodes. The energy efficiency of cooperation among nodes for both information transmission and reception. By allowing cooperation, we can treat the equivalent system as a MIMO system. By applying the energy minimization result to this equivalent MIMO system, we observe that over certain distance ranges the total energy consumption can be reduced.

REFERENCES

- [1] A. Paulraj, R. Nabar, and D. Gore, *Introduction to Space-Time Wireless Communications*, Cambridge, U.K.: Cambridge Univ. Press, 2003. preprint.
- [2] C. Schurgers, O. Aberthorne, and M. B. Srivastava, "Modulation scaling for energy aware communication systems," in *Proc. Int. Symp. LowPower Electronics Design*, Aug. 2001, pp. 96–99.
- [3] R. Min and A. Chandrakasan, "A framework for energy-scalable communication in high-density wireless networks," in *Proc. Int. Symp. Low Power Electronics Design*, Aug. 2002, pp. 36–41.
- [4] S. Cui, A. J. Goldsmith, and A. Bahai, "Modulation optimization under energy constraints," in *Proc. ICC'03*, AK, May 2003, pp. 2805–2811. [Online]. Available: <http://wsl.stanford.edu/Publications.html>.
- [5] , "Energy-constrained modulation optimization for coded systems," in *Proc. GLOBECOM'03*, San Francisco, CA, Dec. 2003, pp. 372–376. [Online]. Available: <http://wsl.stanford.edu/Publications.html>.
- [6] , "Energy-constrained modulation optimization," *IEEE Trans. Wireless Commun.*, 2004. [Online]. Available: <http://wsl.stanford.edu/Publications.html>, submitted for publication.
- [7] J. G. Proakis, *Digital Communications*, 4th ed. New York: McGraw- Hill, 2000.
- [8] S. Alamouti, "A simple transmit diversity technique for wireless communications," *IEEE J. Select. Areas Commun.*, vol. 16, pp. 1451–1458, Oct. 1998.
- [9] T. H. Lee, *The Design of CMOS Radio-Frequency Integrated Circuits*, Cambridge, U.K.: Cambridge Univ. Press, 1998.
- [10] M. Steyaert, B. De Muer, P. Leroux, M. Borremans, and K. Mertens, "Low-voltage low-power CMOS-RF transceiver design," *IEEE Trans. Microwave Theory Tech.*, vol. 50, pp. 281–287, Jan. 2002.
- [11] S. Willingham, M. Perrott, B. Setterberg, A. Grzegorek, and B. McFarland, "An integrated 2.5 GHz __ frequency synthesizer with 5 _s settling\ and 2 Mb/s closed loop modulation," in *Proc. ISSCC 2000*, 2000, pp. 138–139.

- [12] P. J. Sullivan, B. A. Xavier, and W. H. Ku, "Low voltage performance of a microwave CMOS Gilbert cell mixer," *IEEE J. Solid-State Circuits*, vol. 32, pp. 1151–1155, July 1997.
- [13] S. Boyd and L. Vandenberghe, *Convex Optimization*. Cambridge, U.K.: Cambridge Univ. Press, 2003.
- [14] S. Cui, A. J. Goldsmith, and A. Bahai, "Energy-efficiency of MIMO and cooperative MIMO in sensor networks," *IEEE J. Select. Areas Commun.*, vol. 22, no. 6, pp. 1089–1098, Aug. 2004.
- [15] Rilischa Dohler, Emeline Lefranc, Hamid Aghvami, Space-Time Block Codes for Virtual Antenna Arrays.
- [16] Aggelos Bletsas, Ashish Khisti, David P. Reed and Andrew Lippman, A Simple Cooperative Diversity Method Based on Network path Selection.