

RFID-Based Anti-theft Auto Security System

Project report submitted in partial fulfillment of the requirement for the degree of
Bachelor of Technology

in

Electronics and Communication Engineering



By

Adish(151054)

Raghav Bawa(151074)

Under the supervision of

(Dr. Vikas Baghel)

to

Department of Electronics and Communication Engineering

Jaypee University of Information Technology Waknaghat, Solan-173234,

Himachal Pradesh

May 2019

Candidate's Declaration

I hereby declare that the work presented in this report entitled “**RFID-Based Anti-theft Auto Security System**” in partial fulfillment of the requirements for the award of the degree of *Bachelor of Technology in Electronics and Communication Engineering* submitted in the department of Computer Science & Engineering and Information Technology, Jaypee University of Information Technology Waknaghat is an authentic record of my own work carried out over a period from August 2018 to December 2018 under the supervision of **Dr. Vikas Baghel**, Assistant Professor(Senior Grade).

The matter embodied in the report has not been submitted for the award of any other degree or diploma.

Adish,(151054)

Raghav Bawa,(151074)

This is to certify that the above statement made by the candidate is true to the best of my knowledge.

Dr. Vikas Baghel

Assistant Professor(Senior Grade)

Computer Science and Engineering / Information Technology

Dated:

CERTIFICATE

This is to certify that the work which is being presented in the project report titled “**RFID-Based Anti-theft Auto Security System**” submitted in partial fulfillment of the requirements for the degree of Bachelor of Technology in Civil Engineering at **Jaypee University of Information Technology, Wagnaghat** is an authentic record of work carried out by **Adish Kauhal (151054)&Raghav Bawa (151074)** under the supervision of **Dr. Vikas Baghel, Assistant Professor** , Department of Electronics And Communications Engineering, Jaypee University of Information Technology, Wagnaghat, Solan , (H.P.).

The above statement made is correct to the best of our knowledge.

Date:

Signature of Supervisor

Dr. Vikas Baghel

Assistant Professor

ECE Department

JUIT, Wagnaghat

Signature of HOD

Dr.

Professor and Head

ECE Department

JUIT, Wagnaghat

Signature of Examiner

External Examiner

ACKNOWLEDGEMENT

We have taken efforts in this project. However, it would not have been possible without the kind support and help of many individuals and organizations. We would like to extend our sincere thanks to all of them.

We are highly indebted to **Dr.Vikas Baghel** for their guidance and constant supervision as well as for necessary information regarding the project and also for their support in completing the project.

We would like to express our gratitude towards our parents and Jaypee University of Information Technology for their kind co-operation and encouragement which helped us in completion of this project.

Our thanks and appreciations also go to our colleague in developing the project and people who have willingly helped us out with their abilities.

TABLE OF CONTENT

S. No.	TOPIC	Page No.
1.	Chapter-1 INTRODUCTION	10 - 11
1.1.	INTRODUCTION	
1.2.	PROBLEM STATEMENT	
1.3.	OBJECTIVES	
1.4.	METHADODOLOGY	
2.	Chapter-2 LITERATURE SURVEY	13
2.1.	THE BASIC OPERATING STRUCTURE OF THE SYSTEM	14
	A. TRANSMITTING UNIT	15
	B. RECEIVING UNIT	16
	C. RF COMMUNICATION MODULE	17
2.2.	RFID-BASED TAG GENERATION	18 - 19
	A. RFID OPERATING SYSTEM	20 - 21
	B. TAG CHARACTERSTICS	22
3.	Chapter-3 SYSTEM DEVELOPMENT	23
3.1	COMPONENTS USED	23 - 27
3.2	DATA IDENTIFICATION AND PROCESSING SYSTEM	27 - 28
4.	Chapter-4 ALGORITHM OF TAG IDENTIFICATION	
4.1	FLOWCHART	29
4.2	INTELLIGENT AUTOMOBILE INTERFACING	30
5.	Chapter-5 FIELD TEST RESULTS AND DISCUSSION	
5.1	TESTING UNDER DIFFERENT CLIMATIC CONDITIONS	31
5.2	TESTING UNDER DIFFERENT DISTORTION CONDITIONS	35
6.	Chapter-6 CODE	39
7.	Chapter-7 CONCLUSIONS	
7.1	CONCLUSION	42

7.2	FUTURE SCOPE	43
8.	REFERENCES	44

LIST OF FIGURES

	Page No.
1. Figure 1 - Basic operating structure of the immobilizing system	14
2. Figure 2.1 - Transmitting Unit	15
3. Figure 2.2 – Block diagram of the transmitting unit	16
4. Figure 3 - Receiving Unit functional block diagram	17
5. Figure 4 - TRXQ1 and RXQ1 RF module	19
6. Figure 5 - Basic Components of RFID System	21
7. Figure 6 - Passive and Active RFID Systems	23
8. Figure 7 –Arduino	24
9. Figure 8 – Relay Module	25
10. Figure 9 - Bluetooth Module	26
11. Figure 10 - Receiver	27
12. Figure 11 – Transmitter	28

LIST OF TABLES

	Page No.
1) Table 1 - THE TECHNICAL SPECIFICATIONS OF WIRELESS MODULES	18
2) Table 2 - DATA IDENTIFICATION WHEN ONE CHARACTER IS MISSING	
3) Table 3 - DATA IDENTIFICATION WHEN FOUR CHARACTERS ARE MISSING	31
4) Table 4- THE VELOCITY OF THE AUTOMOBILE AND CONTROL ACTION	
33	
5) Table 5 – OPERATING DISTANCE IN DIFFERENT WEATHER CONDITIONS	34
6) Table 6 – RECEIVING CYCLE	35

Chapter - 1

INTRODUCTION

1.1. INTRODUCTION

This report exhibits a new radio frequency distinguishing proof (RFID) established automobile immobilizer framework comprising of low hacking possibility and at the same time protecting security of the travelers of the captured automobile. The immobilizer employs the active RFID modernization wherever the label is shaped through almost massive character sets. The accepting unit is insightfully included in three command circuits in the automobile, specifically, start circuit, command unit, and programmed gear growing framework, allowing it to put across the automobile velocity down to focus in a protected systematic manner. The offset theft auto safety framework anticipated here was tested under a variety of typical weather state of affairs and possible sign bending conditions to check its reliability.

1.2. PROBLEM STATEMENT

Automobile commandeering has turned into a consistently expanding issue amid the most recent decade and different auto produces and scientists have created and actualized a scope of hostile to robbery security frameworks to dodge seizing of automobiles. The inactive RFID, contact touchy cautions, cell based gadgets worldwide position framework (GPS) GPS beacons and voice acknowledgment gadgets are a portion of the basic innovations which are utilized in such frameworks. Detached RFID gadgets deal with the self produced label, which can be effectively hacked by RF tuning gadgets. In this manner, the helplessness of hacking of such gadgets is so

high and in the end it doesn't give any insurance whatsoever. Contact touchy alert frameworks could likewise be crippled by utilizing fitting gloves like encasing materials for human body parts. GPS beacons can likewise be utilized yet it requires additional foundation and expensive gadgets to be introduced, which make automobile proprietors apathetic on such gadgets. GSM gadgets also have similar issues of expensive framework and portion charge.

Despite the fact that the current advances are competent to follow or immobilize the captured automobile they will in general showcase a few disadvantages regarding cost and applied shortcomings like danger to automobile proprietor's living. Additionally, amid the most recent decennary, automobile criminals are sufficiently clever to crack the frameworks to prevail on the commandeering process. For instance, Global Positioning System beacon could be expelled from automobile absent a lot exertion and could be embedded to an additional moving automobile to delude the trackers.

1.2. OBJECTIVES

The idea exhibited with the report is novel as far as the produced label, unwavering quality, less impact on human issue, and more extensive accommodating insight as far as automobile immobilizing activity contrasted and the other automobile safety frameworks subsist these days. The principle innovation following this framework is lively RFID, which has the ability to convey an interesting label with exceptionally low hack likelihood. In addition, structure could be acknowledged without lifting a finger at little expenses to run the automobile ruffians to vagueness and eventually get caught with no risk to the automobile proprietor.

1.4. METHODOLOGY

- the fundamental operating configuration of the system.
- the RFID based Label creation
- data recognition and handling system
- the intelligent automobile interfacing part.
- The Field test and analysis

Chapter - 2

LITERATURE SURVEY

2.1. THE BASIC OPERATING STRUCTURE OF THE SYSTEM

The shrewd immobilizing framework fundamentally comprises of transmit unit, accepting unit, and insightful automobile interfacing unit. The information recipient is installed to keen automobile command framework while transmitter unit is held with the automobile proprietor.

This empowers a functioning correspondence way linking the automobile and the proprietor (passenger), as the two finishes are inside working scope of 200m. In contrast to next protection frameworks, which are implanted with the automobile key, in this framework near is generally lofty likelihood of deceiving the criminals likewise empowering the automobile proprietor to immobilize the automobile inside more secure separation. In spite of the fact that this could be actualized utilizing a GPS or cell framework, still the framework hacking likelihood is soaring just as the expense.

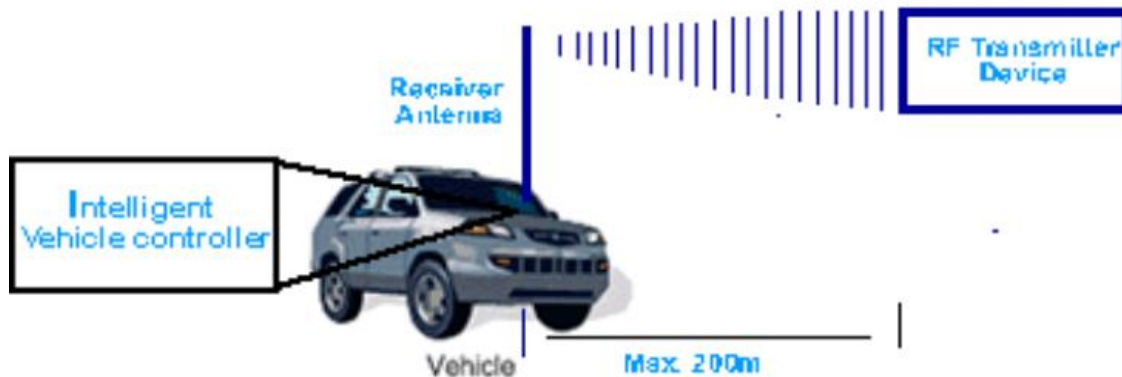

Fig.1

At only one push of the inactivating switch, an exclusive label is transferred by the transmitter, which is received and restored by the receiving system at the automobile. A special data recovery algorithm is used to identify the label received by the microcommander. And appropriate disable signal will be achieved to slow down the automobile velocity to zero in a gradual way. One of the key proposed factor is when automobile is immobilized by means of this label scheme, the automobile can be only be started only by conveying unit's enabling knob.

A. Transmitting Unit

The transmitting unit basically incorporate radio frequency (RF) transmitting element (TRXQ1), Microchip PIC micro-commander (PIC 16F84), on and off switches, and a battery unit.

This is relatively minor and lighter and is helpfully convenient for any unforeseen circumstance

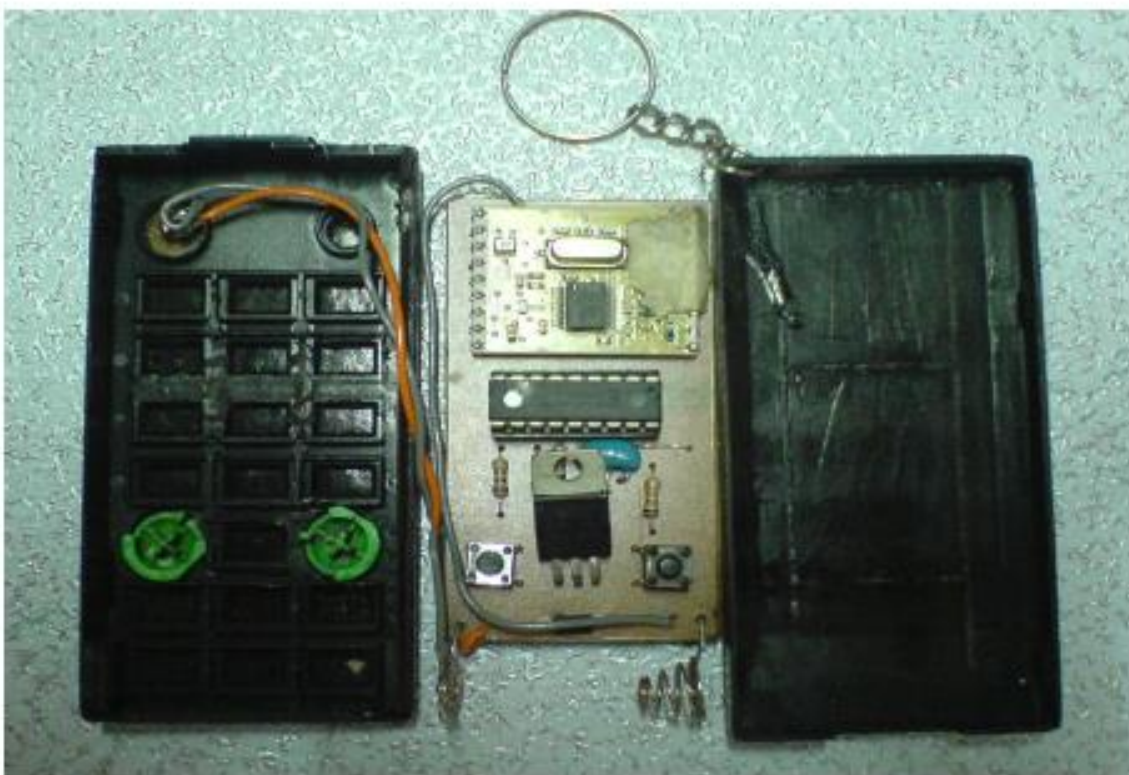

Fig 2.1

The microcommander produces and encrypts the specific label that is transferred to the getting unit at the automobile. The label conveys the data of enactment or shut off of the astute automobile command framework to shut off or restart the automobile. At one empowering or crippling example, the transmitting unit sends the relating one of a kind label multiple times, where the technique will be portrayed instantly. The square chart of the transmitter is given

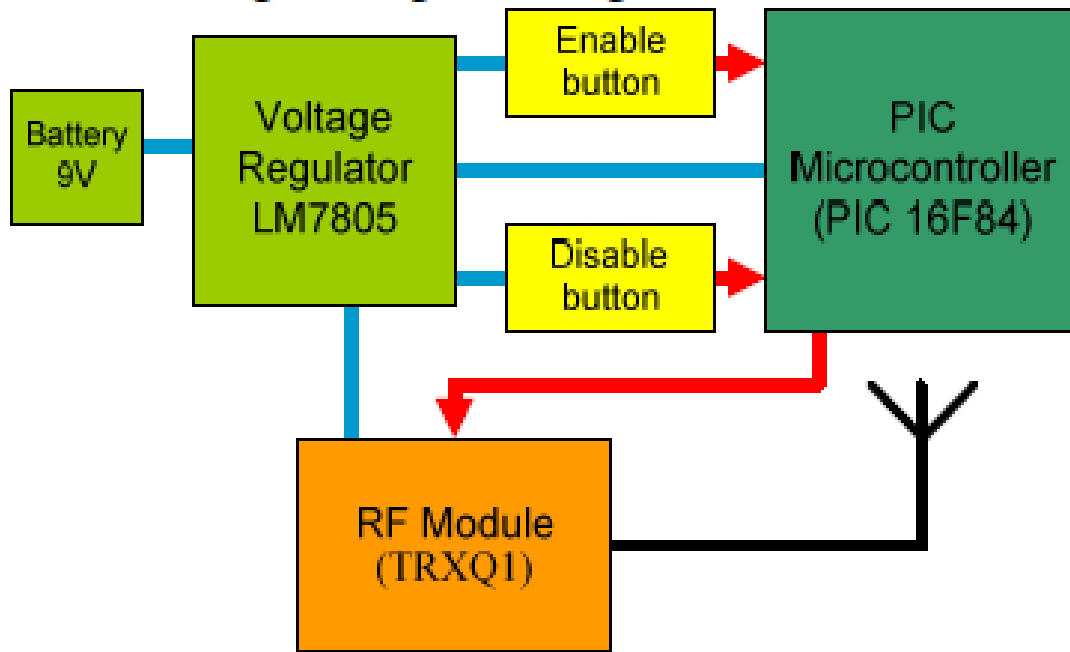

Fig 2.2

B. Receiving Unit

The receiving unit, works unceasingly under the information catching mode to gather the information/label transferred by the transmitter, which comprises of a PIC 16F84 microcommander, RF accepting module (RXQ1), and a commandler circuit. The microcommander is fixated by an uncommon label acknowledgment calculation, conveying a one of a kind sign to clever car command framework that is embedded into car start framework, car command unit, and the programmed rigging evolving framework. Contingent upon the proprietor's prerequisites, the quantity of incapacitating capacities could be installed

to savvy automobile command framework could be expanded. The functional block diagram of the receiving unit is as shown below

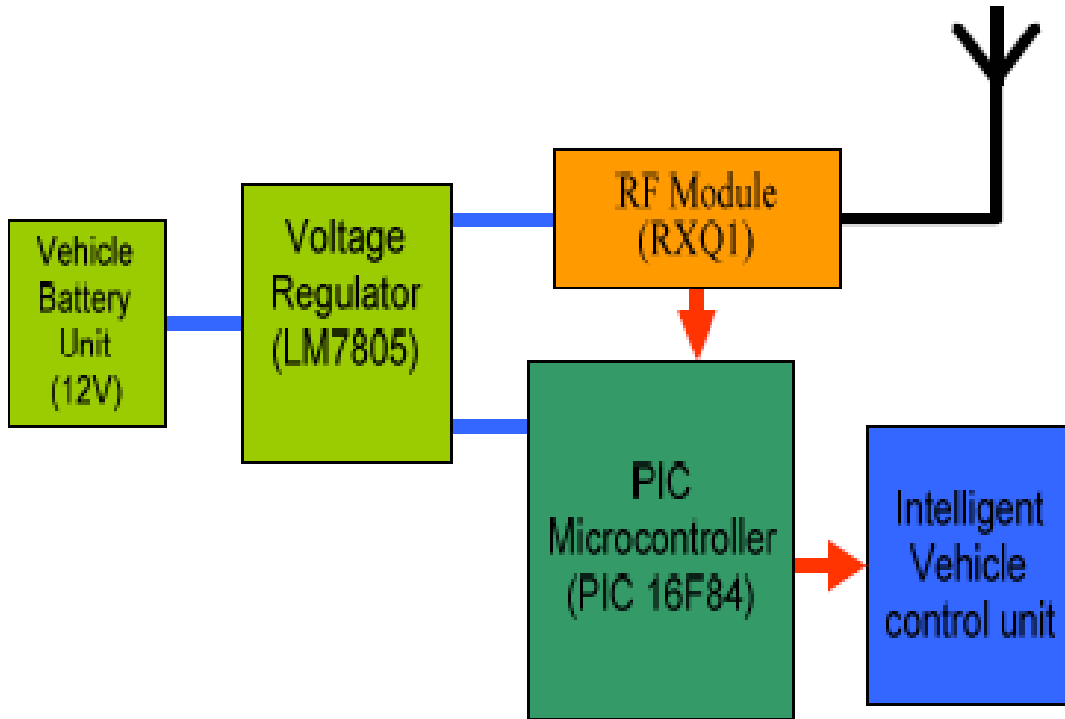

Fig 3

C. RF Communication Modules

The information transmission and procurement framework fundamentally comprises of frequency regulated (FM)low-command radio correspondence entities, where TRXQ1 and RXQ1 are transferring and accepting modules utilized for the remote interchanges interface between the automobile and the proprietor. Under idea working circumstances, they can work inside a scope of 0 to 200m.

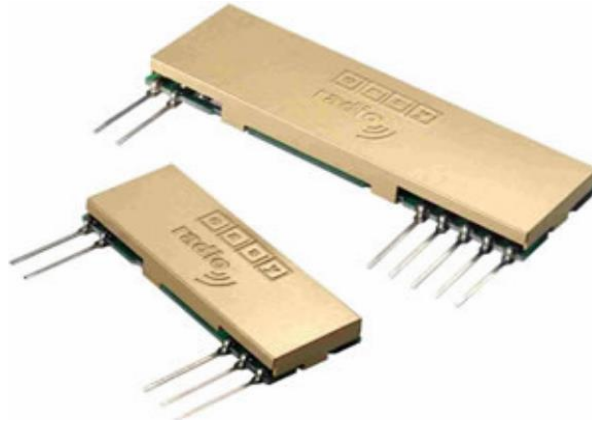

Fig 4

THE TECHNICAL SPECIFICATIONS OF WIRELESS MODULES

Working frequency	433.92 / 434.33 MHz
Receiver sensitivity	-100 dBm
RF power out (transmitter)	5 dBm
FM deviation	+/-15 kHz
Bandwidth	65-85 kHz
Operating temperature	Minimum -20 ⁰ C Maximum +70 ⁰ C
Data bit rate	Minimum 20bps Maximum 20000bps

Table 1

2.2. RFID-BASED LABEL GENERATION

RFID innovation was initially introduced amid World War II, to separate among companion and enemy flying machines, and it was developed in the business segment during the 1970s to follow items as they traveled all the way through the assembling procedure. The most widely recognized uses of the RFID innovation today are visas, item following, transport installments, creature distinguishing proof frameworks and so on.

A. RFID Operating Principle

A RFID framework comprises of three essential segments, to be specific, transmitter/software engineer, receiver and label or transponder. The air interface gives the way to active correspondence between the transmitter and the recipient.

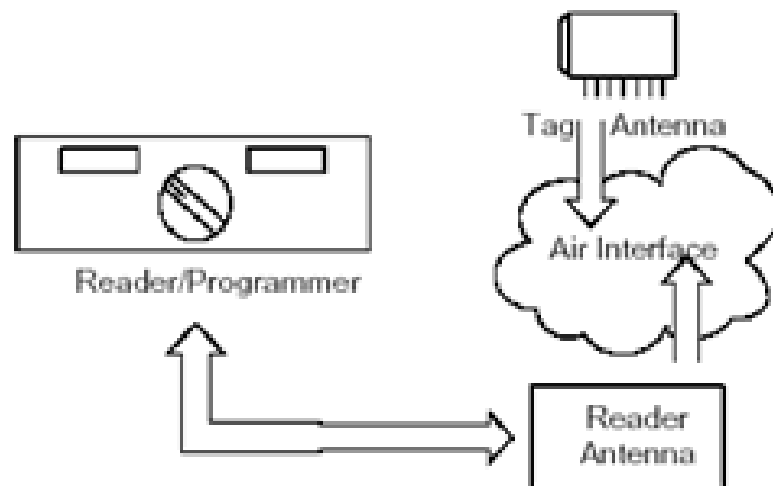

Fig 5

Basically, RFID technology is namely of two differentiated types, the passive and active RFID.

1) Passive Vs Active RFID Systems

Latent RFID labels have no inward power supply. The electric flow actuated in the reception apparatus by the approaching radio frequency signal gives simply sufficient capacity to the correlative metal-oxide semiconductor (CMOS) incorporated circuit in the label to command up and pass on a reaction. Most passive labels send the signal by backscattering the carrier signal from the reader. This implies the receiving wire must be intended to gather command from the approaching signal and furthermore to transmit the outbound backscatter signal. The reaction of a passive RFID label isn't really only an normal code, the mark chip can include non-unusual electronically erasable and programmable ROM (EEPROM) for securing information. Nonattendance of a locally accessible command source suggests that the device can be exceptionally little. In monetarily open things, the low recurrence RFID labels are mounted to a sticker, or under the outside of the case. The fig (an) underneath shows idle RFID structure.

Not in the slightest degree like uninvolved RFID labels, dynamic RFID labels have their very own inside source of power, which is used to command any organized circuits. Active labels are regularly significantly progressively strong (for instance less mix-ups) than inactive labels. The dynamic labels, because of their locally accessible power supply, transmit at higher power levels than uninvolved labels, empowering them to be progressively convincing in "RF tried" circumstances like water(counting individuals/dairy steers, which are for the most part water), metal (shipping compartments, autos), and specifically at longer partitions. Various active labels have helpful extent of numerous meters, and a battery life of up to 10 years. Fig (b) demonstrates a working RFID structure.

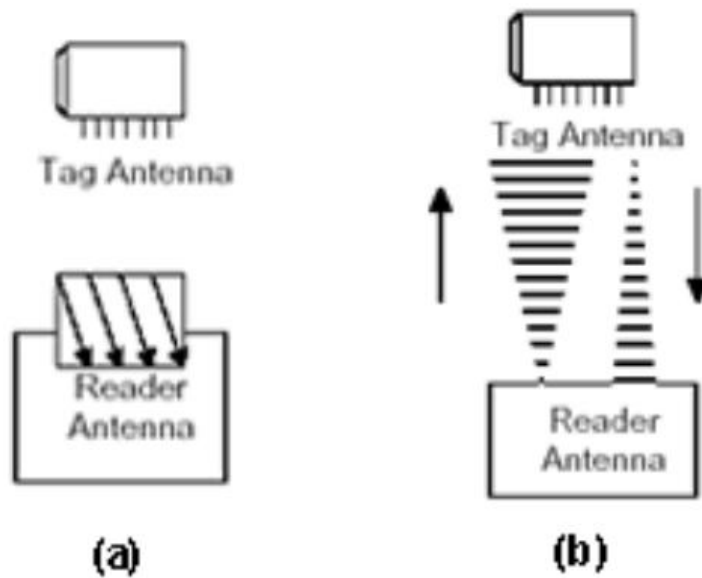

Fig 6

In this methodology, a functioning RFID based framework is utilized which is equipped with a battery that can be used as a midway or complete wellspring of intensity for the label's hardware and radio wire. It has the huge inclinations like longest correspondence extent of any label, the ability to execute free watching and command, the capacity of beginning exchanges, the capacity of performing diagnostics, and the most raised data information exchange limit. The dynamic RFID labels may even be outfitted with independent systems administration in that the labels self-governing decide the best correspondence way.

B. Label Characteristics

The term label refers to tis fundamentally a one of a kind security code sent by the transmitting unit, which essentially contains a six 8-bit characters. The characters are transferred sequentially from the RF correspondence connect to the getting unit where accepting unit reestablishes the characters progressively and checks the legitimacy of the code to empower or debilitate the insightful automobile command framework. The n is an 8-

bit character which could have up to 255 character types. The various blends (S) conceivable through the label are given by

$$S = n \times (n - 1) \times (n - 2) \times (n - 3) \times (n - 4) \times 1$$

The code above comprises of six characters, where last and finishing up characters ought to be same for the coordinating motivations behind both the transmitter and the beneficiary. The essential character of the created label can have n likely qualities and succeeding characters can have 1 value not exactly the earlier character to maintain a strategic distance from the reiteration. Subsequently, the hacking probability (p(h)) of the framework is given by

$$p(h) = \frac{1}{n \times (n - 1) \times (n - 2) \times (n - 3) \times (n - 4) \times 1}$$

The hacking likelihood of this system is of the order of 10^{-14} and, under all condition, hacking of this system is expressively problematic compared to other systems.

Chapter - 3

SYSTEM DEVELOPMENT

3.1. COMPONENTS USED

- Arduino
- Relay Board
- Bluetooth module
- RFtransmitter and receiver

Arduino - Arduino is an open-source gear and programming association, venture and customer network that structures and creates single-board microcommandlers and microcommandler packs for structure modernized devices and natural things that can identify and command both physically and cautiously. It's things are approved under the GNU Lesser General Public License (LGPL) or the GNU General Public License (GPL), permitting the generation of Arduino sheets and programming dispersal by anyone. Arduino sheets are available financially in preassembled structure or as do-it-without anybody's assistance (DIY) packs



Fig. 7

Relay Board—Hand-off sheets are PC sheets with a variety of transfers and switches. They have info and yield terminals and are intended to command the vollabele supply. Hand-off loads up give autonomously programmable, constant command for every one of a few locally available hand-off channels.

Item determinations incorporates the amount of channels, physical estimations, input range, and yield expand. Hand-off sheets with opto-isolators give separation between command banner and yield commands. Programming based gadgets can be used to create cluster records, and light emanating diodes (LEDs) give are used as visual markers. Most hand-off sheets have 2, 4, 8 or 10 channels. Each direct has a hand-off switch with a yield assessed up beyond what many would consider possible, for instance, 250 VAC/5 amps. Some hand-off sheets have an additional connection for a power pack affiliation. Other can be commandled remotely, or through radio recurrence (RF). RF exchange sheets may use an auto-move estimation to prevent the unapproved square endeavor of transmissions. RF hand-off sheets with transmitters and recipients use different channels.

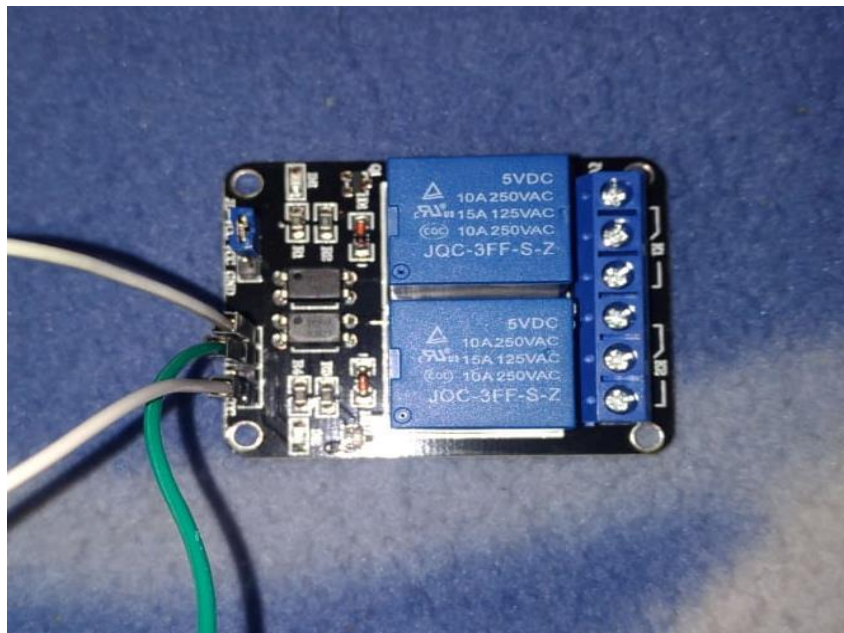

Fig. 8

Bluetooth module - HC-05 Bluetooth Module is an easy to use Bluetooth SPP (Serial Port Protocol) module, designed for transparent wireless serial connection setup. Its communication is via serial communication which makes an easy way to interface with commandler or PC. HC-05 Bluetooth module provides switching mode between master and slave mode which means it able to use neither receiving nor transmitting data.

Specification:

Model: HC-05

Input Vollarbele: DC 5V

Communication Method: Serial Communication

Master and slave mode can be switched.

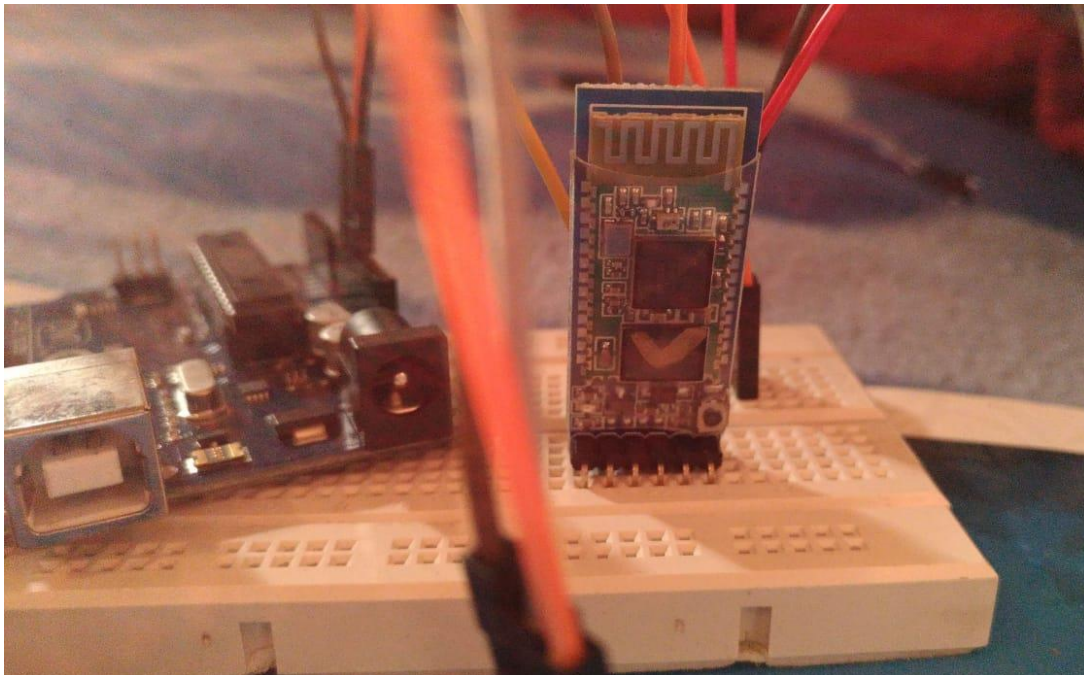

Fig. 9

RF transmitter and receiver.

- RF module (radio frequency module) is a (typically) small electronic device used to transmit just as get radio banner between two devices. In an embedded structure generally charming to talk with another device remotely. This remote correspondence may be rehearsed through optical

correspondence or through radio recurrence (RF) correspondence. For certain applications the method of choice is RF since it doesn't require perceptible pathway. RF trades merge a transmitter and a beneficiary. They are of various types and degrees. Some can transmit up to 500 feet. RF modules are extensively used in electronic structure inferable from the inconvenience of arranging radio equipment. Extraordinary electronic radio structure is broadly confusing a consequence of the affectability of radio circuits and the exactness of parts and plans required to achieve movement on a specific recurrence. In like manner, strong RF correspondence circuit requires careful seeing of the amassing method to ensure that the RF execution isn't horribly impacted. Finally, radio circuits are commonly subject to limits on transferred radiations, and require Conformance testing and certification by a systematization relationship, for instance, ETSI or the U.S. Government Communications Commission (FCC). Thus, structure planners will normally design a circuit for an application which requires radio correspondence and after that "drop in" a pre-made radio module rather than undertaking a discrete structure, saving time and money on progression.

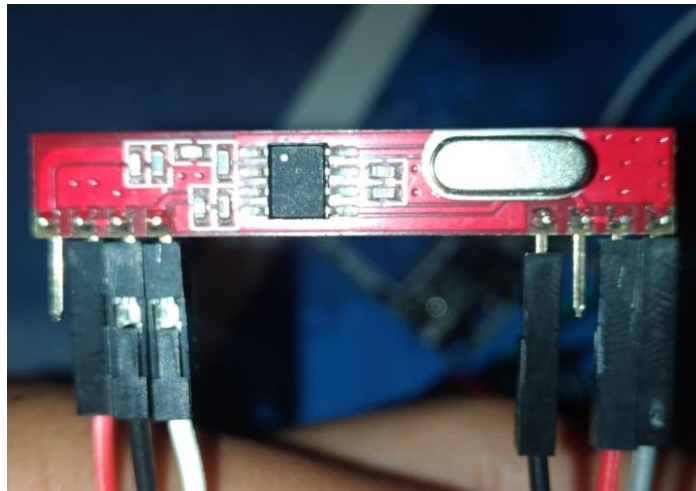

Fig. 10



Fig. 10

3.2. DATA IDENTIFICATION AND PROCESSING SYSTEM

The data ID and dealing with is done at the not exactly alluring end microcommandler, where remarkable figuring is used to perceive the code even more accurately. At the point when the sign is led by the source there is a likelihood of passing on a bended label at the primary succession of communicate. Along these lines, the name will be sent on numerous occasions at one trading case. The not exactly alluring end conspicuous verification estimation is set up to do precisely recognizing the code under in every way that really matters experienced distortion conditions. At first, at the not exactly alluring end, each and every 8-bit character will be consigned to five components (since essential and last character of the label is the alike) in consecutive solicitation. At the point when the data has been gotten from the transmitter at each sole agreeable grouping, the authenticity of the code will be looked at through the doled factors in consecutive solicitation and once they exhibit the correct character list in successive solicitation, the major debilitation or enable sign will be sent by the microcommandler to the sharp automobile command unit. The stream outlines in exhibits the principal convenience of the not exactly attractive end Microcommandler estimation. In an enormous part of the RFID-based systems, there is a

credibility of losing mark characters of the essential name sent by the getting unit. Underneath such conditions, the not exactly attractive end should have the limit of perceiving the undermined mark precisely in order to respond viably. The procedure that we present in this assignment has the basic capacity of helping the polluted labels since transmitting unit generates 7 labels in the meantime to the getting unit at one catch press by the customer.

Chapter - 4

Algorithm of Label Identification

4.1. FLOWCHART

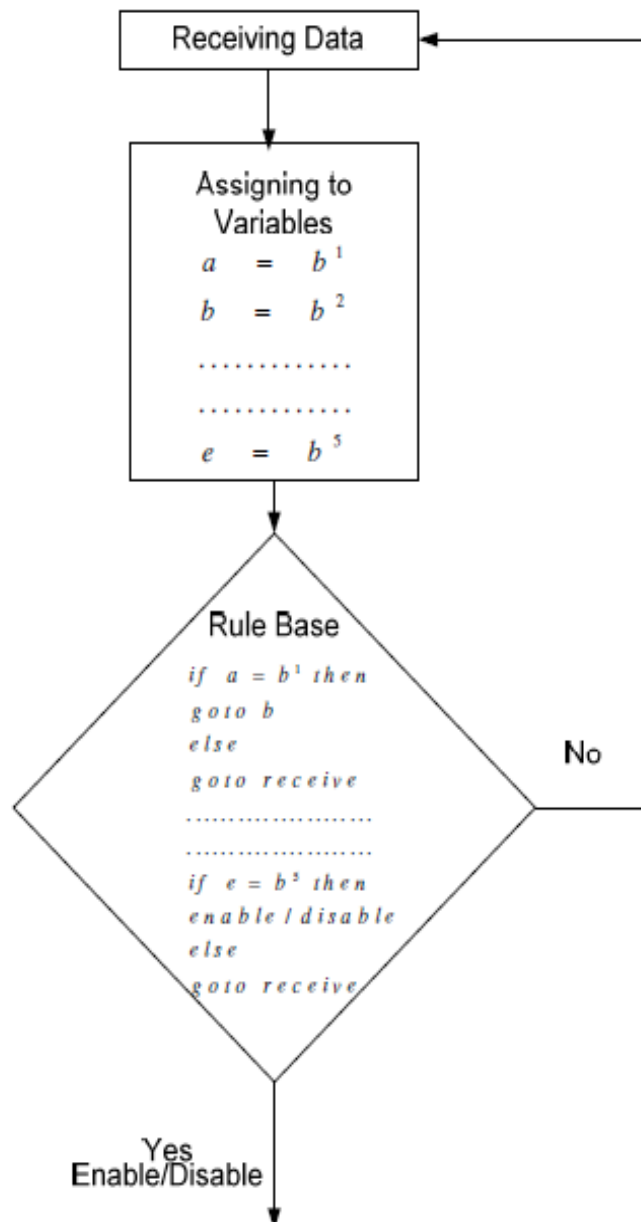

To further intricate, the sent label is 1 2 3 4 5 1 b b b b b , and the initial character of the first label transferred by the transmitter is mislaid. The precisecredentials of the label under such a situation is described in Table below.

DATA IDENTIFICATION WHEN ONE CHARACTER IS MISSING

Assigned Variable	Receiving cycle	
	1	2
<i>a</i>	b^2	b^1
<i>b</i>	b^3	b^2
<i>c</i>	b^4	b^3
<i>d</i>	b^5	b^4
<i>e</i>	b^1	b^5

Table 2

As showed in table II (the box indicates the correct label), under label corruption state, the receiving algorithm can recognize the label at the 2nd receiving cycle. Consider the state of losing the first 4 characters of the label and the Identification Process is as follows

DATA IDENTIFICATION WHEN FOUR CHARACTERS ARE MISSING

Assigned Variable	Receiving cycle				
	1	2	3	4	5
<i>a</i>	b^5	b^4	b^3	b^2	b^1
<i>b</i>	b^1	b^5	b^4	b^3	b^2
<i>c</i>	b^1	b^1	b^5	b^4	b^3
<i>d</i>	b^2	b^1	b^1	b^5	b^4
<i>e</i>	b^3	b^2	b^1	b^1	b^5

Still, the algorithm is able to recover the tag under worst distortion condition. Therefore, seven receiving cycles guarantee the correct identification of the tag under any tag corruption situation.

Table 3

4.2. INTELLIGENT AUTOMOBILE INTERFACING

When the label is basically distinguished by the microcommandler, it is important to convey the debilitating sign to the clever automobile commanding unit (see Fig.). The smart automobile command framework, essentially holds the start framework, programmed gear evolving framework, and automobile command supply framework. One of the essential allotments of this interfacing is to incapacitate the overhead elements of the automobile keenly to halt the car out and about that is being seized. When the impairing signal is transferred by the locally available recipient unit microcommandler, the shrewd command unit microcommandler will mull over the velocity of the automobile and conveys command sign to the over 3 subsystems (likewise observe Fig. 7) to immobilize the automobile inside a protected separation from the spot it was

captured.

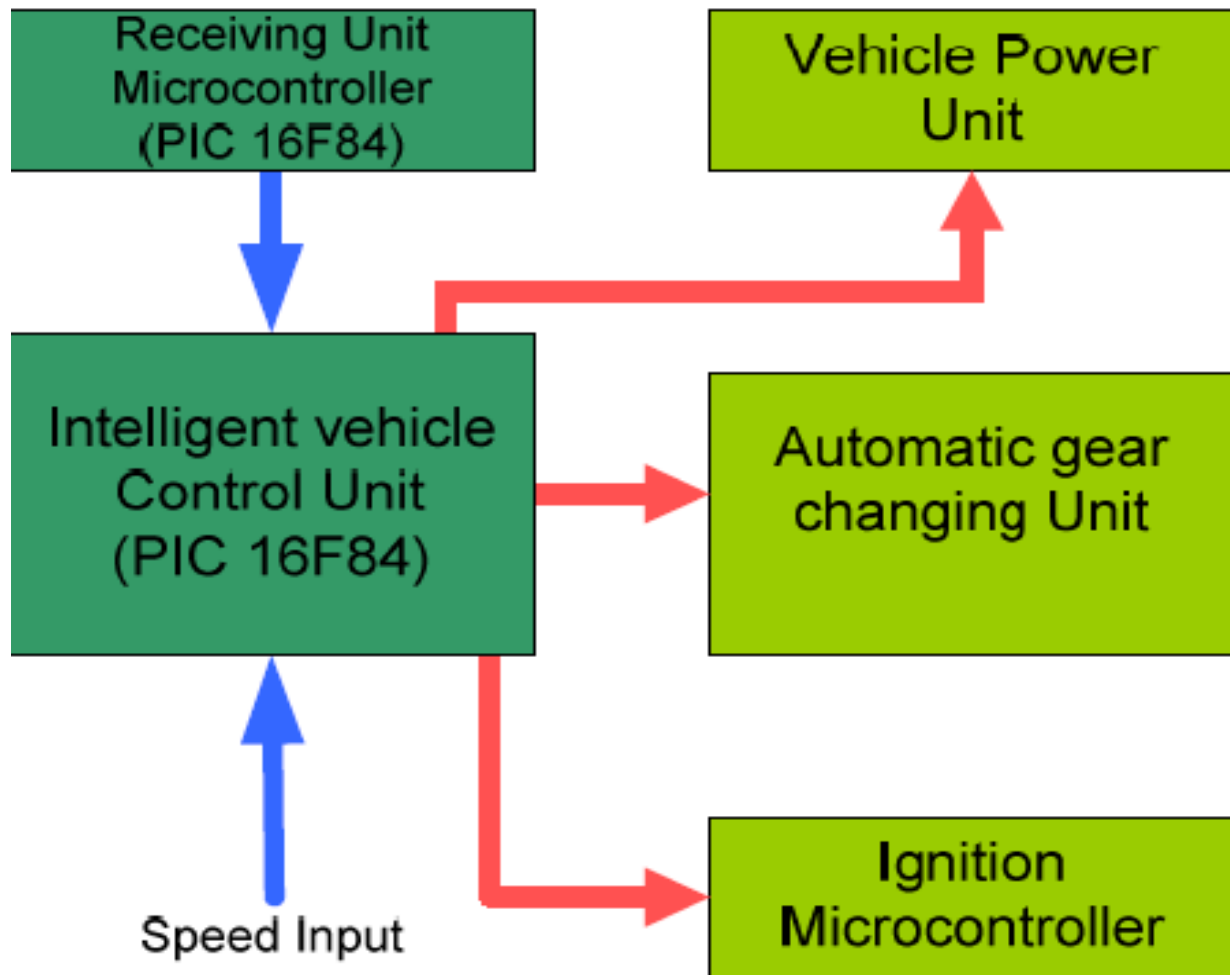

Fig 7

The three different scenarios realize the command order by the astute command unit acknowledged relying upon the present speed of the automobile. The basic accentuation is on impair the car start framework and accordingly adventure will be taken if the speed keeps on doing so .The automobile or the car is halted after a 1.0-1.5 km travel after the label is perceived by the receiving framework. The command by the framework at various speed levels is as demonstrated as follows

THE SPEED OF THE VEHICLE AND CONTROL ACTION

Speed (km per hour)	Control Action
0-30	Ignition system off / Neutral gear/ Vehicle power off
30-60	Ignition system off / Neutral gear
Above 60	Ignition system off

Table 4

Chapter - 5

FIELD TEST RESULTS AND DISCUSSION

5.1. TESTING UNDER DIFFERENT CLIMATIC CONDITIONS

The experimentation of the system is tried in various weather conditions to measure the reliability, which being, rainy, cloudy, windy, and sunny weather circumstances. In these situations, the functioning distances are tested and the results are attained as shown below in table V.

THE OPERATING DISTANCE IN DIFFERENT WEATHER CONDITIONS

Weather condition	Operating distance(m)
rainy weather	171
cloudy weather	191
windy weather	194
bright weather	202

Table 5

Thus, the system is totally reliable in all weathers in a range of 170-200m.

5.2. TESTING UNDER DIFFERENT DISTORTION CONDITIONS

The working of the system for the data capturing ability and reliability was verified under unlike distortion conditions. Thus, first the label was purposely sent inaccurate for checking the competence of detection of label.

The label initially generated was $b^2 b^3 b^4 b^1$

and then right label was delivered to the receiver unit. As table VI shows, the system stands novel in terms of reliability by successfully recuperating the code sent.

Assigned Variable	Receiving cycle		
	1	2	3
<i>a</i>	b^2	b^2	b^1
<i>b</i>	b^3	b^3	b^2
<i>c</i>	b^4	b^4	b^3
<i>d</i>	b^1	b^5	b^4
<i>e</i>	b^1	b^1	b^5

Table 6

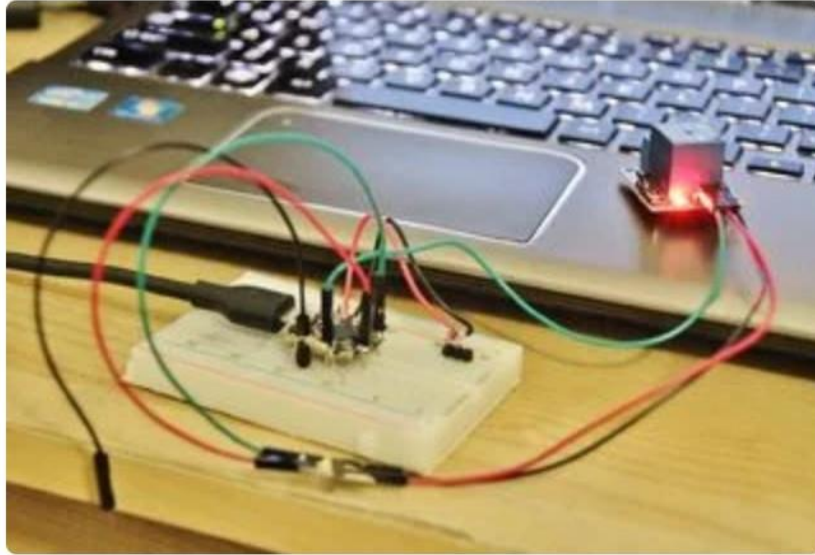

The Arduino compatible Beetle from DFRobot is customized utilizing Arduino IDE by choosing Arduino Leonardo in the Arduino IDE. Tools>Board> Arduino Leonardo.

The "Insect" is a scaled down rendition of Arduino Leonardo, and has same ground-breaking functionalities as Leonardo that is the reason I like this gadget. It's little yet has amazing capacities.

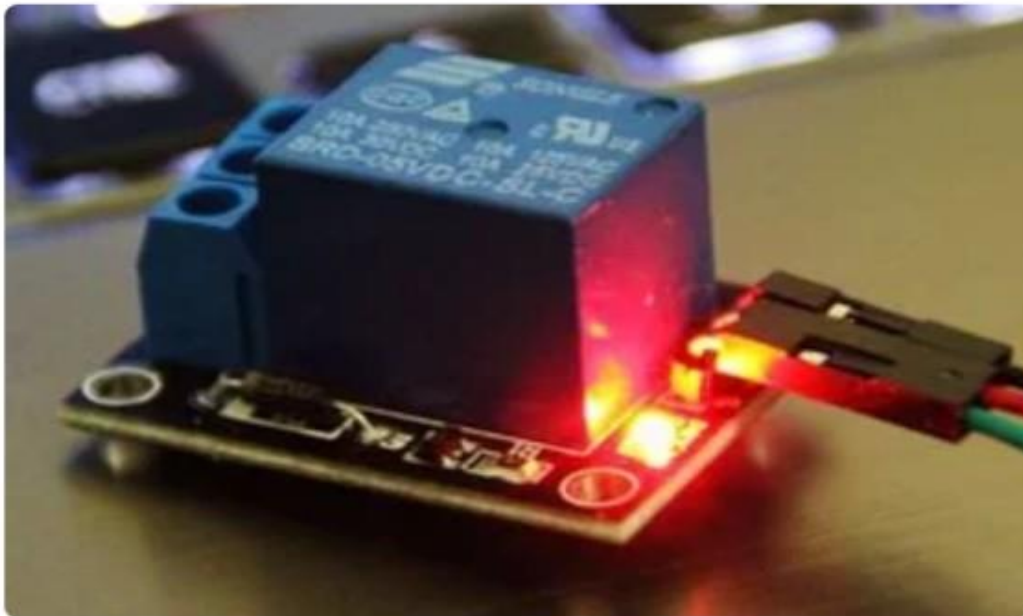
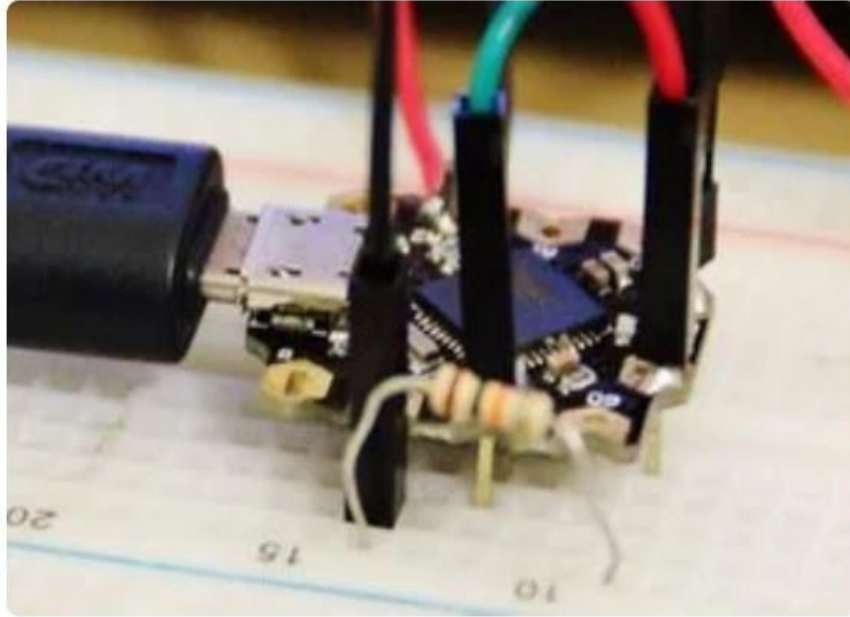

For petrol engines, you can connect this to the fuel pump circuit or ignition circuit. This way, either there would be no fuel supply or spark to the plugs. The engine will then stop running.

For diesel engines, you can connect this into the fuel metering valve circuit. Fuel metering valve

is located into the high pressure pump mounted in the engine itself.

Here are the steps:

1. Consult the wiring diagram in order to determine which part in the circuit is easy for me to connect the device.
2. Locate the fuel pump harness in the floor of the automobile. I cut the supply wire (the red wire before the fuel pump; see the wiring diagram attached) and connect another wire which then I can connect to the relay. One of the wire will be connected to the common terminal of the relay and the other will be connected to the normally closed (NC) terminal of the relay. In this way, if the device is deactivated, the break in the line will be connected back inside the relay connection. If the device is active, the relay will activate and opens the NC contact of the relay, shutting the fuel pump. Fuel supply to the engine will be cut-off and engine will stop running.
3. Connect the power supply to any vollaabele source that will only exist when ignition switch is "ON position".
4. Connect 12V supply to the relay.
5. Connect the trigger wire from relay to the command board.
6. Connect the trigger and install in a hidden location that only you would know.
7. Load the software using Arduino IDE.

Note: Be sure to remove the 12V power supply from the automobile or disconnect the device from the automobile before programming. I'm not sure what will happen but just a caution to everyone.

8. Test the operation.

Chapter - 6

CODE

```
int RL1 = 10;
```

```
int sw1=11; int
```

```
buttonState=0;
```

```
unsigned long timer; // the timer
```

```
boolean timedOut = false; // set to true when timer fired
```

```
unsigned long INTERVAL = 120000; // the timeout interval
```

```
void setup() {
```

```
pinMode(sw1,INPUT); // initilize switch input
```

```
pinMode(RL1, OUTPUT); // initialize RL1 output
```

```
timedOut = false; // allow timer to fire
```

```
timer = millis(); // start timer }

void loop() {

// detect switch state

buttonState = digitalRead(sw1);

// this will turn on relay connected to pin 10

if ((!timedOut && (buttonState=HIGH) ) && ((millis() - timer) > INTERVAL)) {

// timed out timedOut = true; // don't do this again

// you can reset the single shot timer by setting

// timedOut = false;

// timer = millis();

// toggle relay

if (digitalRead(RL1)) {
```

```
digitalWrite(RL1, LOW); // turn the RL1 off by making the vollabele LOW
```

```
} else { digitalWrite(RL1, HIGH); // turn the RL1 on (HIGH is the vollabele level)
```

```
}
```

```
}
```

```
}
```

Chapter - 7

CONCLUSION

7.1. CONCLUSION

The projected anti theft system is rather proficient and dependable under capture condition without apparent harm to the passengers sitting in the automobile and also the driver. At a real world situation the comparatively low hacking chances will rather cause the car captors to true vagueness.

In the perceptive automobile command part in exact has a wide scope of future development since an individual can combine a suitable system relying on the circumstantial issues existing at the place and the environment of the happening to make ideal decisions. The field tests of the whole system have also been confirmed of the dependability of the projected method under contrasting depending conditions. Thus, the projected anti-theft auto security system with an immobilizer produces harmless and dependable resolution for the ever swelling threat of automobile hijackings all over the world.

7.2. FUTURE SCOPE

There is still some scope for future developments in this smart automobile command branch in specific as one can integrate a desired professional method to take judgments those are optimal relying on the situation and its factors existing at the location and the nature of the event. The testing of the total framework has additionally demonstrated the unwavering quality of the proposed framework under various unexpected circumstances. Thus the proposed anti theft

automobile immobilizer can be further taken up for future advancements depending on its technology used it can be rather flexible and has wide scale of future developments.

REFERENCES

Rudy T. Sanders, Lee Fleishman., 1987. “User identifying automobile command and security device”, United States Patent 4754255, May 14,1987

Robert Bosch GmbH, 2001., “Device for protecting a motor automobile against theft “, United States Patent 6856044. Nov 7, 2001

Alfredo J. Berard, James L. Mentzer, David C. Nixon., 1994. “Cellular/GPS system for automobile tracking “, United States Patent 5515043, : August 17, 1994

Eliezer A. Sheffer, Marco J. Thompson.,1992. “Automobile tracking system “, United States Patent 5218367, June 1, 1992

Paul-Andre Roland Savoie, Andre Eric Boulay., 1996,” Automobile tracking system using cellular network”, United States Patent 5895436, April 26, 1996

Auto-Trac Inc., 1992. “Automobile tracking and security system “, United States Patent 5223844. April 17, 1992

Voice Command Systems Inc., 1998. ”Speech commandled automobile alarm system”, United States Patent 5706399. Jun 3, 1996.

RF Solutions Ltd., 2004.” Dual Band FM Wireless Transceivers“,June 200404

Landt, Jerry (2001). “Shrouds of Time: The history of RFID “.AIM, Inc. Retrieved on 2006-05-31.

-Li Zhekun, Rajit Gadh, B.S. Prabhu.,”Applications Of Rfid Technology And Smart Parts In Manufacturing”, Proceedings of DETC’04:ASME 2004 Design Engineering Technical Conferences and Computers and Information in Engineering Conference., Salt Lake City, Utah USA ,September 28-October 2, 2004

Lampe, M. and Strassner, M. (2003). The Potential of RFID for Moveable Asset Management. In Workshop on Ubiquitous Commerce at UbiComp 2003.

Dargan, Gaurav; Johnson,Brian; Panchalingam, Mukunthan; Stratis, Chris (2004). The Use of Radio Frequency Identification as a Replacement for Traditional Barcoding. Retrieved on 2006-05-31.

RFID Journal (2003). “Can RFID Save the Cattle Industry?”.Vertical Focus, December 23,2003. Available <http://www.rfidjournal.com/article/articleview/1032> (22.5.2006).