

To Compare Various Filters for Removal of Noise from ECG Wave

*Project report submitted in partial fulfillment of the requirement for the
degree of*

BACHELOR OF TECHNOLOGY

IN

**ELECTRONICS AND COMMUNICATION
ENGINEERING**

By

**Anshul Goyal-121008
Krishan Choudhary-121009
Arpit Chitransh-121010**

UNDER THE GUIDANCE OF

Mr. Pardeep Garg
Assistant Professor



JAYPEE UNIVERSITY OF INFORMATION TECHNOLOGY, WAKNAGHAT
JUNE 2016

TABLE OF CONTENTS

Topic	Page Number
DECLARATION	iv
SUPERVISOR'S CERTIFICATE	vi
ACKNOWLEDGEMENT	vii
LIST OF ACRONYMS AND ABBREVIATIONS	viii
LIST OF FIGURES	ix
LIST OF TABLES	x
ABSTRACT	xi
CHAPTER-1	
INTRODUCTION	1
1.1 OBJECTIVE	1
1.2 WHAT IS AN ECG WAVE?	1
1.3 ELECTOCARDIOGRAM	2
1.4 BLOCK DIAGRAM	3
1.5 TYPE OF NOISES/ARTIFACTS IN ECG	3
1.5.1 Pacing Spikes	4
1.5.2 Reversed Lead	4
1.5.3 AC Interference	5
1.5.4 Muscle Tremor	5
1.5.5 Wandering Baseline	6
1.5.6 Absolute Heart Block	6
CHAPTER-2	
BACKGROUND MATERIAL	8
2.1 WHAT IS A FILTER?	8
2.2 FILTERS AVAILABLE	8
2.2.1 Savitzky-Golay Filter	8

2.2.2 FIR	8
2.2.3 Median Filter	9
2.2.4 Gaussian Filter	10
2.2.5 Butterworth Filter	10
2.2.6 Notch Filter	12
2.3 WHAT IS AWGN?	13
CHAPTER-3	
DESCRIPTION OF WORK DONE	15
3.1 PERFORMANCE METRICS	15
3.1.1 SNR	15
3.1.2 MSE	17
3.2 FILTERS APPLIED ON NOISY ECG	18
3.3 COMPARISON TABLE	19
3.4 AC INTERFERENCE IN DETAIL	19
3.5 BASELINE WANDERING	23
CHAPTER-4	
MATLAB SIMULATION	24
4.1 MATLAB SIMULATED RESULTS	24
4.2 TREATMENT OF VARIOUS ACTUAL ARTIFACTS IN ECG	27
4.3 RESULT OF FILTERING ON DATABASE	29
CHAPTER-5	
MATLAB CODES	32
5.1 TO REMOVE AWGN	32
5.2 TO REMOVE AC INTERFERENCE (INBUILT)	34
5.3 TO REMOVE AC INTERFERENCE (DATABASE)	36
5.4 TO REMOVE WANDERING BASELINE	39

CONCLUSION	40
REFERENCES	41

DECLARATION

We hereby declare that the work reported in the B-Tech project entitled “**To Compare Various Filters for Removal of Noise from ECG Wave**” “submitted at **Jaypee University of Information Technology, Wagnaghat India**, is an authentic record of my work carried out under the supervision of **Mr. Pardeep Garg**. I have not submitted this work elsewhere for any other degree or diploma.

Anshul Goyal

Krishan Choudhary

Arpit Chitransh

Department of Electronics and Communication Engineering

Jaypee University of Information Technology, Wagnaghat , India

SUPERVISOR’S CERTIFICATE

This is to certify that the work reported in the B-Tech. project entitled “**To Compare Various Filters for Removal of Noise from ECG Wave**”, submitted by **Anshul Goyal, Krishan Choudhary and Arpit Chitransh** at **Jaypee University of Information Technology, Waknaghat , India**, is a bonafide record of their original work carried out under my supervision. This work has not been submitted elsewhere for any other degree or diploma.

Mr. Pardeep Garg

Assistant Professor

Electronics and Communication Engineering

Jaypee University of Information Technology

Date:

ACKNOWLEDGEMENT

We owe a great many thanks to a great many people who have helped and supported us during this project. Our deepest thanks to **Mr. Pardeep Garg (Assistant Professor)**, our project guide for his exemplary guidance, monitoring and constant encouragement throughout the course of this project work. He has taken great pains to go through the project and make necessary corrections as and whenever needed. We are also grateful to **Mr. Mohan Sharma (ECE Project lab)** for his practical help and guidance. We would also like to thank all the faculty members of ECE department without whom the progress of this project would have been a distant reality. We also extend our heartfelt thanks to our family and well-wishers.

Date:

Name of the students:

Anshul Goyal-121008

Krishan Choudhary-121009

Arpit Chitransh-121010

LIST OF ACRONYMS & ABBREVIATIONS

ECG	Electrocardiogram
MSE	Mean Square Error
SNR	Signal to Noise Ratio
Db	Decibels
Hz	Hertz
FIR	Finite Impulse Response
IIR	Infinite Impulse Response
AWGN	Additive White Gaussian Noise
ω	Angular frequency
CWT	Continuous Wavelet Transform
DWT	Discrete Wavelet transform
EEG	Electroencephalogram
WT	Wavelet Transform
FT	Fourier Transform

LIST OF FIGURES

Figure Number	Caption	Page Number
1.1	A Typical ECG Signal	1
1.2	Block Diagram of work done	3
1.3	Artificial pacemaker spikes	4
1.4	Reversed Lead	5
1.5	50Hz AC Interference	5
1.6	Muscle Tremors	6
1.7	Wandering Baseline	6
1.8	Absolute Heart Block	7
3.1	Electrical Representation	23
4.1	Simulated ECG	24
4.2	Noisy ECG	24
4.3	Butterworth Output	25
4.4	Median Output	25
4.5	FIR Output	26
4.6	Savitzky-Golay Output	26
4.7	Noisy ECG	27
4.8	Notch Filter Output	27
4.9	S. Golay Output	28
4.10	ECG From Database	29
4.11	S.Golay Filter Output	29
4.12	Moving Average Filter Output	30
4.13	Notch Filter Output	30
4.14	S. Golay Filter Output	31

LIST OF TABLES

Table Number	Caption	Page Number
3.1	Comparison Table of Filters for AWGN	19
4.2	Comparison Table of Filters for AC interference	28

Abstract

The ECG (Electrocardiogram) signal is continuous in nature and abruptly changing. For taking intelligent health care decisions related with heart diseases such as paroxysmal of heart, arrhythmia diagnosing, ECG signal needs to be pre-process accurately for the further action on it such as extracting the features, wavelet decomposition, distribution of QRS complexes in ECG recordings and related information such as heart rate, classification of the signal by using various classifiers etc.

Digital filters plays very significant role in the analysis of the low frequency components in ECG signal. Numbers of biomedical signals are of low frequency as the basic bandwidth used for the ECG monitoring is from 0.5 Hz to 60 Hz therefore removal of baseline wander and power line interference is a very important step at the pre-processing stage of ECG. Thus to obtain significant results, we have two approaches i.e. filtering approach and wavelet based approach accounting Signal to Noise Ratio, Mean Square Error as performance parameters. During the time we observed that S. Golay filter gives best results among all and we also find that Wavelet Transform method is also very effective for all types of noise which we will look upon later in the coming time. All the observations and results have been simulated on MATLAB.

CHAPTER-1

INTRODUCTION

1.1 Objective

The major objective of the project is to remove the noise present in the ECG signal. The objective also includes the comparison of different filters available to us and to judge them on the basis of different performance metrics like Signal to Noise ratio and Mean Square Error. Our study concludes that these parameters are strong enough to comment on the performance of a filter and reflects the noise filtering capacity of the same.

1.2 What is an ECG wave?

Electrocardiography is a commonly used, procedure for recording electrical changes The records, which are called an electrocardiogram (ECG), show the series of waves that relate to the electrical impulses which occur during each beat of the heart. The results are printed on paper or displayed on a monitor. The waves in a normal record are named P, Q, R, S, and T and follow in alphabetical order as shown in figure . The number of waves may vary, and other waves may be present.[1] [2] [3]

Descriptions of P, Q, R, S, T wave are as follows:

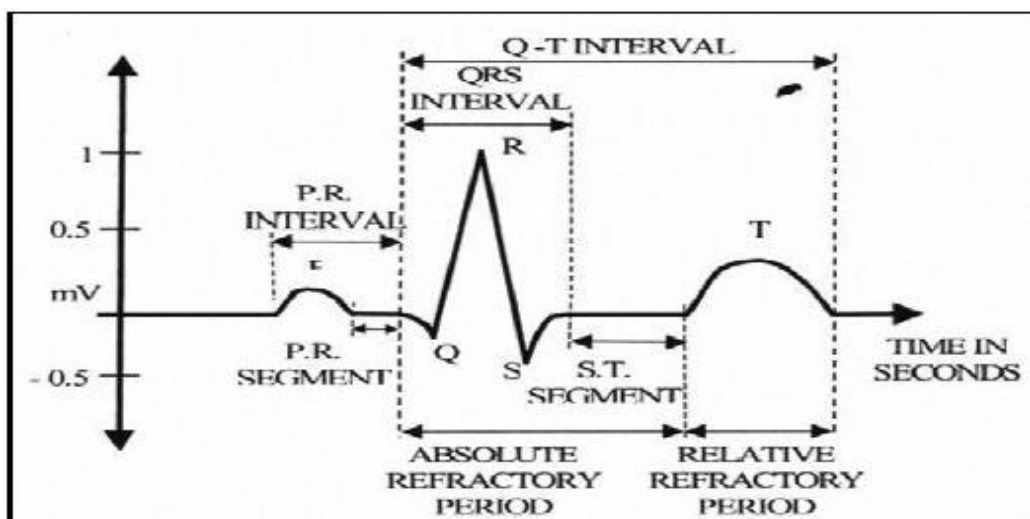

Figure 1.1: [1] A Typical ECG Signal

P wave – it is important to remember that the P wave represents the sequential activation of the right and left atria, and it is common to see notched or biphasic P waves of right and left atrial activation,

PR interval – represents the time necessary to transfer activation from atria to ventricles

QRS complex - The QRS complex is a structure on the ECG that corresponds to the depolarization of the ventricles. Because the ventricles contain more muscle mass than the atria, the QRS complex is larger than the P wave. In addition, because the His/Purkinje system coordinates the depolarization of the ventricles, the QRS complex tends to look "spiked" rather than rounded due to the increase in conduction velocity. A normal QRS complex is 0.06 to 0.10 sec (60 to 100 ms) in duration represented by three small squares or less, but any abnormality of conduction takes longer, and causes widened QRS complexes.

ST segment and T wave - in a sense; the term "ST segment" is a misnomer, because a discrete ST segment distinct from the T wave is usually absent.

More often the ST-T wave is a smooth, continuous waveform beginning with the J-point (end of QRS), slowly rising to the peak of the T and followed by a rapid descent to the isoelectric baseline or the onset of the U wave. This gives rise to an asymmetrical T wave, T wave - represents the repolarization (or recovery) of the ventricles. The interval from the beginning of the QRS complex to the apex of the T wave is referred to as the absolute refractory period. The last half of the T wave is referred to as the relative refractory period (or vulnerable period). [4]-[6]

1.3 Electrocardiogram

The electrical activity of the heart is represented by the ECG signal. The ECG scan is essentially a periodic waveform. One cycle of the blood transfer process from heart to the arteries is represented by the one period of the ECG waveform. This part of the waveform is generated by an electrical impulse originated at sino-atrial node in the right atrium of the heart. The impulses causes contraction of the atria which forces the blood in each atrium to squeeze into its corresponding ventricle. The resulting signal is called the P wave. The atrioventricular node delays the excitation impulse until the blood transfers from atria to the

ventricles is completed, resulting in PR interval of the ECG waveform. The excitation impulse then causes contraction of the ventricles which squeezes blood into the arteries.

This generates the QRS part of the ECG waveform. During this phase the atria are relaxed and filled with blood. The T wave of the waveform represents the relaxation of ventricles. The complete process is repeated periodically, generating the ECG trace.

Each portion of the ECG waveform carries various type of informations for the physician analyzing a patient's heart condition. For example amplitude and timing of the P and QRS portions indicate the condition of cardiac muscle mass. Loss of amplitude indicates muscle damage, whereas increased amplitudes indicates abnormal heart rates. Too long a delay in the atrioventricular node is indicated by very long PR interval. Likewise, blockage of some or all of contraction muscles is reflected by intermittent synchronization between P and QRS waves. Most of these abnormalities can be treated with various drugs and the effectiveness of the drugs can be monitored by observing the ECG waveforms taken after the drug treatment.

1.4 Block Diagram

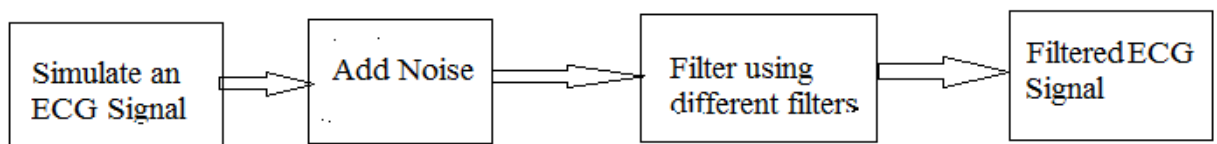

Figure 1.2: Block Diagram of work done

1.5 Types of Noise/Artifacts in ECG

The word artifact is similar to artificial in the sense that it is often used to indicate something that is not natural (i.e. man-made). In electrocardiography, an ECG artifact is used to indicate something that is not “heart-made.” These include (but are not limited to) electrical interference by outside sources, electrical noise from elsewhere in the body, poor contact, and machine malfunction. Artifacts are extremely common, and knowledge of them is necessary to prevent misinterpretation of a heart's rhythm [7].

1.5.1 Pacing Spikes

These are seen in someone whose implanted pacemaker is firing. The sharp, thin spike seen in figure. x-x is an electrical signal produced by an artificial pacemaker. The wide QRS complex that follows it represents the ventricles depolarizing. We say that the "(artificial) pacemaker captures" when it is able to successfully depolarize its intended target. If a pacing spike is not followed by its intended response, we say that it has failed to capture.

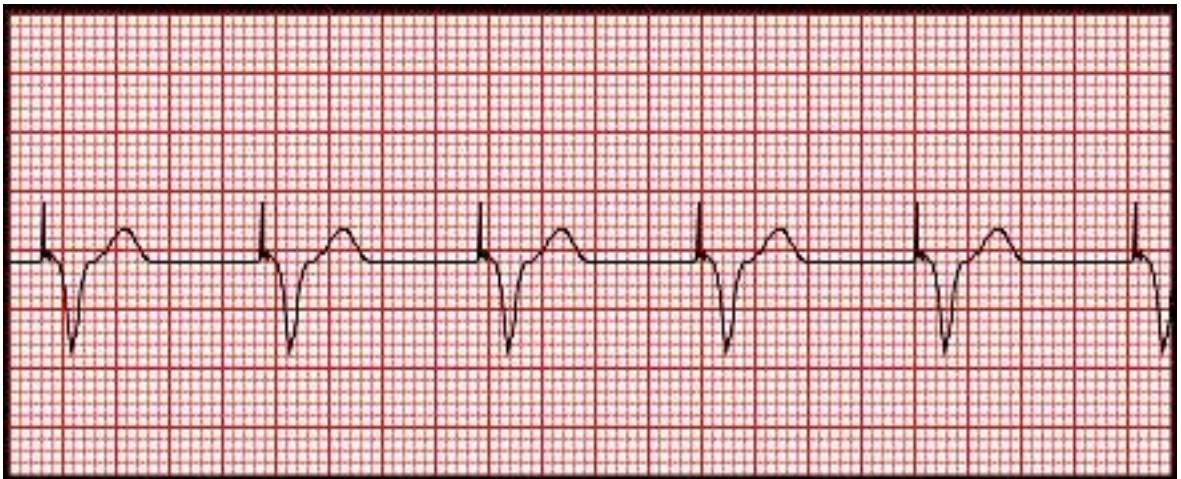

Figure 1.3: [8] Artificial pacemaker spikes

1.5.2 Reversed Leads / Misplaced Electrodes

Electrode/lead placement is very important. If one were to accidentally confuse the red and white lead cables (i.e. place the white one where the red one should go, vice versa), he might get an ECG that looks like figure. In this ECG, we can make out a normal sinus rhythm with all of the waves upside-down. When this happens, you are essentially viewing the rhythm in a completely different lead.

One must also make sure that the lead wires are actually plugged into the machine. If your talkative patient shows a systole, you should suspect this. Many machines are "smart" in that they can sense common errors of this nature, but many such errors aren't always readily apparent.

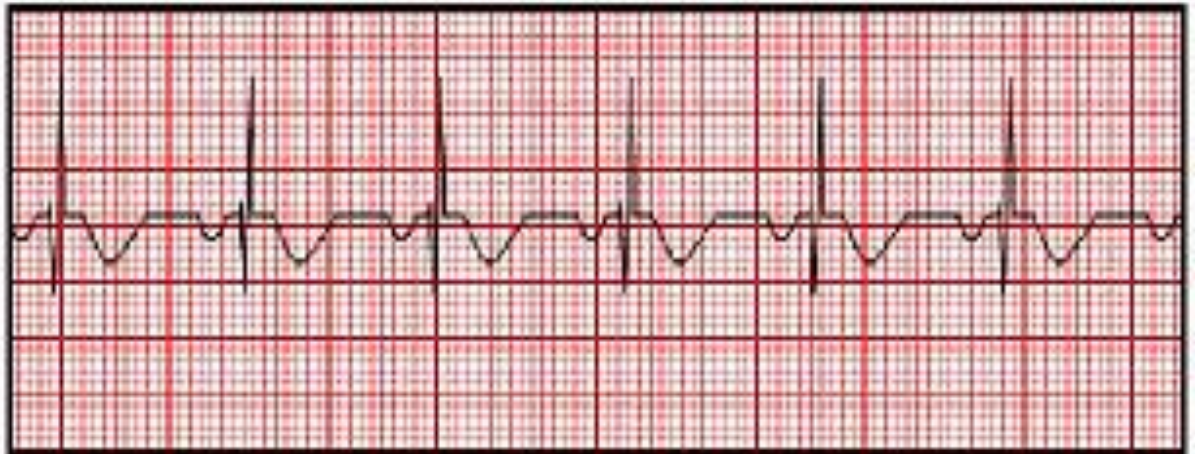

Figure 1.4: [8] Reversed Lead

1.5.3 AC Interference

Alternating current (AC) describes the type of electricity that we get from the wall. In the India, the electricity "changes direction" 50 times per second (i.e. 50 Hz). (Many places in United States use 60 Hz AC electricity.) When an ECG machine is poorly grounded or not equipped to filter out this interference, you can get a thick looking ECG line (as shown in figure). If one were to look at this ECG line closely, he would see 50 up-and-down wave pattern in a given second (25 squares).



Figure 1.5: [8] 50 Hz AC interference

1.5.4 Muscle Tremor / Noise

The heart is not the only thing in the body that produces measurable electricity. When your skeletal muscles undergo tremors, the ECG is bombarded with seemingly random activity. The term noise does not refer to sound but rather to electrical interference. Low amplitude muscle tremor noise can mimic the baseline seen in atrial fibrillation.

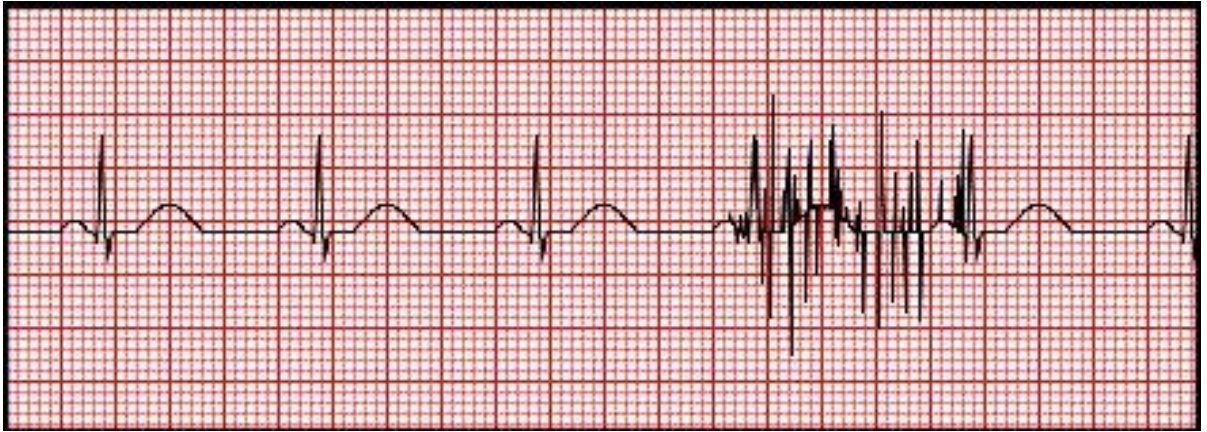

Figure 1.6: [8] Muscle tremors

1.5.5 Wandering Baseline

In wandering baseline, the isoelectric line changes position. One possible cause is the cables moving during the reading. Patient movement, dirty lead wires/electrodes, loose electrodes, and a variety of other things can cause this as well [8] [9].



Figure 1.7: [8] Wandering Baseline

1.5.6 Absolute Heart Block

Absolute heart block (or 4th degree heart block) results from over-exposure to imported-liquor advertisements in magazines. QRS complexes are wide and bottle-shaped and show no relationship with the P wave. It occurs very rarely, and even then, only in fictional settings. This should not be confused with the real arrhythmia complete heart block.

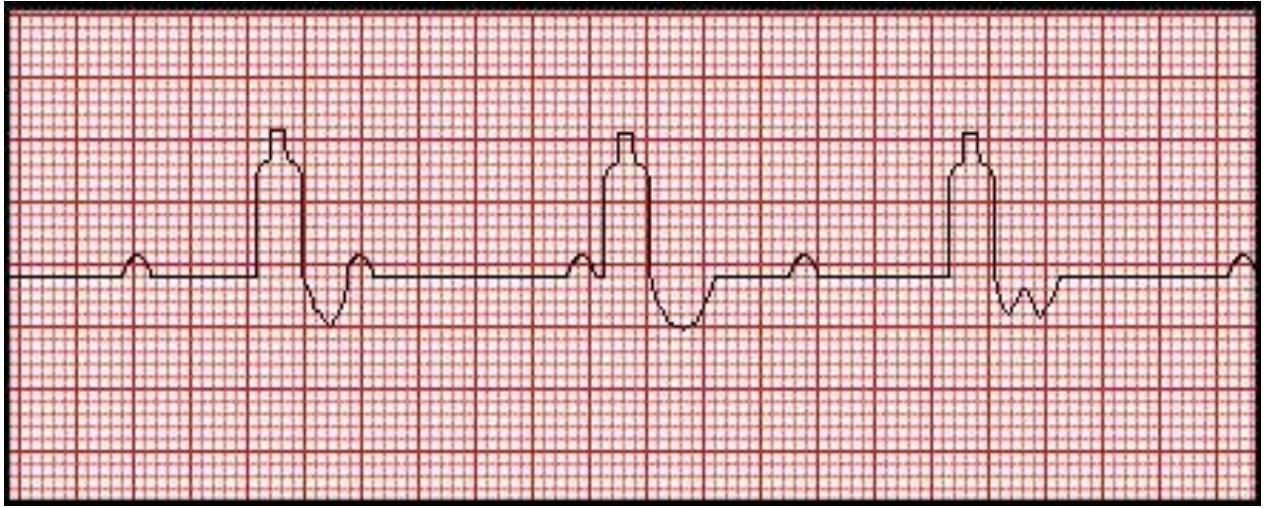

Figure 1.8: [8] Absolute heart block

CHAPTER-2

Background Material

2.1 What is a filter?

In signal processing, a filter is a device or process that removes from a signal some unwanted component or feature. Filtering is a class of signal processing, the defining feature of filters being the complete or partial suppression of some aspect of the signal. Most often, this means removing some frequencies and not others in order to suppress interfering signals and reduce background noise. However, filters do not exclusively act in the frequency domain; especially in the field of image processing many other targets for filtering exist.

2.2 Filters available

2.2.1 Savitzky - Golay Filter

A Savitzky–Golay filter is a digital filter that can be applied to a set of digital data points for the purpose of smoothing the data, that is, to increase the signal-to-noise ratio without greatly distorting the signal. This is achieved, in a process known as convolution, by fitting successive sub-sets of adjacent data points with a low-degree polynomial by the method of linear least squares. When the data points are equally spaced, an analytical solution to the least-squares equations can be found, in the form of a single set of "convolution coefficients" that can be applied to all data sub-sets, to give estimates of the smoothed signal, (or derivatives of the smoothed signal) at the central point of each sub-set. The method, based on established mathematical procedures, was popularized by Abraham Savitzky and Marcel J. E. Golay who published tables of convolution coefficients for various polynomials and sub-set sizes in 1964.^{[3][4]} Some errors in the tables have been corrected. The method has been extended for the treatment of 2- and 3-dimensional data.

2.2.2 FIR Filter

In signal processing, a finite impulse response (FIR) filter is a filter whose impulse response (or response to any finite length input) is of finite duration, because it settles to zero in finite

time. This is in contrast to infinite impulse response (IIR) filters, which may have internal feedback and may continue to respond indefinitely (usually decaying).

The impulse response (that is, the output in response to a Kronecker delta input) of an N th-order discrete-time FIR filter lasts exactly $N + 1$ samples (from first nonzero element through last nonzero element) before it then settles to zero.

FIR filters can be discrete-time or continuous-time, and digital or analog.

2.2.3 Median Filter

In signal processing, it is often desirable to be able to perform some kind of noise reduction on an image or signal. The median filter is a nonlinear digital filtering technique, often used to remove noise. Such noise reduction is a typical pre-processing step to improve the results of later processing (for example, edge detection on an image). Median filtering is very widely used in digital image processing because, under certain conditions, it preserves edges while removing noise

Algorithm description

The main idea of the median filter is to run through the signal entry by entry, replacing each entry with the median of neighboring entries. The pattern of neighbors is called the "window", which slides, entry by entry, over the entire signal. For 1D signals, the most obvious window is just the first few preceding and following entries, whereas for 2D (or higher-dimensional) signals such as images, more complex window patterns are possible (such as "box" or "cross" patterns). Note that if the window has an odd number of entries, then the median is simple to define: it is just the middle value after all the entries in the window are sorted numerically. For an even number of entries, there is more than one possible median, see median for more details

Boundary issues

Note that, in the example above, because there is no entry preceding the first value, the first value is repeated, as with the last value, to obtain enough entries to fill the window. This is

one way of handling missing window entries at the boundaries of the signal, but there are other schemes that have different properties that might be preferred in particular circumstances:

- Avoid processing the boundaries, with or without cropping the signal or image boundary afterwards,
- Fetching entries from other places in the signal. With images for example, entries from the far horizontal or vertical boundary might be selected,
- Shrinking the window near the boundaries, so that every window is full.

2.2.4 Gaussian Filter

In electronics and signal processing, a Gaussian filter is a filter whose impulse response is a Gaussian function (or an approximation to it). Gaussian filters have the properties of having no overshoot to a step function input while minimizing the rise and fall time. This behavior is closely connected to the fact that the Gaussian filter has the minimum possible group delay. It is considered the ideal time domain filter, just as the sinc is the ideal frequency domain filter. These properties are important in areas such as oscilloscopes^[2] and digital telecommunication systems.

Mathematically, a Gaussian filter modifies the input signal by convolution with a Gaussian function; this transformation is also known as the Weierstrass transform.

2.2.5 Butterworth Filter

The Butterworth filter is a type of signal processing filter designed to have as flat a frequency response as possible in the passband. It is also referred to as a maximally flat magnitude filter. It was first described in 1930 by the British engineer and physicist Stephen Butterworth in his paper entitled "On the Theory of Filter Amplifiers".

Butterworth had a reputation for solving "impossible" mathematical problems. At the time, filter design required a considerable amount of designer experience due to limitations of the

theory then in use. The filter was not in common use for over 30 years after its publication. Butterworth stated that:

"An ideal electrical filter should not only completely reject the unwanted frequencies but should also have uniform sensitivity for the wanted frequencies".

Such an ideal filter cannot be achieved but Butterworth showed that successively closer approximations were obtained with increasing numbers of filter elements of the right values. At the time, filters generated substantial ripple in the passband, and the choice of component values was highly interactive. Butterworth showed that a low pass filter could be designed whose cutoff frequency was normalized to 1 radian per second and whose frequency response (gain) was

$$G(\omega) = \sqrt{\frac{1}{1 + \omega^{2n}}}$$

where ω is the angular frequency in radians per second and n is the number of poles in the filter—equal to the number of reactive elements in a passive filter. If $\omega = 1$, the amplitude response of this type of filter in the passband is $1/\sqrt{2} \approx 0.707$, which is half power or -3 dB. Butterworth only dealt with filters with an even number of poles in his paper. He may have been unaware that such filters could be designed with an odd number of poles. He built his higher order filters from 2-pole filters separated by vacuum tube amplifiers. His plot of the frequency response of 2, 4, 6, 8, and 10 pole filters is shown as A, B, C, D, and E in his original graph.

Butterworth solved the equations for two- and four-pole filters, showing how the latter could be cascaded when separated by vacuum tube amplifiers and so enabling the construction of higher-order filters despite inductor losses. In 1930, low-loss core materials such as molypermalloy had not been discovered and air-cored audio inductors were rather lossy. Butterworth discovered that it was possible to adjust the component values of the filter to compensate for the winding resistance of the inductors.

He used coil forms of 1.25" diameter and 3" length with plug-in terminals. Associated capacitors and resistors were contained inside the wound coil form. The coil formed part of the plate load resistor. Two poles were used per vacuum tube and RC coupling was used to the grid of the following tube.

Butterworth also showed that his basic low-pass filter could be modified to give low-pass, high-pass, band-pass and band-stop functionality.

2.2.6 Notch Filter

In signal processing, a band-stop filter or band-rejection filter is a filter that passes most frequencies unaltered, but attenuates those in a specific range to very low levels. It is the opposite of a band-pass filter. A notch filter is a band-stop filter with a narrow stopband (high Q factor).

Narrow notch filters (optical) are used in Raman spectroscopy, live sound reproduction (public address systems, or PA systems) and in instrument amplifiers (especially amplifiers or preamplifiers for acoustic instruments such as acoustic guitar, mandolin, bass instrument amplifier, etc.) to reduce or prevent audio feedback, while having little noticeable effect on the rest of the frequency spectrum (electronic or software filters). Other names include 'band limit filter', 'T-notch filter', 'band-elimination filter', and 'band-reject filter'.

Typically, the width of the stopband is 1 to 2 decades (that is, the highest frequency attenuated is 10 to 100 times the lowest frequency attenuated). However, in the audio band, a notch filter has high and low frequencies that may be only semitones apart.

Examples

In the audio domain

Anti-hum filter

For countries using 60 Hz power lines:

- Low Freq: 59 Hz
- Middle Freq: 60 Hz
- High Freq: 61 Hz

This means that the filter passes all frequencies, except for the range of 59–61 Hz. This would be used to filter out the mains hum from the 60 Hz power line, though its higher harmonics could still be present.

For countries where power transmission is at 50Hz, the filter would have a 49–51 Hz range.

Anti-presence filter

- Low Freq: 1 kHz
- High Freq: 4 kHz

For attenuating presence.

In the radio frequency (RF) domain

Non-linearities of power amplifiers

When measuring the non-linearities of power amplifiers, a very narrow notch filter can be very useful to avoid the carrier frequency. Use of the filter may ensure that the maximum input power of a spectrum analyser used to detect spurious content will not be exceeded.

Wave trap

A notch filter, usually a simple LC circuit, is used to remove a specific interfering frequency. This is a technique used with radio receivers that are so close to a transmitter that it swamps all other signals. The wave trap is used to remove, or greatly reduce, the signal from the local transmitter.^[1]

In the optical domain

Optical notch filters rely on destructive interference.

2.3 What is a AWGN?

Additive white Gaussian noise (AWGN) is a basic noise model used in Information theory to mimic the effect of many random processes that occur in nature. The modifiers denote specific characteristics:

- *Additive* because it is added to any noise that might be intrinsic to the information system.
- *White* refers to the idea that it has uniform power across the frequency band for the information system. It is an analogy to the color white which has uniform emissions at all frequencies in the visible spectrum.

- *Gaussian* because it has a normal distribution in the time domain with an average time domain value of zero.

Wideband noise comes from many natural sources, such as the thermal vibrations of atoms in conductors (referred to as thermal noise or Johnson-Nyquist noise), shot noise, black body radiation from the earth and other warm objects, and from celestial sources such as the Sun. The central limit theorem of probability theory indicates that the summation of many random processes will tend to have distribution called Gaussian or Normal.

AWGN is often used as a channel model in which the only impairment to communication is a linear addition of wideband or white noise with a constant spectral density (expressed as watts per hertz of bandwidth) and a Gaussian distribution of amplitude. The model does not account for fading, frequency selectivity, interference, nonlinearity or dispersion. However, it produces simple and tractable mathematical models which are useful for gaining insight into the underlying behavior of a system before these other phenomena are considered.

The AWGN channel is a good model for many satellite and deep space communication links. It is not a good model for most terrestrial links because of multipath, terrain blocking, interference, etc. However, for terrestrial path modeling, AWGN is commonly used to simulate background noise of the channel under study, in addition to multipath, terrain blocking, interference, ground clutter and self-interference that modern radio systems encounter in terrestrial operation.

CHAPTER-3

Description of Work Done

1. A detailed study of what an ECG signal is and what is the meaning of the different waveforms present in it.
2. What are different types of noise to which an ECG signal is prone?
3. What are different kinds of filters?
4. What are the different parameters on the basis of which we can judge the performance of a filter?

3.1 Performance Metrics

3.1.1 SNR

Signal-to-noise ratio (abbreviated SNR or S/N) is a measure used in science and engineering that compares the level of a desired signal to the level of background noise. It is defined as the ratio of signal power to the noise power, often expressed in decibels. A ratio higher than 1:1 (greater than 0 dB) indicates more signal than noise. SNR higher than 1 or greater than 0 dB indicates more signal power than noise power . While SNR is commonly quoted for electrical signals, it can be applied to any form of signal.[10]

The expression for calculating SNR is as follows:

$$\text{SNR} = 10 \times \log \frac{\sum_0^{N-1} (X_s(n))^2}{\sum_0^{N-1} (X_s(n) - X_r(n))^2}$$

The noise performance and hence the signal to noise ratio is a key parameter for any radio receiver. The signal to noise ratio, or SNR as it is often termed is a measure of the sensitivity performance of a receiver. This is of prime importance in all applications from simple broadcast receivers to those used in cellular or wireless communications as well as in fixed or mobile radio communications, two way radio communications systems, satellite radio and more.

There are a number of ways in which the noise performance, and hence the sensitivity of a radio receiver can be measured. The most obvious method is to compare the signal and noise

levels for a known signal level, i.e. the signal to noise (S/N) ratio or SNR. Obviously the greater the difference between the signal and the unwanted noise, i.e. the greater the S/N ratio or SNR, the better the radio receiver sensitivity performance.

As with any sensitivity measurement, the performance of the overall radio receiver is determined by the performance of the front end RF amplifier stage. Any noise introduced by the first RF amplifier will be added to the signal and amplified by subsequent amplifiers in the receiver. As the noise introduced by the first RF amplifier will be amplified the most, this RF amplifier becomes the most critical in terms of radio receiver sensitivity performance. Thus the first amplifier of any radio receiver should be a low noise amplifier.

Concept of signal to noise ratio SNR

Although there are many ways of measuring the sensitivity performance of a radio receiver, the S/N ratio or SNR is one of the most straightforward and it is used in a variety of applications. However it has a number of limitations, and although it is widely used, other methods including noise figure are often used as well. Nevertheless the S/N ratio or SNR is an important specification, and is widely used as a measure of receiver sensitivity.

Signal to noise ratio for a radio receiver

The difference is normally shown as a ratio between the signal and the noise (S/N) and it is normally expressed in decibels. As the signal input level obviously has an effect on this ratio, the input signal level must be given. This is usually expressed in microvolts. Typically a certain input level required to give a 10 dB signal to noise ratio is specified.

Signal to noise ratio formula

The signal to noise ratio is the ratio between the wanted signal and the unwanted background noise.

$$\text{SNR} = \frac{P_{\text{signal}}}{P_{\text{noise}}}$$

It is more usual to see a signal to noise ratio expressed in a logarithmic basis using decibels:

$$\text{SNR}_{\text{dB}} = 10 \log_{10} \left(\frac{P_{\text{signal}}}{P_{\text{noise}}} \right)$$

If all levels are expressed in decibels, then the formula can be simplified to:

$$\text{SNR}_{\text{dB}} = P_{\text{signal}_{\text{dB}}} - P_{\text{noise}_{\text{dB}}}$$

The power levels may be expressed in levels such as dBm (decibels relative to a milliwatt, or to some other standard by which the levels can be compared).

Effect of bandwidth on SNR

A number of other factors apart from the basic performance of the set can affect the signal to noise ratio, SNR specification. The first is the actual bandwidth of the receiver. As the noise spreads out over all frequencies it is found that the wider the bandwidth of the receiver, the greater the level of the noise. Accordingly the receiver bandwidth needs to be stated.

Additionally it is found that when using AM the level of modulation has an effect. The greater the level of modulation, the higher the audio output from the receiver. When measuring the noise performance the audio output from the receiver is measured and accordingly the modulation level of the AM has an effect. Usually a modulation level of 30% is chosen for this measurement.

3.1.2 MSE

In statistics, the mean squared error (MSE) of an estimator measures the average of the squares of the "errors", that is, the difference between the estimator and what is estimated. MSE is a risk function, corresponding to the expected value of the squared error loss or quadratic loss. The difference occurs because of randomness or because the estimator doesn't account for information that could produce a more accurate estimate. [11]

We have to take the mean of the square of all the error values. We want error as minimum as possible. So the MSE should be as minimum as possible. Lower the MSE better is the filter.

$$\text{MSE} = \frac{\sum_0^{N-1} (X_s(n) - X_r(n))^2}{N - 1}$$

The MSE is the second moment (about the origin) of the error, and thus incorporates both the variance of the estimator and its bias. For an unbiased estimator, the MSE is the variance of the estimator. Like the variance, MSE has the same units of measurement as the square of the quantity being estimated. In an analogy to standard deviation, taking the square root of MSE yields the root-mean-square error or root-mean-square deviation (RMSE or RMSD), which has the same units as the quantity being estimated; for an unbiased estimator, the RMSE is the square root of the variance, known as the standard deviation

3.2 Filters applied on noisy ECG (With AWGN)

1. Butterworth Filter
2. Median Filter
3. FIR Filter
4. Savitzky- Golay Filter

3.3 Comparison table

Table 3.1: Comparison Table of Filters for AWGN

Filters	SNR Before Filtering(db)	SNR After Filtering(db)	MSE
Butterworth	-2.6156	-0.6713	0.0483
Median	-2.6156	0.3611	0.0381
FIR	-2.6156	0.1377	0.0401
Savitzky-Golay	-2.6156	8.0711	0.0064

3.4 AC Interference in detail

The signal voltages in ECG recording are known to be very small and are in the millivolt range, i.e. they have amplitudes of only a few thousand of a volt. The R wave is the curve segment with the greatest amplitude, i.e. approx. 0.5...4 mV depending on the lead. However, segments with considerably smaller voltages, sometimes within the range of 0.1...0.5 mV, are of greater diagnostic value.

If we consider the ratios to all noise fields, we can see that the ratio of the mains voltage (230 V) to the ECG wanted signals is

$$230 \text{ V} / 0.1 \text{ mV} = 2.3 \text{ million}$$

This figure cannot be imagined. It would be like trying to find a thick hair measuring 0.1 mm in diameter in a car park 230 meters wide. Only when such parallels are drawn does it become clear just what demands are made on ECG equipment.

Fortunately, modern circuiting techniques enable these extremely low voltages to be relatively effortlessly processed. However, the human as the source of ECG voltages also acts as an antenna for most varied of noise fields.

Types of interference

The interference which occurs may be divided into four categories:

1. AC interference caused by other types of interference
2. AC interference due to earth circuit or incorrect earthing
3. AC interference due to potential differences
4. Shaking

AC interference

AC interference is interference which arises from superpositioning of the ECG wanted signal with sinusoidal voltages with the mains frequency. It may be recognised by its constant frequency of 50 Hz or 60 Hz depending on the country. Sometimes it can also be 16 2/3 Hz as this is the frequency used by trains.

AC interference caused by other types of interference

AC interference arises from interference of the mains frequency on the test people, on the electrodes and on the patient cable.

Electrode hoses and patient cables normally have such a good shielding that there is little to fear in this respect. Exceptions to this are unshielded electrode cables which in many cases act as an antenna and absorb the interference.

Interferences occur due to electric fields which are generated from

- 1.1 Electric leads in the wall
- 1.2 Chokes in fluorescent lamps
- 1.3 Neighbouring units (e.g. diathermy units)
- 1.4 Large units either in the vicinity or further away (X-ray, lifts).

A commercial lead finder obtainable in a DIY store can be very useful in localising leads behind plaster.

If such a lead is found in the wall behind the patient table for example, this can already be sufficient to switch off all consumers at the end of the lead and thus minimise the current conduction and thus the generated fields. However, the course of current conduction must be known exactly.

Another possibility is the earthing of the patient table, the metal frame of the table being connected to the earthing pins of the ECG recorder by a sufficiently thick cable ($\geq 4\text{mm}^2$). For a permanent solution the table should be contacted by firmly tightening the earthing cable. Other solutions such as crocodile clips or only even winding around a metal part (all already tried!) firstly do not guarantee sufficient contact of low impedance and secondly it is more than likely that cleaning staff or the like will tear them off. A good solution is the use of a ring terminal which is screwed to the screw on the table using a tooth lock washer. If the earthing of the table does not bring about success, mounting metal on the wall is often the only solution. This can take the form of metallized wallpaper or a fly screen. A good connection to the earthing pin of the ECG is necessary in both cases.

Space permitting, simple moving of the equipment often leads to success.

Interference generated by fluorescent lamps is magnetic in nature and are effective usually because they are near the ECG equipment. Simply switching on and off the lamp can determine whether such a lamp causes interference. This problem may be remedied by replacing the choke with a shielded version or by using a totally different kind of lamp.

The effects of other units may also be determined by simply switching them off. In this case too, simply moving the units is often the easiest method.

If interference is generated by large electrical units, moving the ECG room is usually the simplest and cheapest solution. In principle, every room may be shielded from external fields but the costs are considerable. It is very problematic when the fields are generated by large motors or transformers, i.e. when magnetic fields are involved. In this case mu-metal must be used which costs several hundred € per square metre.

AC interference due to earth circuit or incorrect earthing.

This occurs when the protective earth forms a closed ring. An interference voltage similar to a transformer is included in this loop. This can be remedied by interrupting the loop somewhere.

Earth circuits may be avoided by connecting each unit only once with a central earthing socket (normally on the ECG recorder).

Often, little attention is paid to earthing. You cannot depend on any socket outlet, especially not in old buildings where the earthing (connecting the grounded connection to the N-lead) was and is common. In the interests of the patients and personnel (and not least for liability reasons), installation should be carried out according to the appropriate IEC regulations. Earthings over heaters or water pipes may indeed bring about an improvement in AC problems but they are definitely not a permanent and safe solution as such installations are mostly only connected in the cellar to the house earthing and corrosion at the various sites can worsen electrical conductivity slowly but surely.

AC interference due to potential differences

Electrical consumers often cause a reduction in voltage along the power line which is often enough to generate interference in the ECG. This can also easily be resolved by connecting all units belonging to the ECG measuring station to one wall outlet.

Shaking

At first glance, shaking often appears to be AC interference. However, it may easily be distinguished if observed at a high paper feed rate. The frequency in this case is not constant, the amplitude and frequency of every wave is different.

Shaking comes from interference voltages from the patients themselves. For example, when the patient is cold, the musculature contracts. This contraction is controlled by currents from the brain which are, however, also taken up by the ECG electrodes. Another reason can be nervousness; in this case, interference voltage is generated by tensing of the muscles.

The first problem mentioned can be successfully remedied by heating the investigation room. However, psychological methods must be used in the case of nervousness.

The surroundings can often help: an undisturbed view of a park, flowers or even just pictures on the walls are proven methods. The impression of an “investigational piece of machinery for patient processing” should be avoided at all costs. It has been shown that even careful and invisible laying of the different cables helps to avoid the impression that it has something to do with electricity (most people are afraid of the electricity).

The creation of a quiet, familiar atmosphere by personnel is also very helpful. Explaining the investigation and indicating that it is absolutely painless leads to the patient playing a

cooperative part in the proceedings.

3.5 Baseline Wandering

Zero line fluctuations are easily recognised by the movement of the curve upwards or downwards.

They always occur at the transition from the skin to the electrode. A capacitor is formed which has a contact medium as a dielectric.

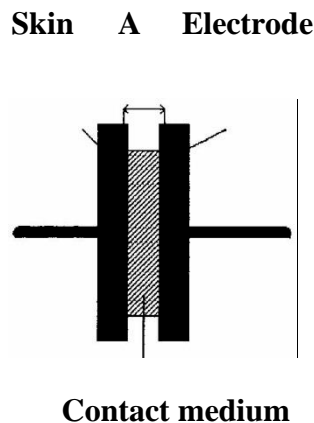

Figure 3.1: Electrical Representation

As is known from physics, the voltage at a capacitor changes when the distance between the boards changes. This is the very effect which induces zero line fluctuations. If the distance of the electrode button to the skin changes, a voltage of several tens of millivolts is generated. The capacitor has a voltage because two different materials which touch each other directly or via a dielectric form a voltaic cell, i.e. a battery. This is also the reason why good electrodes exclusively use silver-silver chloride (Ag-AgCl) as a contact medium. This material is very sensitive to touch, sunrays, chemical decomposition, etc. but has an electrochemical voltage most similar to that of the skin. When this material is used, the voltage generated between the skin and the electrode is minimal.

In principle, a constant DC voltage generated between the skin and the electrode is safe as it can be effortlessly compensated by the input amplifier of the ECG recorder. However, fluctuations in this DC voltage cannot be compensated as they are in the same frequency range as the ECG itself and these fluctuations are all the stronger the higher the voltage.

CHAPTER-4

Matlab Simulation

4.1 Matlab Simulated Results

We have used ECG wave simulated in Matlab. ECG wave is provided as a function in Matlab and added AWGN noise to it which simply gave us the following waves

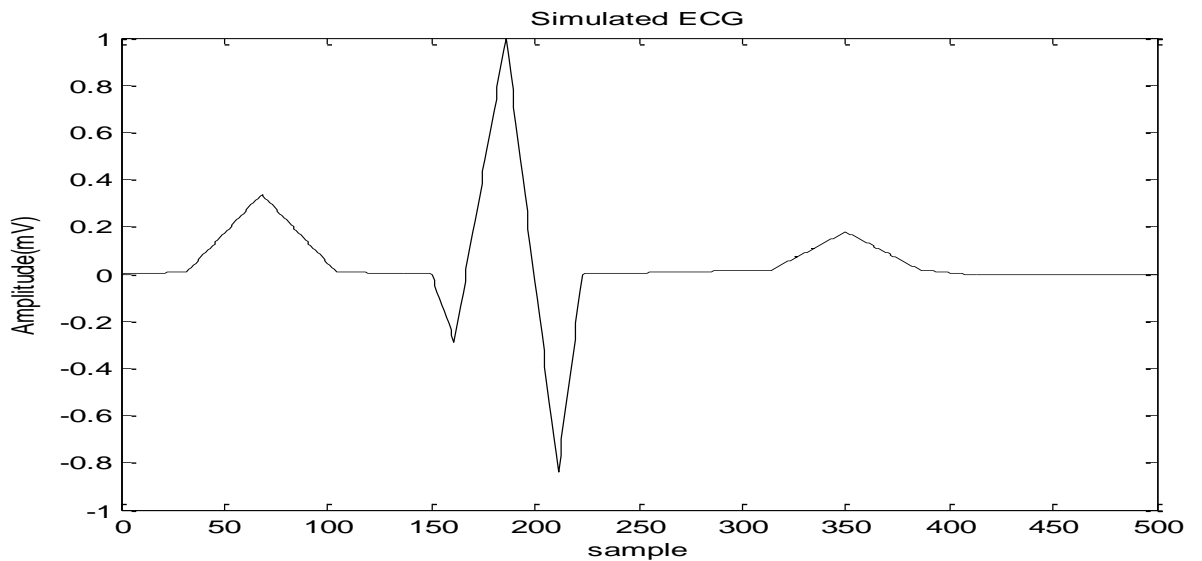

Figure 4.1: Simulated ECG wave

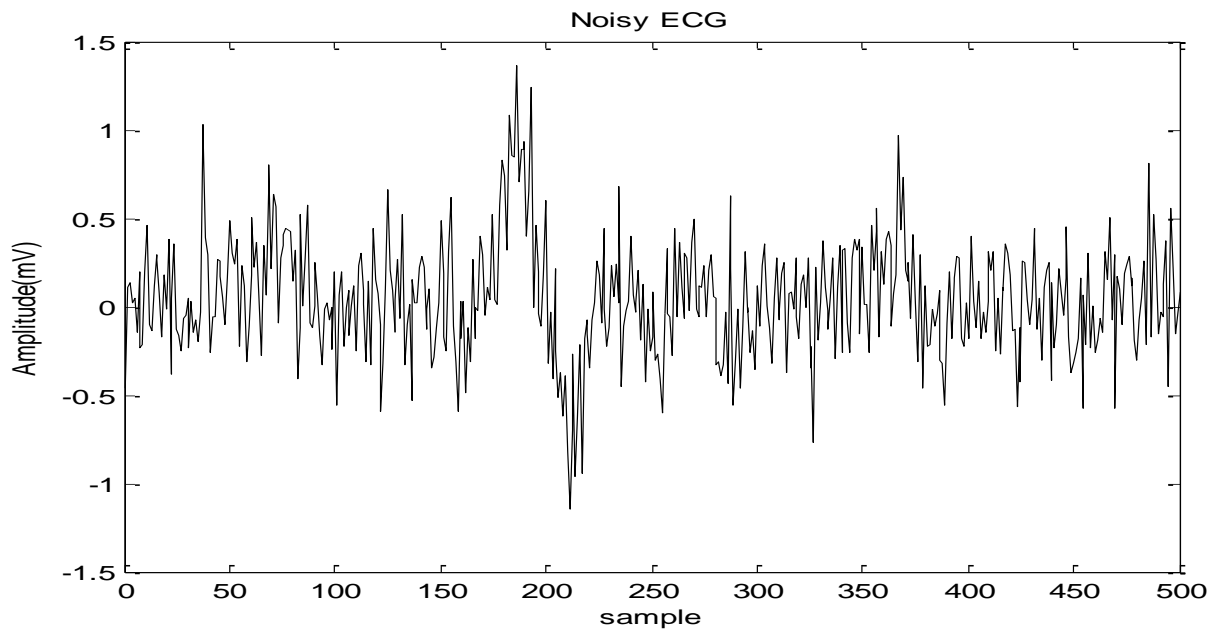

Figure 4.2: Noisy ECG

When different types of existing filters are applied on the noisy ecg wave we got the following outputs.

1. Butterworth Filter

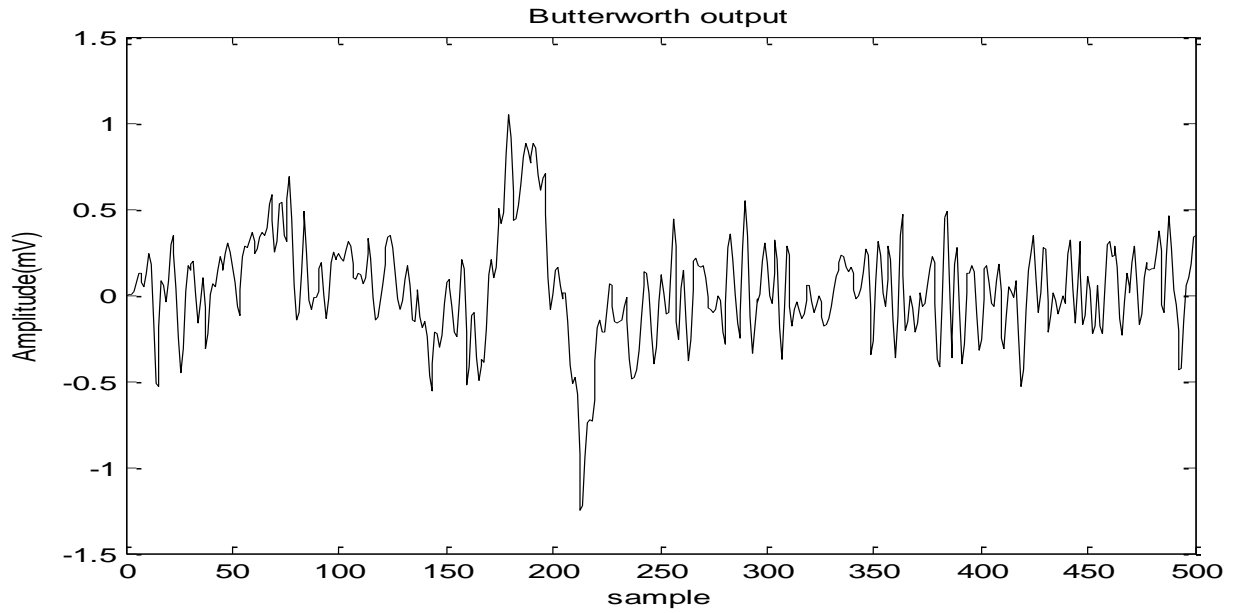

Figure 4.3: Butterworth Output

2. Median Filter

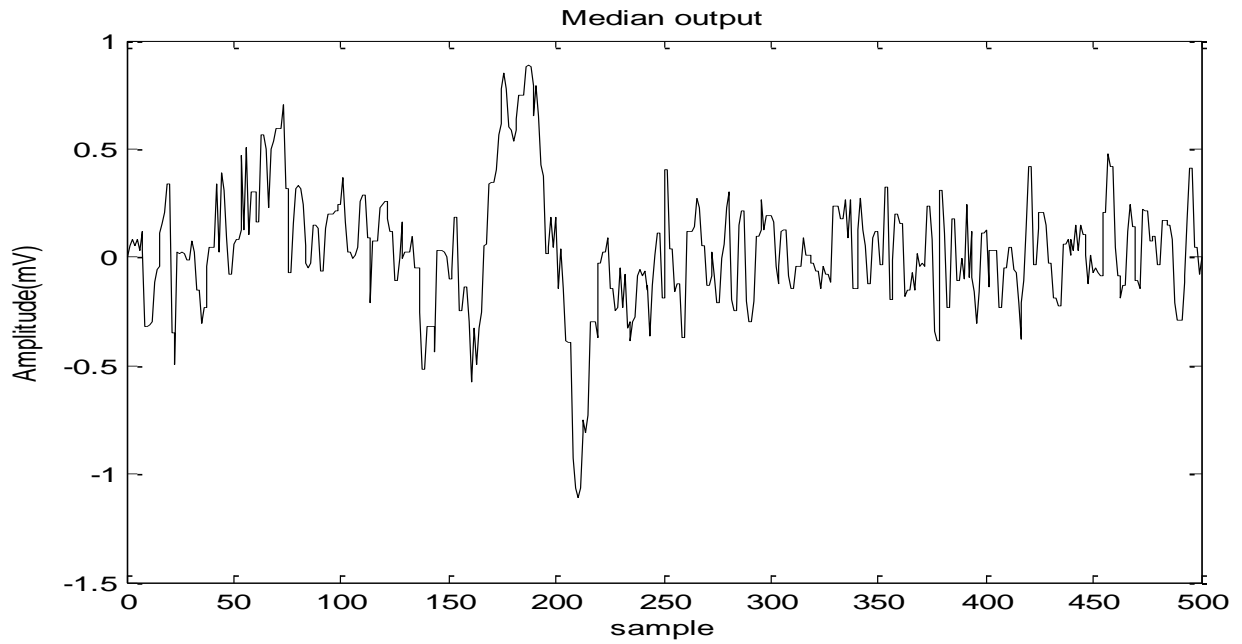

Figure 4.4: Median Output

3. FIR Filter

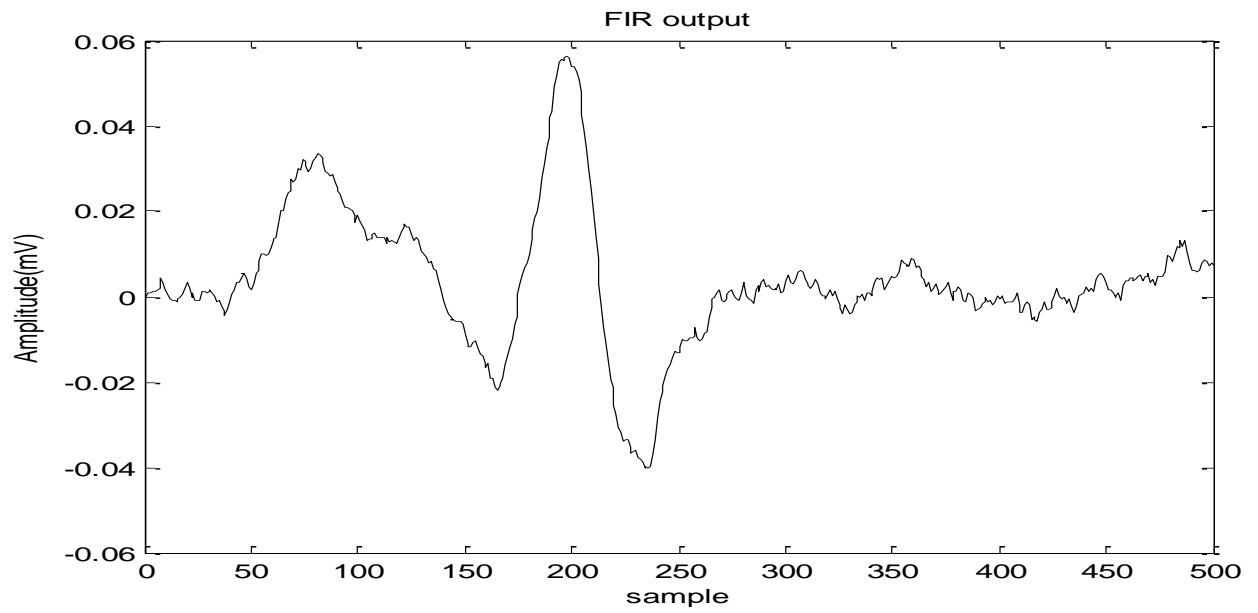

Figure 4.5: FIR Output

4. Savitzky-Golay Filter

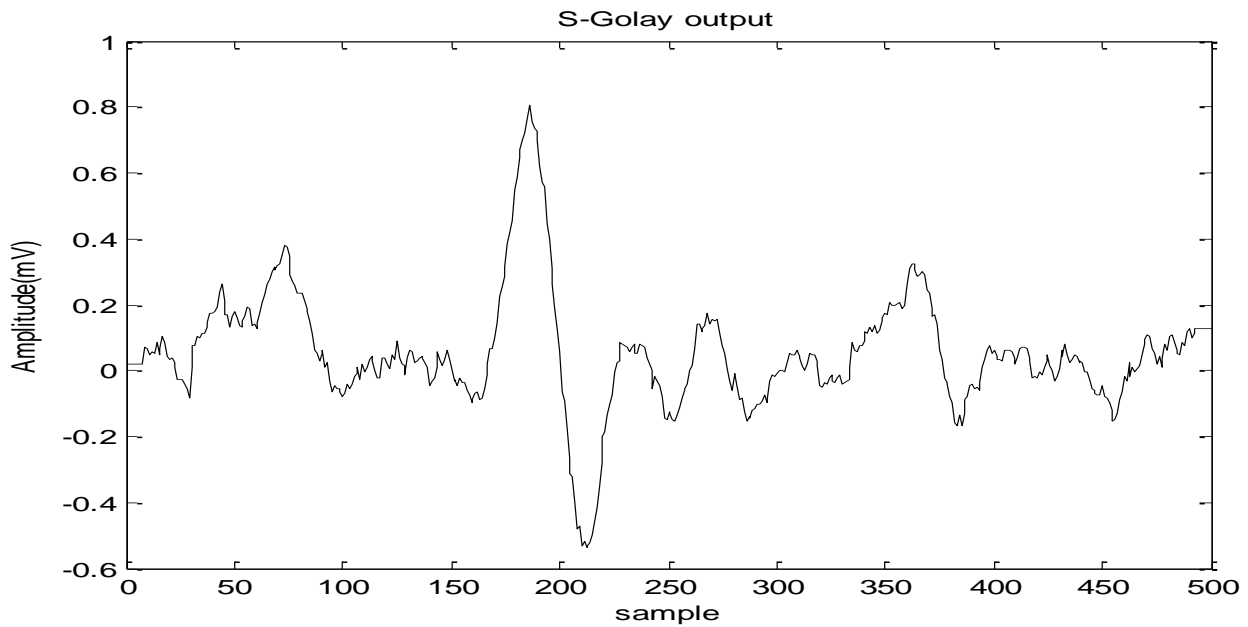

Figure 4.6: Savitzky-Golay Output

From the outputs it is very clear that S. Golay filters is giving some satisfactory results but we can't make any comment until we analyse their performance parameters to test their abilities and the power of filtering.

Thus as per the table 1 we can clearly see that S. Golay performs best in terms of both SNR and MSE.

4.2 Treatment of various actual artifacts in ECG

A. AC Interference

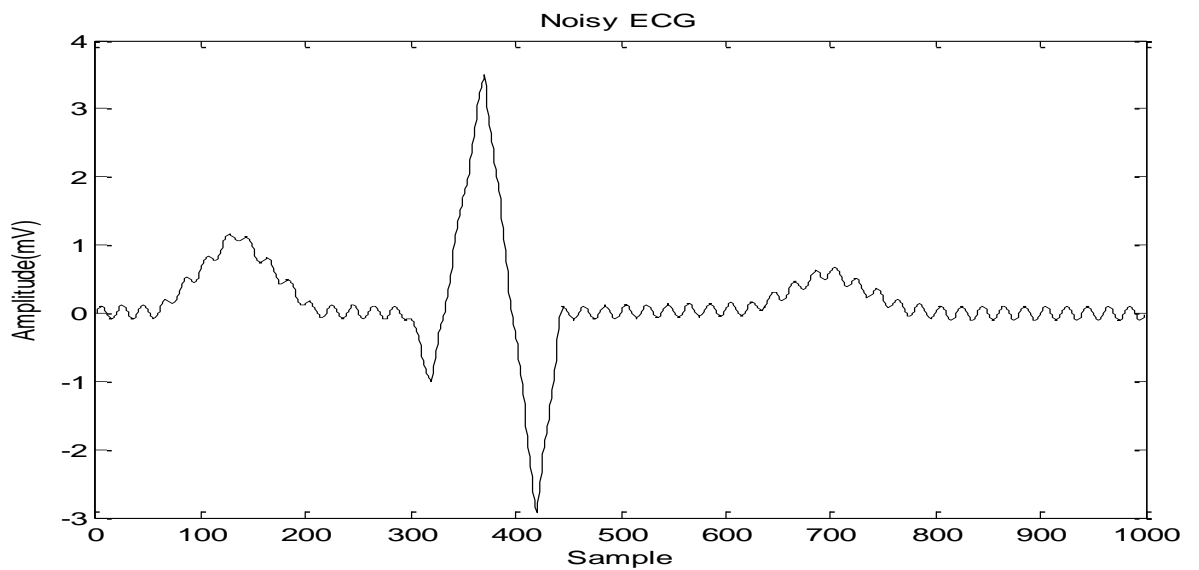

Figure 4.7: Noisy ECG

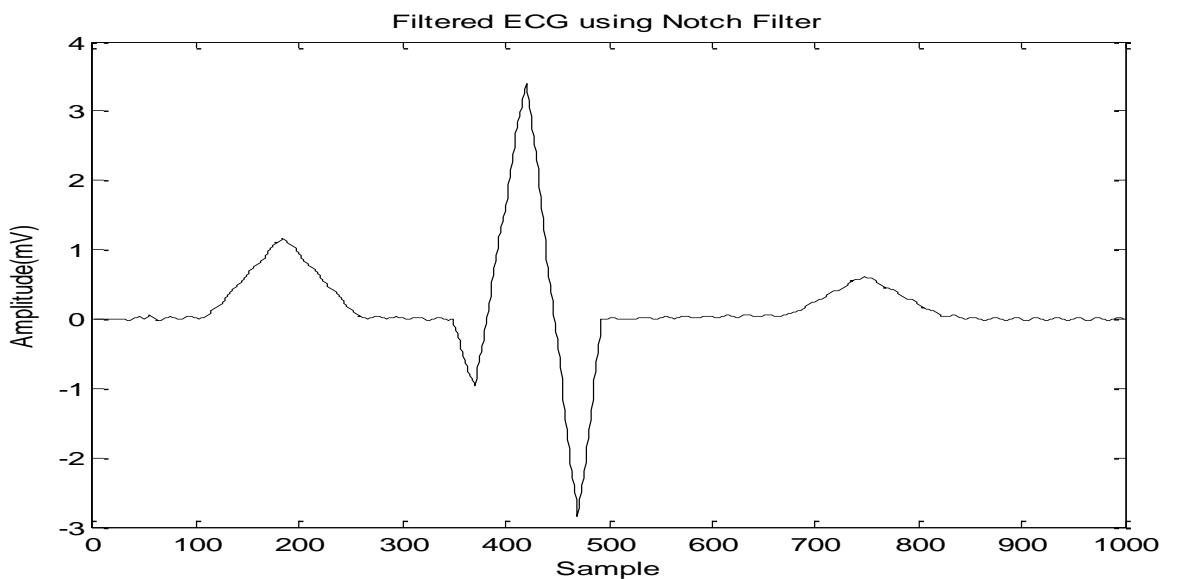

Figure 4.8: Notch Filter Output

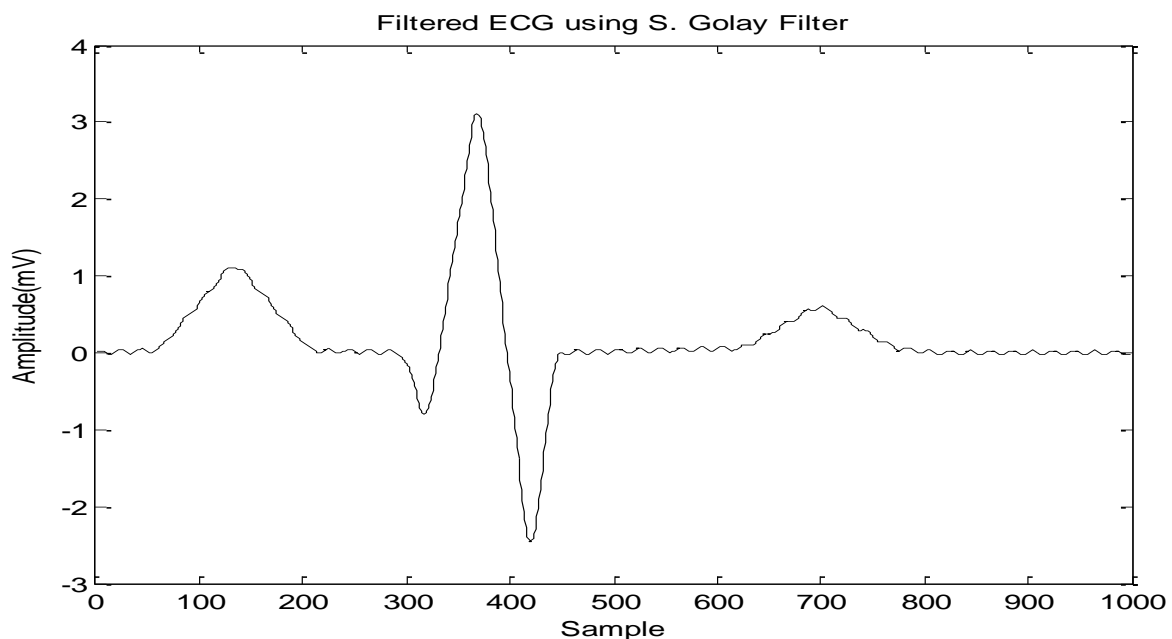

Figure 4.9: S. Golay Filter Output

Table 4.1: Comparison Table of Filters for AC interference

Filters	SNR Before Filtering(db)	SNR After Filtering(db)	MSE
Notch	20.03	23.60	0.0032
Savitzky-Golay	20.03	25.30	0.0021

4.3 Result of Filtering on Database

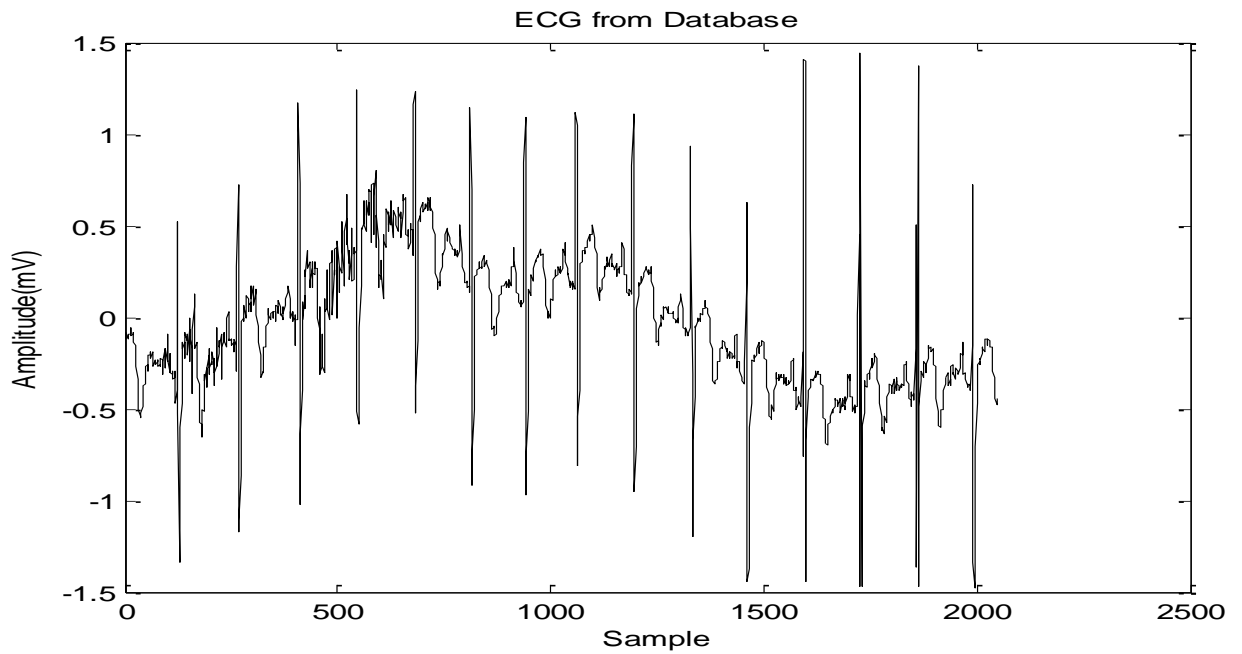

Figure 4.10: [12] ECG From Database

A. To Remove wandering base line

Using S. Golay Filter

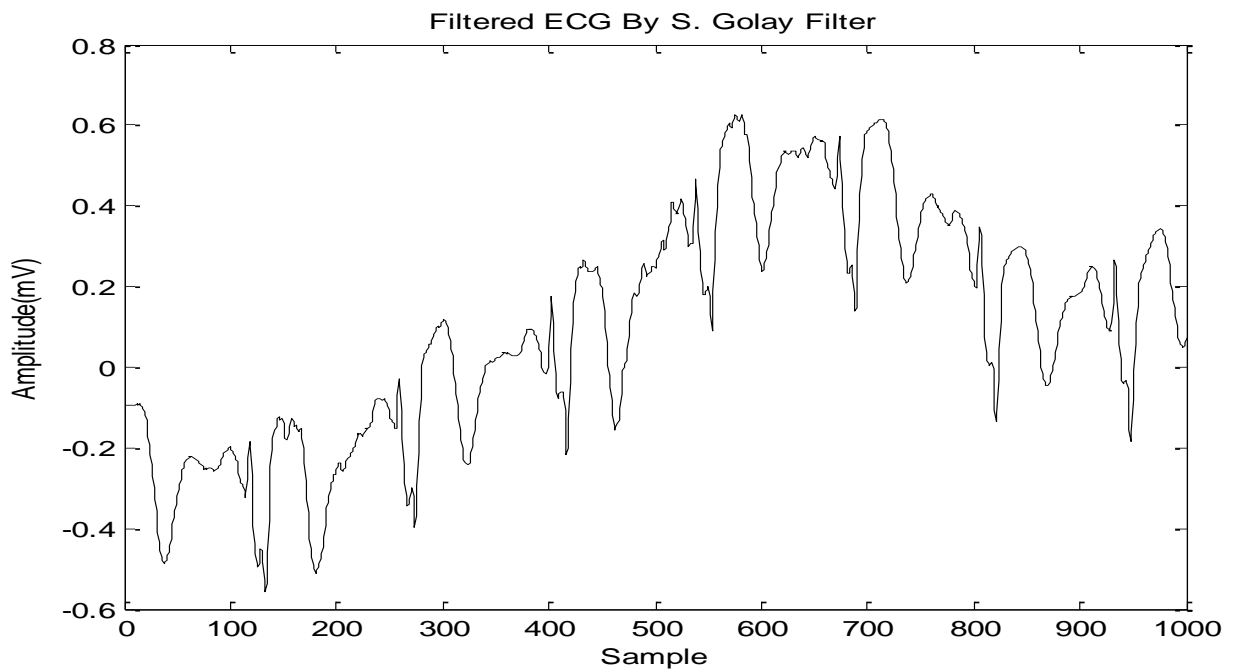

Figure 4.11: S. Golay Filter Output

Using Moving Average Filter

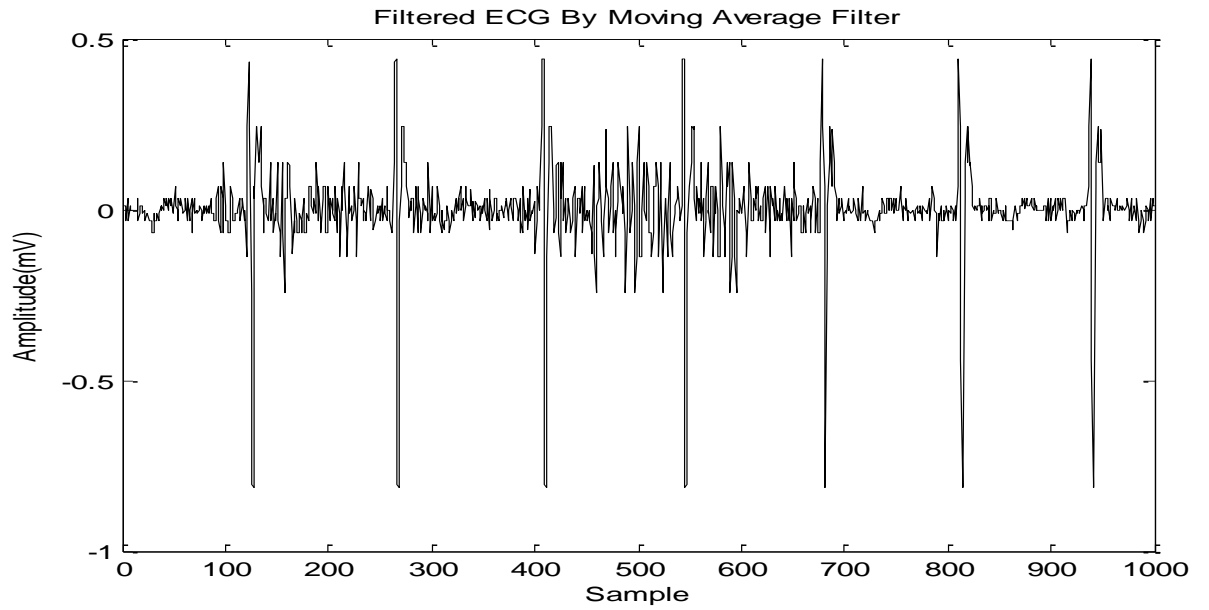

Figure 4.12: Moving Average Filter Output

B. To remove AC interference

Using Notch Filter

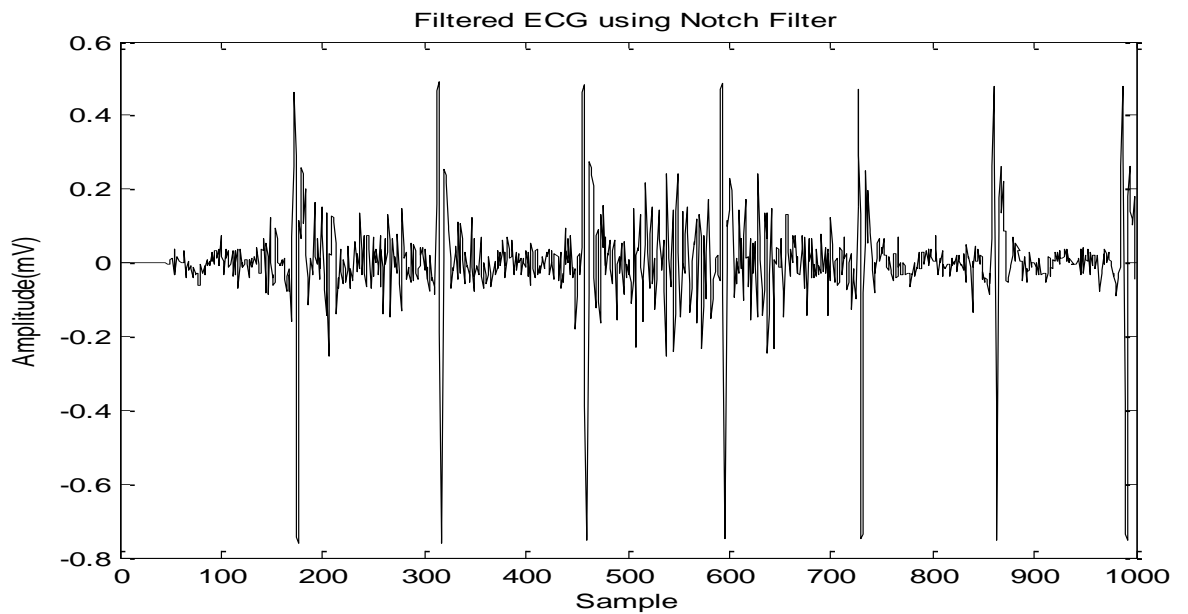

Figure 4.13: Notch Filter Output

Using S. Golay Filter

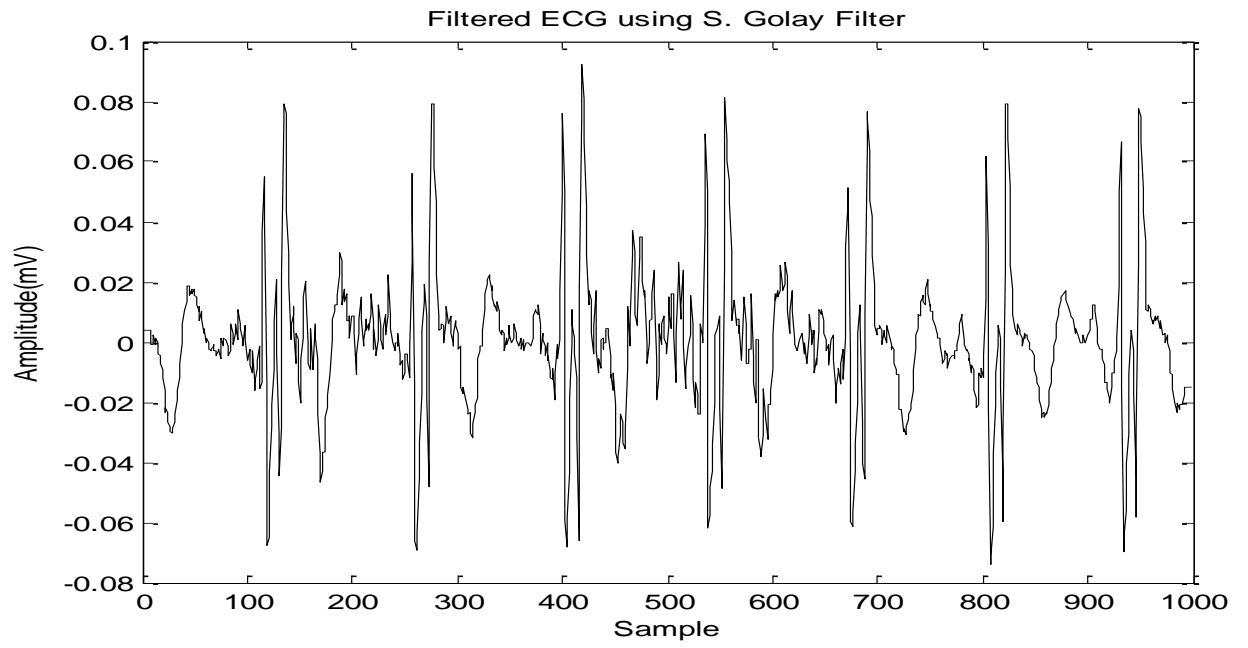

Figure 4.14: S. Golay Filter Output

```

butter1=filter(a,b,p); % Butterworth Filter

medfil1=medfilt1(p);

errfir=fir1-x; %error for FIR

msefir=mse(errfir)%MSE for FIR

snr_after = mean( x .^ 2 ) / mean( errfir .^ 2 ); %SNR for FIR

snr_afterfir_db = 10 * log10( snr_after ) %SNR IN DB FOR FIR

figure(3);

plot(1:length(fir1),fir1,'black'); %FIR Output

title('FIR output');

xlabel('sample');

ylabel('Amplitude(mV)');

errsg = sg1 - x; %error for SGOLAY

mmsg=mse(errsg) %MSE for SGolay

snr_after = mean( x .^ 2 ) / mean( errsg .^ 2 ); %SNR for SGolay

snr_after_db = 10 * log10( snr_after ) %SNR IN DB FOR SGolay

figure(4);

plot(1:length(x),sg1,'black'); %SGOLAY Output

title('S-Golay output');

xlabel('sample');

ylabel('Amplitude(mV)');

errbut = butter1 - x; %error for butterworth

msebut = mse(errbut) %MSE for butterworth

snr_after = mean( x .^ 2 ) / mean( errbut .^ 2 ); %SNR for butterworth

snr_after_db = 10 * log10( snr_after )%butterworth Output

```

```

figure(5);

plot(1:length(x),butter1,'black'); %butterworth Output

title('Butterworth output');

xlabel('sample');

ylabel('Amplitude(mV)');

errmedfil=medfil1-x; %error for median filter

msemedfil=mse(errmedfil) %MSE for median filter

snr_after = mean( x .^ 2 ) / mean( errmedfil .^ 2 ); %SNR for median filter

snr_after_db = 10 * log10( snr_after ) %SNR IN DB FOR median filter

figure(6);

plot(1:length(x),medfil1,'black'); %median filter Output

title('Median output');

xlabel('sample');

ylabel('Amplitude(mV)');

```

4.2 To remove AC Interference(Using In Built Function)

```

fs=1000;

f1=40;

f2=60; % sampling, lower and upper cutoff frequencies in Hz respectively;

w1=2*f1/fs; % computes normalized digital lower cutoff frequency;

w2=2*f2/fs ;% computes normalized digital upper cutoff frequency;

L=100; % order of the filter;

wn=[w1 w2]; % if the programmer desires to define the two cutoff frequencies
by one Symbol;

b=fir1(L,wn,'stop',hamming(L+1)); % creates the object of the notch filter

```

```

weighted with hamming window;

k=1:1000;

x1=0.1*sin(2*pi*50*(k-1)/fs); % sampled 0.1mV/ 50Hz

powerline noise;

x=3.5*ecg(1000); % sampled 3.5mV ecg signal;

d=x1+x; % contaminated ecg signal;

si=zeros(1,L); % initializes all filter taps to zero;

figure(1);

plot(x,'black');

title('Simulated ECG wave');

xlabel('Sample');

ylabel('Amplitude(mV)');

figure(2);

plot(d,'black');

title('Corrupted ECG wave with AC interference');

xlabel('Sample');

ylabel('Amplitude(mV)');

y=filter(b,1,d,si); % filters the ecg signal;

figure(3);

plot(k-1,y,'black') % plots the filtered ecg signal;

title('Filtered ECG wave using Notch Filter');

xlabel('Sample');

ylabel('Amplitude(mV)');

noise=d-x;

snr_before = mean( x .^ 2 ) / mean( noise .^ 2 );%SNR Calculation

```

```

snr_before_db = 10 * log10( snr_before ) % in dB

errnt = y - x;

msent=mse(errnt)

snr_after = mean( y .^ 2 ) / mean( errnt .^ 2 ); %SNR for SGolay
snr_after_db = 10 * log10( snr_after ) %SNR IN DB FOR SGolay

sg1 = sgolayfilt(d,0,15);

figure(6)

plot(k-1,sg1,'black');

title('Filtered ECG wave using S. Golay Filter');

xlabel('Sample');

ylabel('Amplitude(mV)');

errsg = sg1 - x;

msesg=mse(errsg)

snr_after = mean( sg1 .^ 2 ) / mean( errsg .^ 2 ); %SNR for SGolay
snr_after_db = 10 * log10( snr_after ) %SNR IN DB FOR SGolay

```

4.3 To remove AC Interference(Using Database ECG)

```

fs=1000;

f1=40;

f2=60; % sampling, lower and upper cutoff frequencies in Hz respectively;

w1=2*f1/fs; % computes normalized digital lower cutoff frequency;

w2=2*f2/fs ;% computes normalized digital upper cutoff frequency;

L=100; % order of the filter;

wn=[w1 w2]; % if the programmer desires to define the two cutoff frequencies
by one symbol;

```

```

b=fir1(L,wn,'stop',hamming(L+1)); % creates the object of the notch filter
weighted with hamming window;

k=1:1000;

ec=load('heart.dat');

figure(1);

plot(ec,'black');

title('Corrupted ECG');

xlabel('Sample');

ylabel('Amplitude(mV)');

for i = 1 : 1 : length(ec)

if i == 1

    m(i)=ec(i+1)-ec(i);

end

if i > 1

    m(i)= ec(i)-ec(i-1);

end

end

for i=1:1:1000

    d(i)=m(i);

end

figure(2);

plot(d,'black');

title('Filtered ECG');

xlabel('Sample');

ylabel('Amplitude(mV)');

```



```

si=zeros(1,L); % initializes all filter taps to zero;

y=filter(b,1,d,si); % filters the ecg signal;

figure(3);

plot(k-1,y,'black') % plots the filtered ecg signal;

title('Filterd ECG wave using Notch Filter');

xlabel('Sample');

ylabel('Amplitude(mV)');

noise=d-x;

snr_before = mean( x .^ 2 ) / mean( noise .^ 2 );%SNR Calculation

snr_before_db = 10 * log10( snr_before ) % in dB

errnt = y - x;

msent=mse(errnt)

snr_after = mean( y .^ 2 ) / mean( errnt .^ 2 ); %SNR for SGolay

snr_after_db = 10 * log10( snr_after ) %SNR IN DB FOR SGolay

sg1 = sgolayfilt(d,0,15);

figure(6)

plot(k-1,sg1,'black');

title('Filtered ECG wave using S. Golay Filter');

xlabel('Sample');

ylabel('Amplitude(mV)');

errsg = sg1 - x;

msesg=mse(errsg)

snr_after = mean( sg1 .^ 2 ) / mean( errsg .^ 2 ); %SNR for SGolay

snr_after_db = 10 * log10( snr_after ) %SNR IN DB FOR SGolay

```

4.4 To remove Wandering Baseline

```
ec=load('heart.dat');

figure(1);

plot(ec,'black');

title('Corrupted ECG');

xlabel('Sample');

ylabel('Amplitude(mV)');

for i = 1 : 1 : length(ec)

if i == 1

    m(i)=ec(i+1)-ec(i);

end

if i > 1

    m(i)= ec(i)-ec(i-1);

end

end

for i=1:1:1000

    x(i)=m(i);

end

figure(2);

plot(x,'black');

title('Filtered ECG');

xlabel('Sample');

ylabel('Amplitude(mV)');
```

Conclusion

- With all the attempts and previous researches we here want to make a point that filtering of noise from ECG signal is a difficult task and still not that much successful. The United States Preventive Services Task Force does not recommend electrocardiography for routine screening procedure in patients without symptoms and those at low risk for coronary heart disease. This is because an ECG may falsely indicate the existence of a problem, leading to misdiagnosis, the recommendation of invasive procedures, or overtreatment.
- Depending upon the types of noises there exist some techniques through which these noises can be avoided to some extent.
- As in real time data we don't know what is actual noise present in ECG wave so we are not able to calculate SNR and MSE. By just looking at the waveforms we can make some conclusions.
- On real time data For baseline wandering we pass it through two filters. First S. Goly because it is doing well in most of the noises but here it didn't work. Secondly we applied moving average filter which actually performed well.
- For AC interference again we applied S. Goly and Notch filter. But from the graph it looks S. Goly is doing well.
- From all the comparison Tables and graphs we conclude that Savitzky-Golay filter is the best filter for AWGN and AC interference noises.
- And whereas Moving Average Filter is the best filter for the wandering baseline.

REFERENCES

- [1] Jain, Rituraj. "12 Lead ECG Data Compression Using Principal Component Analysis." *International Journal of Emerging Trends & Technology in Computer Science (IJETTCS)* Volume 4, Issue 1, January-February 2015, pp 34-39.
- [2] Deshpande, Seema, and S. O. Rajankar. "ECG data compression using principal component analysis." *International Journal of Electrical, Electronics and Computer Systems*, Volume 1, Issue 2, 2013 pp 13-16.
- [3] Sawant, Chitrangi, and Harishchandra T. Patii. "Wavelet based ECG signal de-noising." 2014 IEEE First International Conference in Networks & Soft Computing (ICNSC), August 19 2014, pp 20-24.
- [4] Chandrakar, Bhumika, O. P. Yadav, and V. K. Chandra. "A Survey of noise removal Techniques for ECG Signals." *International Journal of Advanced Research in Computer and Communication Engineering*, Volume 2, Issue 3, March 2013, pp 1354-1357.
- [5] Muralidhar, P. V., S. K. Nayak, and PVS Nirosha Devi. "S/N-ECG SIGNAL WITH HYBRID WINDOW TECHNIQUE." *International Journal of Science, Engineering and Technology*, Volume 1, Issue 4, 2012, pp 1-6.
- [6] Smital, Lukas, et al. "Adaptive wavelet wiener filtering of ECG signals." *IEEE Transactions on Biomedical Engineering*, Volume 60, Number 2, February 2013, pp. 437-445.
- [7] Kroft, L. J. M., A. De Roos, and J. Geleijns. "Artifacts in ECG-synchronized MDCT coronary Angiography." *American Journal of Roentgenology*, Volume 189, Issue 3, 2007 pp 581-591.
- [8] Vidya, M. J., and ShruthiSadasiv. "A Comparative Study on Removal of Noise in ECG Signal Using Different Filters." *International Journal of Innovative Research and Development*, Volume 2, Issue 4, April 2013, pp 915-927.
- [9] Hu, Xiao, Zhong Xiao, and Ni Zhang. "Removal of baseline wander from ECG signal based on a statistical weighted moving average filter." *Journal of Zhejiang University SCIENCE C* 12.5 (2011): 397-403.
- [10] Patil Harishchandra T., and Raghunath Sambhaji Holambe. "New approach of threshold estimation for denoising ECG signal using wavelet transform." In *India Conference (INDICON)*, 2013 Annual IEEE. IEEE, 2013 pp 1-4.

[11] Paul, Dr, and Sanjoy Kumar. "Determination of exponential smoothing constant to minimize mean square error and mean absolute deviation."Global Journal of Researches In Engineering ,Volume 11, Issue 3 , 2011 pp 30-34.

[12]For ECG Database "MIT-BIHArrhythmia Database".

<http://www.physionet.org/cgi-bin/atm/ATM>