

SMART AGRICULTURE SYSTEM USING IOT

Project Report Submitted to the Partial Fulfillment of the Requirement for the
degree of Bachelor of Technology

In

Computer Science and Engineering

By

Ajay Kumar (161309)

Under the supervision of

Dr. Jagpreet Sidhu

to



Department of Computer Science & Engineering and Information Technology

Jaypee University of Information Technology Waknaghat, Solan-173234,

Himachal Pradesh

Candidate's Declaration

I hereby declare that the work presented in this report entitled **SMART AGRICULTURE SYSTEM USING IOT** in partial fulfillment of the requirements for the award of the degree of **Bachelor of Technology in Computer Science and Engineering** submitted in the department of Computer Science & Engineering and Information Technology, Jaypee University of Information Technology, Waknaghat is an authentic record of my own work carried out over a period from January 2020 to May 2020 under the supervision of **Dr. Jagpreet Sidhu**, Assistant Professor (Senior Grade), Computer Science Engineering and Information Technology.

The matter embodied in the report has not been submitted for the award of any other degree or diploma.



Ajay Kumar (161309)

This is to certify that the above statement made by the candidate is true to the best of my knowledge.



Dr. Jagpreet Sidhu

Assistant Professor (Senior Grade)

Computer Science & Engineering and Information Technology

Dated:

25/05/2020

ACKNOWLEDGEMENT

I have made efforts in this project. However, it would not have been possible without the help and kind support of many Organizations and Individuals. I would like to give my sincere thanks to all of them.

I am highly thankful to “**Dr. Jagpreet Sidhu**” for his constant supervision and guidance as well as for providing me necessary information in context of this project and also for his support in completing the project.

I would like to express my gratitude towards Jaypee University of Information Technology and also my Parents and Teachers for their kind encouragement and co-operation which helped me in completion of the project.

My appreciation and thanks also goes to my colleagues in developing the project and people who have helped me out with their abilities in making this project a successful project.

DETAILED PROJECT REPORT STRUCTURE

CERTIFICATE.....	i
ACKNOWLEDGEMENT.....	ii
LIST OF FIGURES.....	iv-v
LIST OF TABLES.....	vi
ABSTRACT.....	vii
1. Chapter-1 INTRODUCTION	
1.1. Introduction.....	9-16
1.2. Problem Statement.....	14
1.3. Objectives.....	15
1.4. Methodology.....	16
2. Chapter-2 LITERATURE SURVEY.....	17-20
3. Chapter-3 SYSTEM DEVELOPMENT.....	21-38
3.1. System System Circuit Design.....	26
3.2. Algorithm.....	27
3.3. Analytical.....	28-34
3.4. Computational.....	35
3.5. Experimental.....	36-38
4. Chapter-4 PERFORMANCE ANALYSIS.....	39-48
5. Chapter-5 CONCLUSIONS	
5.1. Conclusions.....	49
5.2. Future Scope.....	50
REFERENCES.....	51-52

List of Figures:

FIG.	TITLE
FIG. 1	Overview of IOT
FIG. 2	A Farming Land
FIG. 3	Food Trade Evolution
FIG. 4	Smart Farm based on IoT
FIG. 5	Methods in Designed System
FIG. 6	Wiring in Breadboard
FIG. 7	Buzzer Module
FIG. 8	Area Under PIR sensor
FIG. 9	System Circuit Design
FIG. 10	Screenshot of Website Application
FIG. 11	PIR Motion Sensor
FIG. 12	Soil Moisture Sensor
FIG. 13	Temperature-Humidity Sensor (DHT11)
FIG. 14	PH Sensor
FIG. 15	ARDUINO
FIG. 16	Sketch Arduino
FIG. 17	Python
FIG. 18	PHP
FIG. 19	MySQL
FIG. 20	Complete Data Flow Diagram
FIG. 21	Conformal Coating
FIG. 22	Arduino Output – 1
FIG. 23	Arduino Output – 2
FIG. 24	Farm Database – 1
FIG. 25	Farm Database – 2
FIG. 26	Farm Database – 3
FIG. 27	Python Output – 1
FIG. 28	Python Output – 2
FIG. 29	Readings – 1 Website Application
FIG. 30	Readings – 2 Website Application
FIG. 31	Readings – 3 Website Application

FIG. 32	Readings – 1 Website Application (Responsive)
FIG. 33	Readings – 1 Website Application (Responsive)
FIG. 34	(SIS)(SIS)Smart Irrigation System

List OF Tables:

FIG.	Title
a.	Contribution Chart GDP
b.	Various Technologies used
c.	Soil Properties for the Rice Crop
d.	Soil Properties for the Apple Crop
e.	Data Sample from the Sensors
f.	Result from the Sensors
g.	Parameter of Soil Moisture Sensor
h.	Parameter of Temperature- Humidity Sensor (DHT11)
i.	Performance Parameter of PIR Sensor
j.	Performance Parameter of PH Sensor

ABSTRACT

Agribusiness assumes a crucial job in the advancement of a rural nation. In India, nearly Seventy % of the total population relies on cultivation and about 33% of the India's total capital comes from cultivation. Issues concerning agriculture is consistently preventing the improvement of country. Most logical answer on this issue is shrewd agribusiness, by implementing the current customary techniques for agribusiness. Thus the task targets making horticulture brilliant utilizing IoT and robotization advancements. The featuring highlights of this undertaking incorporate the better practice of pesticides utilized in ranches and counteracting soil disintegration subsequently bringing about more noteworthy yields. Also, it highlights a shrewd water management system with proper control and insightful basic observation dependent on precise ongoing field information. Thirdly, keep up the details about soil like by inspecting different parameters of soil as clamminess, temperature enhancements. Lastly, by keeping crops are being affected by mammals from interruption acknowledgment techniques using Passive Infrared Sensors. All these capacities will be managed by any remote sharp instrument or PC joined with the Internet and the undertakings will be finished by executing Arduino, sensors, Raspberry pi and control Supply.

Chapter-1

Smart Agriculture System Using IOT: Introduction

1.1 Introduction

Internet of Things (IoT) is a fine arrangement of gadgets, for ex, electrical machines, physical gadgets, and various things inbuilt with actuators and sensors which enables the articles to develop a relationship with different structures within this manner exchanges data from devices. Everything is totally perceived through its different embedded handling and it works as the present structure of the Internet.

IoT detected the things and remotely constrained by getting across over a current establishment of the framework, making progressively open gateway for an alternate of this current reality into the PC based structures, and results in improved precision, budgetary focal points, and profitability to human considerations. Exactly when the development is performed with the sensors and actuators, it envelops motorization in various fields, for instance, astute force plants, sharp transportation, adroit homes, splendid systems, and sharp urban networks.

Applications:

Internet related devices and applications are expansive. Lot of orders has been suggested, by far most of them are as follows:

1. Infrastructure Management: Environmental Monitoring, Manufacturing Agriculture, Energy Management, Metropolitan Scale Developments, Building, and Home Automation.
2. Consumer Based: Home Automation
3. Enterprise: Media
4. Other fields: Medical, Health Care and Transportation.

Each farm needs the application on IoT taking into account the ability to sort out embedded devices with obliged resources. Each and every such structure accumulates data and information from a typical organic framework in recognizing the degree and finds suitable applications in the need of urban organizing and common identifying.



FIG. 1 Overview of Internet of Things

Agriculture:

Agribusiness is that action which principally includes the development of plant and creature items that help in continuing human life. Horticulture goes back to a huge number of years, and from that point forward it has been created, as it were, by different societies, atmospheres and methods. Subsequently, agribusiness has changed a great deal.

Agribusiness representatives the most noteworthy number of individuals all through, around 33% of the working populace is occupied with farming and additionally related exercises, the administration part pursues. Be that as it may, the level of individuals engaged with horticultural has been diminishing over the previous hundreds of years.



FIG. 2 A Farming Land

Future of Indian Agriculture:

The huge populace of the Country's agribusiness must work with information and by and large magnificent quality advances which will maximize yields and which will return the lost confidence of individuals in horticulture. By self-rule, the level of Gross Domestic Product which has diminished from 1/2 to 1/5. Regardless, Agribusiness now also incredibly adds to the compensation the supply of unpleasant materials to different sellers who are chipping away at it. To fulfill the necessity for food supplies of a broadening people which is relied on to stretch out around 1.6 billion by 2050, mechanical refinement and progress in development is phenomenally crucial and required by the nation. [1]

In India, Departments like-biotechnology is preparing for better yields and quality. As we can see India has created cultivating from the ongoing 25 years now, the activity of the agribusiness data industry had been critical. The open Research & Development, seed gracefully have completed their basic duty to the non-consumable and consumable yield creation.

Government of India is working with some big agri-business associations to fulfill the necessities and requirements of people involved in farming from harvesting to planting.

Agribusiness is Primary and Major Sector of the Indian Economy. It uses standard resources. A huge segment of the endeavors also rely on the cultivating portion for their crude materials. The orchestrated method to manage this progression has helped the nation to show up at the country's stage where it is autonomous in sustenance crops and has pleasant stock. These achievements have been possible basically through the fundamental and perfect technique structure. The objective of Country's Agri-business is to achieve sustenance security by giving a propelling power to advancement close by fair access to sustenance. In this manner, terrible starvations have become events of the past and the plant age doesn't show huge assortment even on account of adversarial climatic state of nation.

a. Contribution Chart GDP

Industry	2010-11	2011-12	Growth	Weightage	
Agriculture, forestry & Fishing	709103	728667	2.76%	14.01%	14%
Mining and Quarrying	109421	108469	-0.87%	2.08%	19%
Manufacturing	774162	793468	2.49%	15.25%	
Electricity, Gas and Water Supply	90944	98105	7.87%	1.89%	67%
Construction	384199	404617	5.31%	7.78%	
Trade, Hotels, Transport & Communication	1330455	1462772	9.95%	28.12%	
Financial, Insurance, Real Estate & Business	849995	931714	9.61%	17.91%	
Community, Social & Personal Services	637675	674703	5.81%	12.97%	
Total	4885954	5202515	6.48%	100.00%	100.00%

Because the number of changes presented in the mid of 90s, the general exchange stream of India expanded altogether. India is the biggest exchanging accomplice representing 1.8% of the all out of which is represented about €2 billion. Though the farming and nourishment items have a little rebate in the general Indian exchange and their fares represent just nine% of overall fares and five% of overall imports.

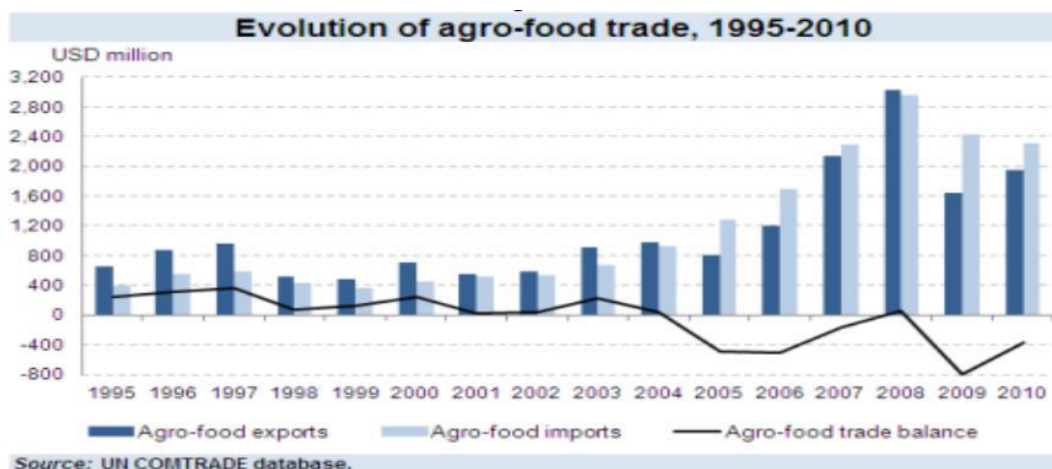

FIG. 3 Food Trade Evolution

Green change was a basic change in development and same fields. Hence, creative work has helped us accomplish in minimizing food cost, a predominant food report, improved agrarian tolls and in general binds like exchange.

Agriculture Society of England, set up during 1790s in UK, masterminded headway of exploratory turn of developments. Correspondingly, in United States, the Agriculture Department was developed. These affiliations helped in setting up the systems which were utilized in creating.

Our Nation encountered a relative colossal uprising by the development of Agriculture Department in India's local in 1880 which was the time when British principal has been predominant in the country. At the point when the nation got autonomy, again the essential worry of the pioneers of those occasions was innovative work in horticulture as it was one of the essential business of the country during those occasions a council was set up which rolled out substantial improvements in the board, of the examination task in the nation.

The complete evaluation habitats were known under single focal name, (ICAR) Indian Council of Agricultural Research and if we look at state level the examination and getting ready moved to (SAUs) State Agricultural Universities. These endeavors helped in the improvement of the development part and motivated to be a key division in supporting entire work extent of the affiliation also to the nation's economy.

1.2 Problem Statement

This is the project from the motivation of the farmers working in the fields and are totally dependent on the rains and bore wells for irrigation of their cultivable land. In recent times, the Farmers have been utilizing water system procedures through the manual control in which the farmers irrigate the land at regular intervals by switching the water-pump **off/on** when required. Moreover, for the power indication they are glowing a single bulb between any one of phase, meanwhile when there is any power shortage occurs in other phases, the farmer cannot know that their water supply to the crop is low. If they Switch ON any of the motor, there will be the sudden power defuse in motor circuit. They may need to travel so far for switching ON/OFF the engine. They may have to suffer from hot Sun, rain and in dark night time too. After reaching their farm, they found that there is no power, so they quietly disappointed to it!! Also every crop needs different amount of water and moisture to grow properly for maximum yields. Also there are limited amount of workers to cover a large area of land. Limited by time. How the farmer will know the optimum environment in terms of moisture and temperature. Is there any solution for it???

1.3 Objectives

To Overcome the limitations of the irrigation system in conventional farming. To provide and maintain the crops an optimum environment for maximum growth. The objective of this designed system is to extend the standard of the economy of country. Cultivating play a significant and critical activity in the improvement of an agribusiness titled country. In India, we have more or less **seventy%** of the populace relies completely upon the development and related exercises and **thirty-three%** of the country's capital originates from it. Problems concerning farming have reliably impeded the advancement of the nation to a great extent or the other. One way out to this issue is brilliant agribusiness, for example by blending the current conventional rural strategies with a bit of present-day agriculture. Thus, the task targets making horticulture simple and bother free utilizing brilliant automation procedures using IOT advancements as its successors. The featuring highlights of this venture incorporate the better practice of pesticides utilized in ranches and forestalling soil disintegration subsequently bringing about more noteworthy yields. Also, it fuses a customized water framework with appropriate control and keen fundamental administration reliant on precise continuous field data. Thirdly, keep up the idea about soil by inspecting various parameters of soil like dampness, temperature and supplement content. Lastly, shielding crop from being damaged by homeless animals coming from assault area framework using PIR Sensor deployed on required separation over the complete fringe of the homestead. These all undertakings should be managed through a wireless contraption or PC related with the Internet and the exercises would be performed by Arduino, Raspberry pi, interfacing sensors, electrical devices, control flexibly.



FIG. 4 Smart Farm Based on IoT

1.4 Methodology

The methodology got a handle on in the defined structure is that, it contains assorted Arduino sheets according to the requirements and an assembled at a PC, the Raspberry. The pi is moreover organized with a joined server that goes about as an intersection purpose of data exchange among pi and the client (the farmers). Different notice with respect to low wetness, manure essential and attack will be given to the farmer who is using the system through an application stage. The Application has 2 fundamental procedures for working, first is that procedure in which the client will pick when to apply on the machines relying on the states of the farmer as point by point by the application from the bits of information beginning from the property, or land by techniques for the sensors. Another procedure which we basically call as robotization mode whereas the client just picks the data which he has collected just now and then the application finds a choice whether it is going to perform off/on the motor to supply water. This system is an outstanding help for farmers and will have the alternative to spare some effort for their open activities and still have progressively prominent and perfect yields.

The Arduino Uno is connected with different sorts of sensors that sends there output for managing Arduino. The sensor passed on for this framework are soil dampness sensor, pH sensor, electrochemical sensor, moisture-temperature sensor and PIR Sensor.

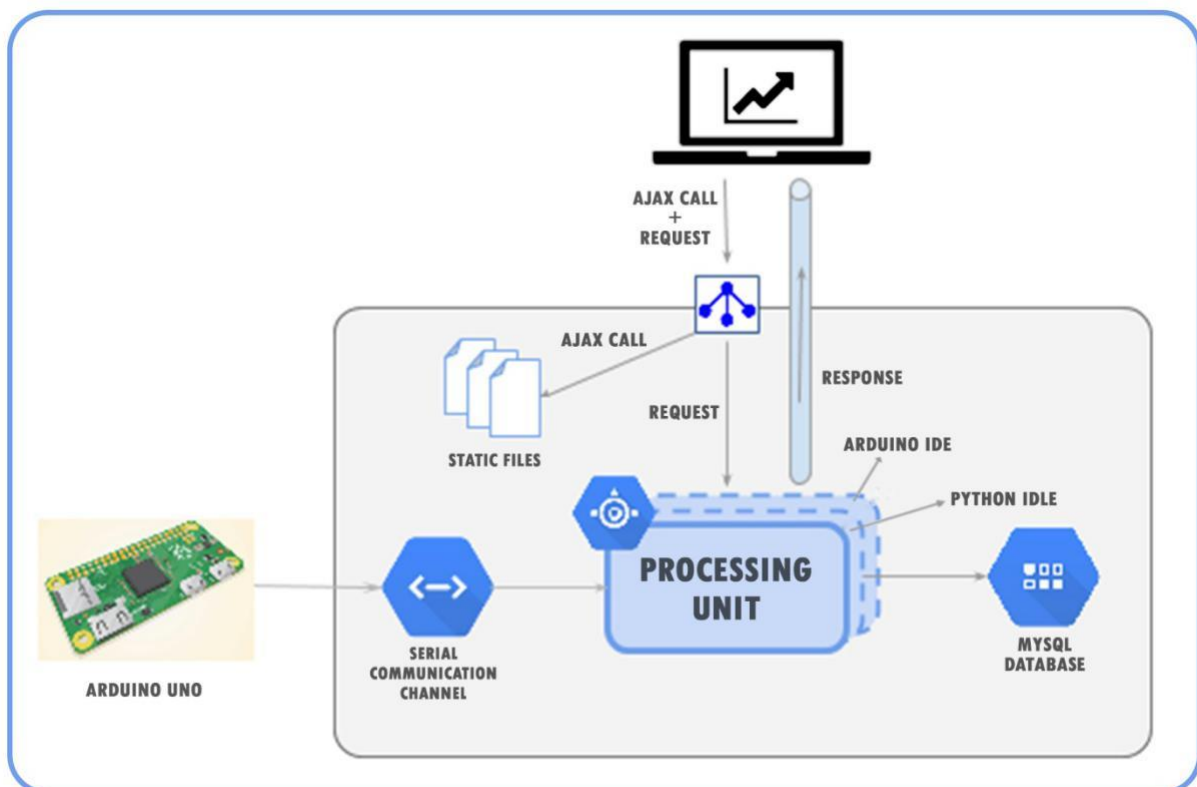

FIG. 5 Methods in Designed System

Chapter-2

LITERATURE SURVEY

1. INTERNET OF THINGS BASED EXPERT SYSTEM FOR SMART AGRICULTURE

Summary: Smart Farming System is proposed in this paper which will utilize thought of IoT, WSN, and appropriated handling to assist rancher with engineering a water structure plan for his domain. Real masterminding of water structure and

arranging is vital for appropriate improvement of yields. (Raheela Shahzadi et al. [10], 2016)

Advantages:

This paper brings information from the field and after assessment gives a water system time to the rancher.

Disadvantages:

A great deal of research work and information hoarding should be done to understand the past climate states of the specific locale and in this manner each time the structure should be changed for each rancher that lives in faraway spaces.

2. IOT BASED APPROACH FOR SMART AGRICULTURE

Overview: The structure was made using TelosB, Wi-Fi Gateway, RFID and Sensors and all the system is sifted through by making a proper network and offer information to the server using web affiliations.

This structure is proposed to for Soil Parameters - temperature, electrical conductivity, dampness and Soil supplements - Phosphorous (P), Nitrogen (N), Spectral reflectance for plant supplements and Potassium (K), (A. Paventhan, 2016)

Advantages:

Properties of Soil and its improvements are reasonably instructed on the website applications. Backing for field strategies and viewing.

Real solicitation and control focus are there to monitor all parameter reasonably.

Disadvantages:

Difficult structure not a nice decision for the Farmers.

Burdens of structure is its huge cost development.

3. SOIL NUTRIENT IDENTIFICATION

Summary: In this, the basic spotlight is on the soil supplements. As the estimation of soil supplements is massively needed for plants improvement to be fitting and persuading treatment. The basic soil supplements needed for the plant improvement are Nitrogen, Potassium, and Phosphorus. All improvements can be checked by utilizing an electro-chemical sensor. (R. Sindhuja et, 2017)

Advantages:

Lively affirmation of soil supplements.
Fitting course of action and water structure for genuine plant progression.

Disadvantages:

Brisk acknowledgment of soil supplements.
Fitting arrangement and water framework for real plant advancement

4.. SECURITY BASED ON PASIVE INFRARED SENSOR

Overview: This report, a basic security framework dependent on the Passive Infrared sensor is organized which switched on the cam whenever it detects a gatecrasher in the exposure degree of the Passive Infrared PIR Sensor. The structure gets the live recording of video utilizing cam additional items control when lighting structure can be diminished around evening. (Pema Chodon et , 2013)

Advantages:

The decrease of intensity ate up by brightning structure around the evening time.
Additional items memory of the accounting structure as the chronicle begins precisely when the webcam is on.

Disadvantages:

The structure isn't valuable for interloper entering from some other side.

5.LOW COST SOLUTION FOR HUMIDITY AND TEMPERATURE MONITORING.

Overview: This report states, the structure for humidity and determination control screen utilizing the Lcd show is created. There is amassed utilizing AVR ATmega16 Microcontroller and DHT11 is utilized to sense the temperature and industriousness. (Ashish Sharma et , 2013)

Advantages:

Progressively linearity and critical endurance with the entirety of the sensors.
Straightforwardness answer for industriousness screen and temperature utilizing contact screen progression.

Disadvantage: Remotely accessibility for the dampness and temperature viewing isn't there in the structure.

6. SMART IRRIGATION CONTROL SYSTEM

Overview: This report states that, the structure for an unbelievable water system is made utilizing the water level and an earth clamminess sensor should check by utilizing a water sensor. The calendars for the water system can be solved and additionally remotely obliged by utilizing the Gsm Module. (Deepak Kumar Roy et, 2013)

Advantages:

Wastage of Water decreased utilizing astute water system control headway.

The control for the sharp water structure is remote with or without the physical closeness in the field.

Disadvantages:

Structure for a sharp water structure framework is staggeringly radiant.

2.1 Various Technologies used

Year Published	Title	Author (s)	Technology Used
2013	“Passive Infrared (PIR) Sensor Based Security System”	Pema Chodon et al. ^[22]	PIR Sensor, Webcam
2013	“Internet Of Things Based Approach To Agriculture Monitoring”	A. Paventhan ^[11]	TelosB, IRIS, AVR Raven, Sensors, Router, RFID
2014	“Smart Irrigation Control System”	Deepak Kumar Roy ^[24]	Water Level Sensor, GSM Controller and Soil Moisture Sensor
2016	“Low cost Solution for Temperature and Humidity monitoring and control System using Touch Screen Technology”	Ashish Sharma et al. ^[23]	DHT11, Touch Screen, AVR ATmega16 Microcontroller
2016	“IOT Based Smart Agriculture”	Nikesh Gondchawar et al. ^[8]	Camera and actuators with micro-controller and raspberry-pi, ZigBee or Wi-fi modules
2016	“IOT Based Smart Agriculture Research Opportunities And Challenges”	Aditi Mehta et al. ^[7]	RFID, ZigBee Modules, Raspberry Pi, Sensors
2016	“Internet Of Things Based Expert System For Smart Agriculture”	Raheela Shahzadi et al. ^[10]	IOT and Cloud computing
2017	“IOT Based Smart Agriculture Monitoring”	N. Suma et al. ^[6]	PIC16F877A- MICROCONTROLLER, GSM Module, Sensors
2017	“IOT Based Smart Farming System”	Akshay Atole et al. ^[9]	Cloud computing and Wireless Sensor network
2017	“Soil Nutrient Identification Using Arduino”	R.Sindhuja et al. ^[21]	Electrochemical Sensor and Arduino Microcontroller

Chapter-3

SYSTEM DEVELOPMENT

3.1 System System Circuit Design

Breadboard:

It is an instrument for a concise model with gear plans. Maximum electronic areas in electronic circuits can be interlinked by their terminals or leads into the gaps and sometime later creation connections through wires were legitimate. IT is made up of bits of the board and interfaces the openings on the most important purpose behind the board. The strips made up of metal are spread out as displayed as follows.

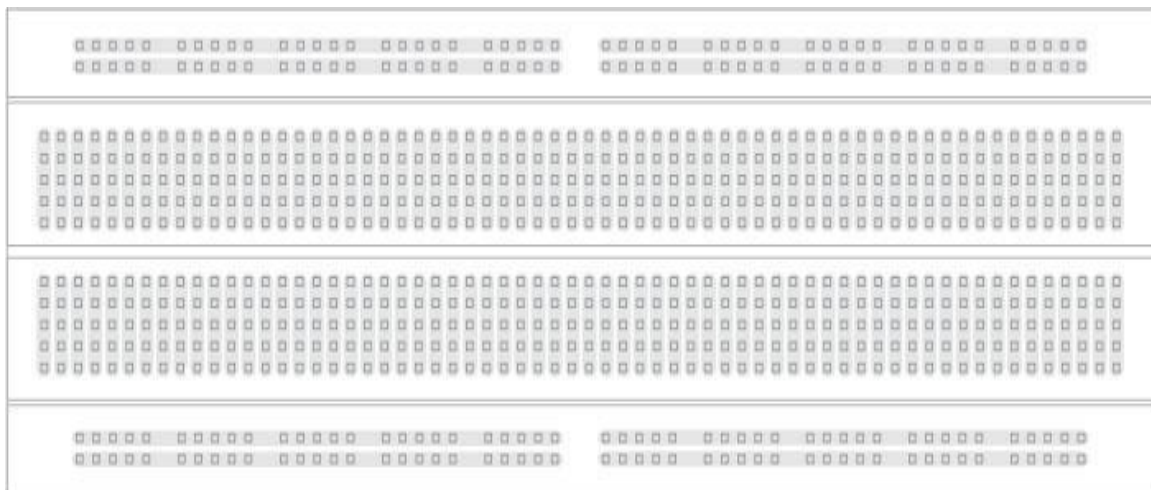

FIG. 5 Breadboard Wiring

Soil Moisture Sensor:

Soil Moisture Sensor has three pins: 1st is for grounding, the 2nd is vcc for voltage input and the 3rd is for straight forward information. Grounding stick and Voltage stick is related to the individual grounding and vcc sticks. Moistness level is then checked by the sensor in volumetric %. The data regard by the sensor is basic and is related to the A0 input stick on Arduino Board. The straightforward commitment by the sensor is needed to plot 00 to 100 since moistness examining is evaluated in rate.

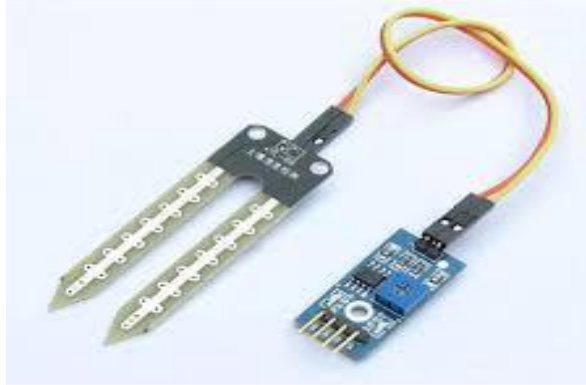

FIG.12 Soil Moisture Sensor

Humidity & Temperature Sensor (DHT11):

This sensor has 3 pins: 1st is for grounding, the 2nd one is Vcc for voltage and the 3rd one is for straightforward data. Grounding stick and Voltage stick connected with the diverse grounding and vcc stick in Arduino. Two key units are present there first is for assessing soaked quality and the other for perceiving temperature which is fundamentally a thermistor. Moisture is accessed by preparing the conductivity of a fluid substrate which change on changes in tenacity. The temperature is assessed utilizing a thermometer called thermistor. Here Temperature and steadiness examinations utilizing clear duty by interfacing the information stick of the sensor with AI stick on Arduino.



FIG.13. Humidity & Temperature Sensor

Digital Buzzer Module:

It is only an immediate stable creation module on **Low/High** to make noise. On essentially changing the rehash for the ringer the buzz sound makes. Stick 3 is connected to the Arduino Uno. Ringer sound can pass on by essentially making HIGH/LOW to the sensor. In this undertaking, HIGH/LOW s beginnings making when deterrent enters the seeing degree of the Passive Infrared at the exit of hindrance and makes interference.

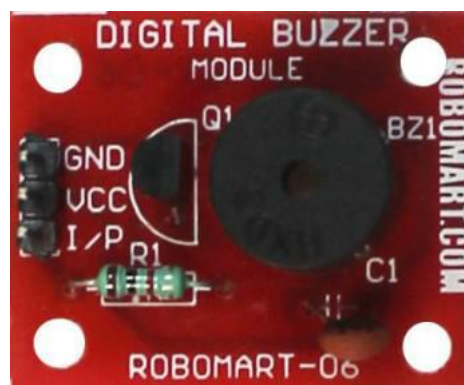

FIG.7 Buzzer Module

Remote Water Tank Level Monitoring Sensor:

IoT Agriculture Sensors can detect water in Tank levels and Leakage in order to implement better usage and to avoid unforeseen downfalls. Accurate and reliable information through alerts can help farmers save their time and also save labour cost.



FIG.. Water Level Monitoring Sensor



FIG.. Remote Water Tank Level Monitoring

PIR Sensor:

The PIR is used for motion detection which is much better than the IR sensor as IR sensor senses the Infrared radiation by emitting an IR radiation and waiting for it to be re-bounced by some obstacle and hence it is able to recognize a motion. The PIR sensor does not radiate IR beams of its own instead they detect IR beams radiated from warm bodies and has two detectors if there is a blockage of IR on the first one and also on the second one only then the PIR sensor detects a motion.

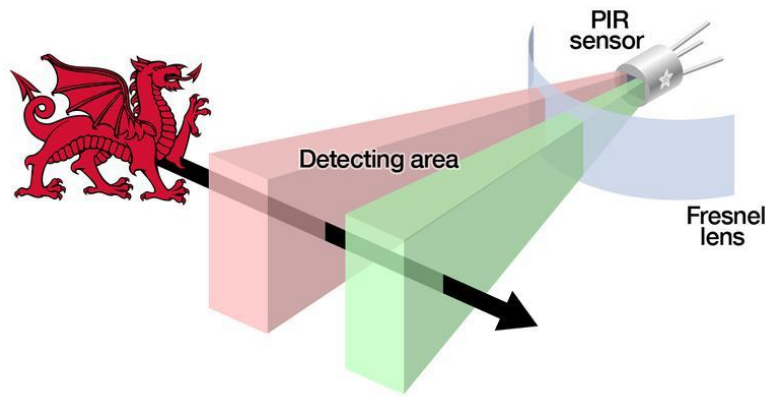

FIG.8 Area under PIR Sensor

It has 3 pins: first for establishing, 2nd is to input the voltage and the 3rd for straight forward information. Establishing stick and Voltage stick is related with the different establishing and Vcc stick in Arduino. The commitment for this sensor is progressed. The sensor is related with stick 8 at cutting edge data side on Arduino board. This Sensor doesn't transmit IR light discharges rather they distinguish IR shafts transmitted from authentic individuals and has two discoverers that if their is obstacle of IR on the first and besides on the 2nd precisely by then the Passive infrared sensor faculties and recognizes a development.

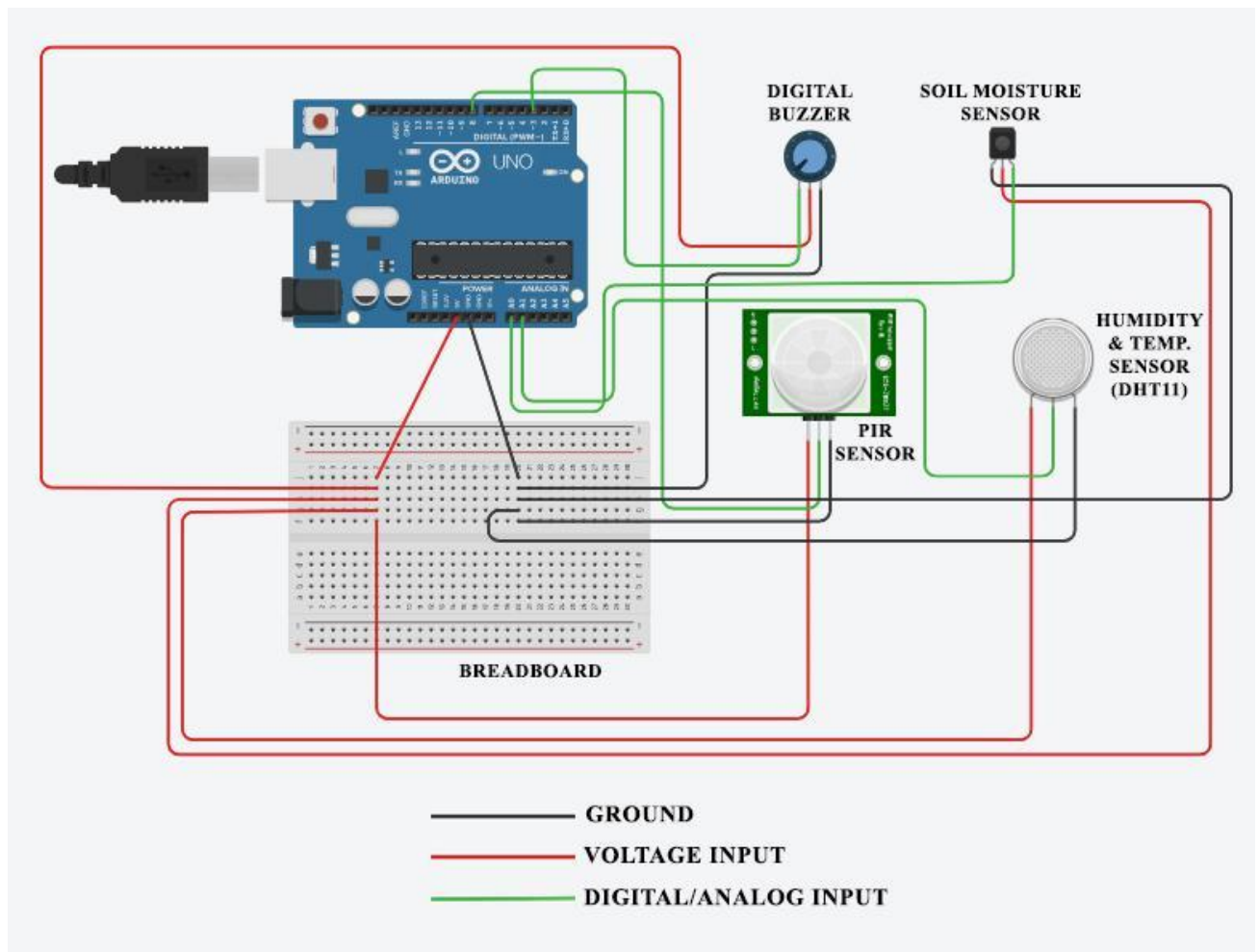

FIG. 9 System Circuit Design

3.2 ALGORITHM

```
//Arduino Pseudo Code
//Read Sensors Data
//1. Soil Moisture Sensor
Moisture = analogRead (sensor_pin)
//2. Temperature-Humidity Sensor (DHT11)
DHT.read11 (dht_apin)
Humidity = DHT.humidity
Temp = DHT.temperature
//3. PIR Sensor
PIR = digitalRead (inputPin);
```

Code:

```
//int sensor_pin = A0; // Soil Sensor input at Analog PIN A0
int output_value ;
void setup() {
  // put your setup code here, to run once:
  pinMode(4,OUTPUT);
  Serial.begin(9600);
  Serial.println("Reading From the Sensor ...");
  delay(2000);
}
// put your main code here, to run repeatedly:
void loop() {
  output_value= analogRead(sensor_pin);
  output_value = map(output_value,550,10,0,100);

  Serial.print("Mositure : ");
  Serial.print(output_value);
  Serial.println("%");

  if(output_value<0){
    digitalWrite(4,HIGH);
  }
  else{
    digitalWrite(4,LOW);
  }
  delay(1000);
}
```

3.3 Analytical

This proposed structure incorporates the Arduino Uno board with the assembled PC, the Raspberry pi. Pi is besides associated with one joined server that goes about as an intersection purpose of data trade among pi and the client (the farmers). Different notice concerning low stickiness, fertilizer required and interference will be given to the client through this application stage. This Application has 2 basic procedures for development, the one from which the client will pick when to butcher or on the electrical gadgets relying on the states of the homestead as point by point by the application from the estimations from the habitation by strategies for the sensors.



FIG. 10 Screenshot of Website Application

Arduino is related to so many sensors that sends the readings to get ready for the Arduino. The multiple sensors this structure has: soil clamminess sensor, electrochemical sensor, pH sensor, Passive Infrared Sensor, and moisture-temperature sensor.

HARDWARE TOOLS

Electro Chemical Sensor

IT uses an ISFET or ISE transistors to check voltage differentiation among cathode & the earth by expressions (H^+ , K^+ , NO_3^-) and consequently providing the farmers to pick manure with adding into the soil.

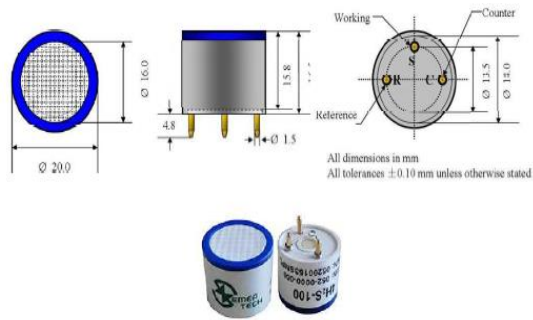

SOIL MOISTURE SENSOR

IT checks wetness level in (vol%) which then coordinated by the assistance of the 2 tests which thusly measure permittivity, from now on chop down the substance of water in the earth, higher the yield and the opposite route around.

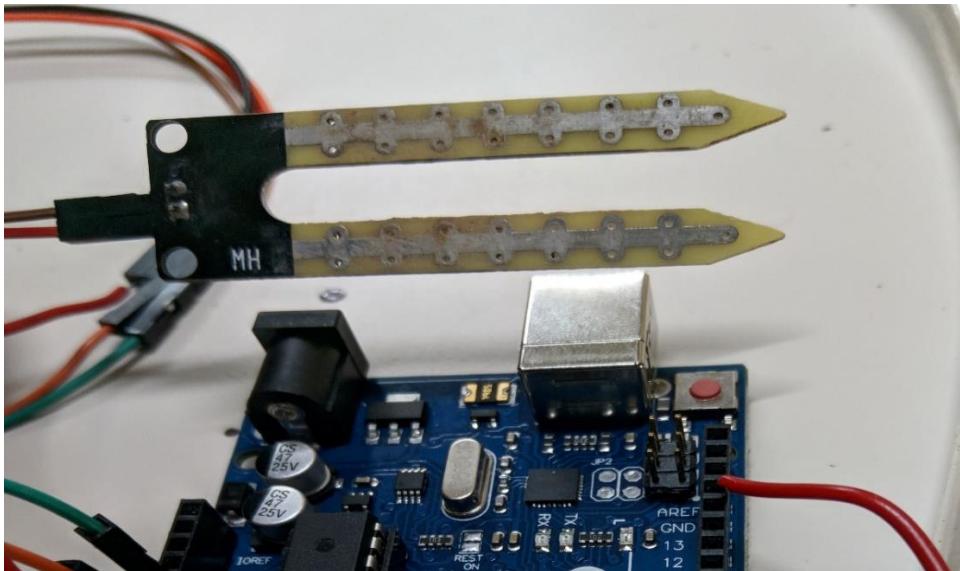

FIG. 12 Soil-Moisture Sensor

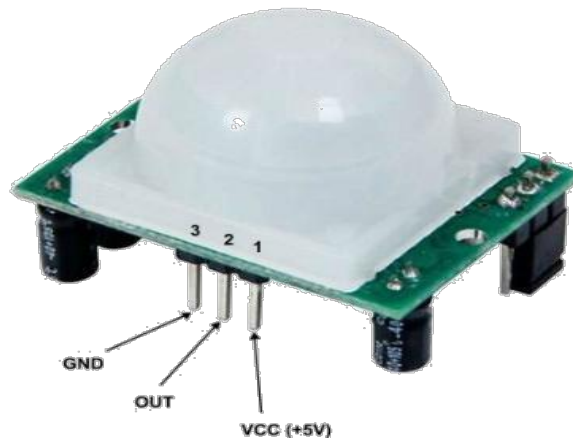

FIG. 11 PIR Motion Sensor

PIR Motion Sensor

The PIR is used for motion detection which is much better than the IR sensor as IR sensor senses the Infrared radiation by emitting an IR radiation and waiting for it to be re-bounced by some obstacle and hence it is able to recognize a motion. The PIR sensor does not radiate IR beams of its own instead they detect IR beams radiated from warm bodies and has two detectors if there is a blockage of IR on the first one and also on the second one only then the PIR sensor detects a motion.

PH sensor

This sensor evaluates the qualification in potential between the test/ substance and cathode.



FIG. 14 PH Sensor

Humidity & Temperature Sensor (DHT11)

It has 2 major units: 1st is for evaluating dampness and the other one is for detecting temperature which is essentially a thermometer. An Integrated Chip is present there which helps in setting up the results in form of readings for the microcontroller. The Moisture is estimated by computing the conductance of a fluid substance that transforms its stickiness.

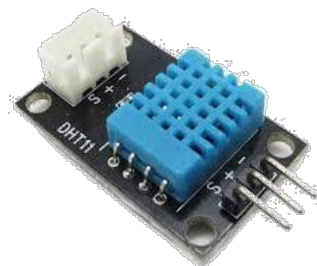

FIG. 13 Humidity- Temperature Sensor (DHT11)

SOFTWARE TOOLS

ARDUINO: ARDUINO is developed using the object oriented language and in Arduino the codes are written in C/C++. Arduino is the language which is only lot of capacities and classes.



FIG. 15 ARDUINO

The program or the code made and installed on the Arduino is known as the Sketch. Code is then installed on the Arduino Uno Board which at that point really plays out the necessary figurings, information assortment and further handling errands according to the code is composed.

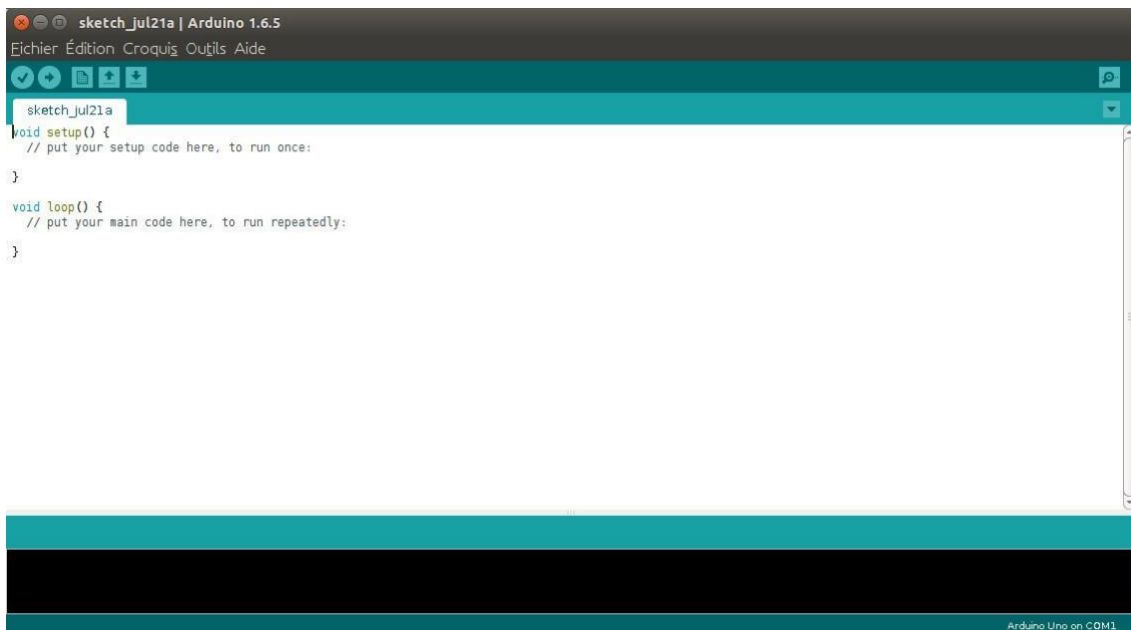

FIG. 16Sketch Arduino

Python: Integrated Development Environment(IDE) for python language. Information is transferred from the Arduino utilizing a sequential correspondence system to the nearby PC and afterward the information is prepared to utilize python by building up a python content that gathers all the information originating from the Arduino utilizing pySerial libraries.

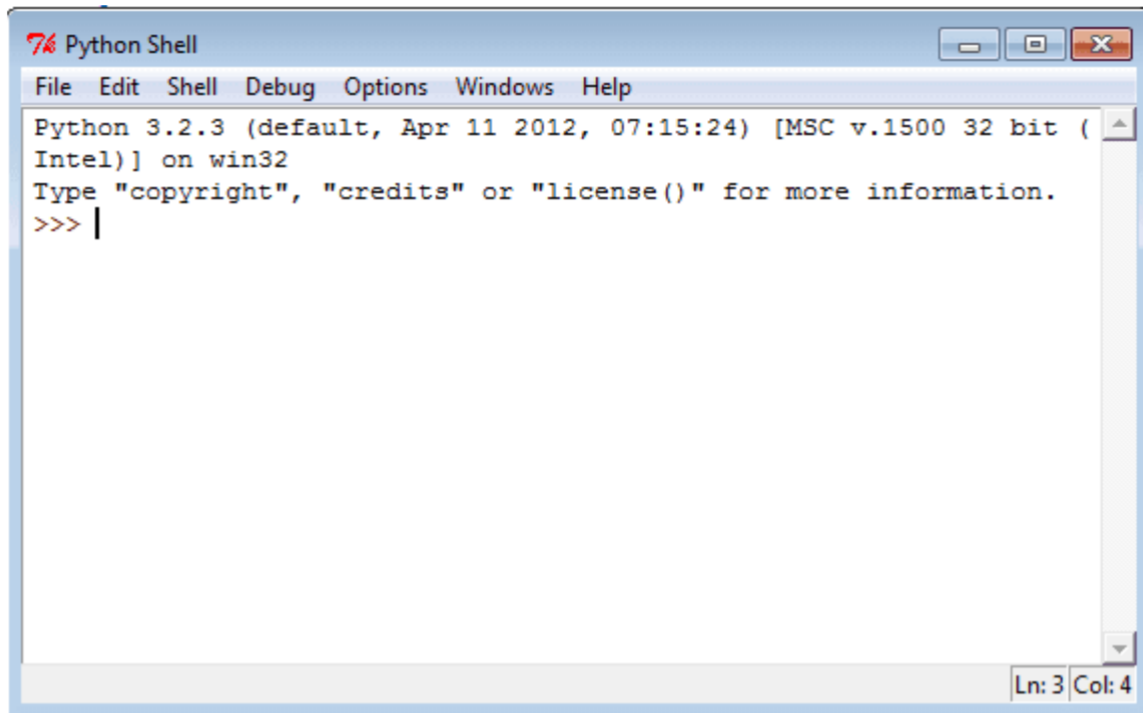

FIG. 16Python

MySQL: MySQL is one of the important and generally used Database. A database is a place where data is stored. Different application can use database to store information and data.



FIG. 19 MySQL

PHP: It is another language which I have used in this project to develop and create the backend of my website application required in this project and used here to make the backend of my site application.



FIG. 18 Php

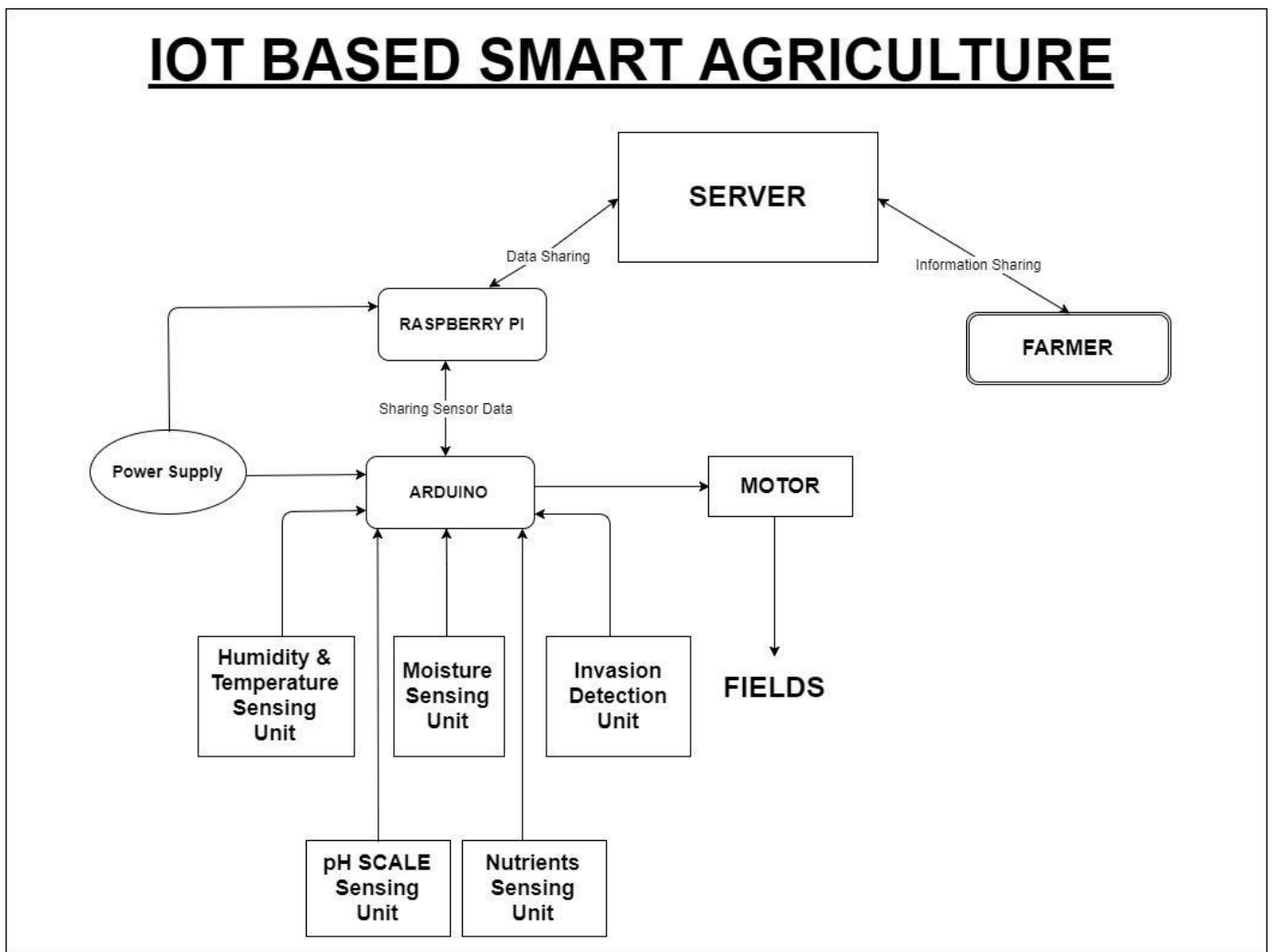

FIG. 20 Complete Data Flow Diagram

3.4 COMPUTATIONAL DATA

DHT11

DHT11 sensor measures humidity from the resistance and transfers the readings directly to the variable in Arduino code. Also the temperature readings come from the thermistor (NTC temperature sensor) mounted at the surface built into the system.

<dht.h> is the library which takes input from the sensor by using read11 () function present in dht.h library.

DHT.read11 (dht_apin)

After the data is read from sensor temperature and humidity can access from input of sensor as: Humidity = DHT.humidity

Temperature = DHT.temperature

Soil Moisture Sensor

The info from the sensor is simple and will store into a variable. The simple contribution from the sensor is required to be mapped between 0-100 since dampness perusing is estimated at rate as it were. In this way, mapping for this should be possible utilizing the accompanying capacity:

```
map(output_value,550,10,0,100).
```

The result for the sensor in dry soil is 550 and for wet soil it is 10. Along these lines, we mapped it from the scope of 10-550 from 0-100 utilizing map work as referenced previously.

3.5 By Experiment

c. Soil Properties for the Rice Crop

Property	Composition
Temperature (°C)	22 - 42
Moisture (%)	31 - 36
Humidity (%)	45 - 65
PH Range	5 - 6

d. Soil Properties for the Apple Crop^[25]

Property	Composition
Temperature (°C)	20 - 25
Moisture (%)	21 - 26
Humidity (%)	11-22
PH Range	5 - 6

e. Data Sample from the Sensor

		SMART	AGRICULTURE	SYSTEM		
DATE	TIME	SOIL MOISTURE	LIGHT INTEN.	HUMIDITY	TEMP.('C)	TEMP.('F)
25-10-15	16:31:01	346	32	31.21	27	80.6
25-10-15	16:31:03	347	34	31.21	17	62.6
25-10-15	16:31:04	344	33	31.21	28	82.4
25-10-15	16:31:06	388	33	31.21	34	93.2
25-10-15	16:31:07	651	32	31.21	21	69.8
25-10-15	16:31:09	651	33	31.21	30	86
25-10-15	16:31:10	651	33	31.21	27	80.6
25-10-15	16:31:12	550	31	31.21	17	62.6
25-10-15	16:31:13	418	33	31.21	17	62.6
25-10-15	16:31:15	309	33	31.21	25	77
25-10-15	16:31:16	328	32	31.21	32	89.6
25-10-15	16:31:18	344	32	31.21	26	78.8
25-10-15	16:31:19	354	35	31.21	31	87.8
25-10-15	16:31:21	357	33	31.21	28	82.4
25-10-15	16:31:22	341	33	31.21	31	87.8
25-10-15	16:31:24	352	34	31.21	36	96.8
25-10-15	16:31:25	347	32	31.21	21	69.8
25-10-15	16:31:27	352	34	31.21	17	62.6
25-10-15	16:31:28	343	33	31.21	22	71.6
25-10-15	16:31:30	351	34	31.21	35	95
25-10-15	16:31:31	347	34	31.21	31	87.8
25-10-15	16:31:33	342	32	31.21	29	84.2
25-10-15	16:31:34	339	34	31.21	31	87.8
25-10-15	16:31:36	343	32	31.21	25	77
25-10-15	16:31:37	339	31	31.21	36	96.8
25-10-15	16:31:39	345	34	31.21	22	71.6

f. Result from the Sensors

S. No.	Humidity	Temperature	Moisture	Date Time
1.	0	29	29	17/2/2020 21:23
2.	0	29	29	17/2/2020 21:24
3.	0	29	29	17/2/2020 21:24
4.	0	29	29	17/2/2020 21:24
5.	0	29	29	17/2/2020 21:24
6.	0	28	29	17/2/2020 21:24
7.	0	28	29	17/2/2020 21:24
8.	0	28	29	17/2/2020 21:25
9.	0	28	29	17/2/2020 21:25
10.	0	28	29	17/2/2020 21:25
11.	0	28	29	17/2/2020 21:25
12.	0	28	29	17/2/2020 21:25
13.	0	27	29	17/2/2020 21:25
14.	0	27	29	17/2/2020 21:26
21.	0	28	29	17/2/2020 21:26
16.	0	28	29	17/2/2020 21:26
17.	0	28	29	17/2/2020 21:26
18.	0	28	29	17/2/2020 21:26
19.	0	28	29	17/2/2020 21:26
20.	0	28	29	17/2/2020 21:27

CHAPTER - 4

PERFORMANCE ANALYSIS

All the gadgets and sensors has a defined arrangement of execution as structured from separate producers. Conversations with the sensors for lasting use for the soil and it will persistently be giving the readings all the time we should do a conformal covering which is essentially a shower that ought to be utilized on the sensors with the goal that they should not get eroded or harmed.



FIG. 21 Conformal Coating

Moisture Sensor:

g. Parameter of Soil Moisture Sensor

Model Name	YL -38
Range of Sensing	00 to 45% volume of water content in soil
Temperature	-35 °c to +50 °C
Power Consumed	3 mA
Operating Voltage	5v DC

Humidity-Temperature Sensor (DHT11):

h. Parameter of Temperature- Humidity Sensor (DHT11)^[19]

Range of Sensing	20-90% RH
Accuracy	±5% RH
Temperature Range	0-50 °C
Temperature Accuracy	±2% °C
Operating Voltage	3V to 5.5V

PIR Sensor:**i. Performance Parameter of PIR Sensor**

Range of Sensing	< 120 degree, in the range of 7m
“Methods of Trigger”	H - enable repeat L – disable repeat trigger
Time Delay	Adjust (3.5->5minutes)
Output(TTL)	3.5v, 0v
Consumption of Power	65 mA
Voltage	05v – 20v

PH Sensor:**j. Performance Parameter of PH Sensor**

Range of Sensing	0-14 pH
Operating Temperature	0-70
	±
Operating Voltage	5v
Time to Response	<1m

SNAPSHOTS: Snapshots of different stages of output:

In Arduino, the sensor which is popularly known as DHT11 Sensor collects data and information about temperature and moisture from the sensors in degree Celsius independently. Also soil moisture sensor gives us the information which is then mapped to the Arduino, and then PIR (latent infrared) sensor prevalently called as the movement recognition sensor detects the movement of a human being or mammals. Henceforth it is a perfect sensor for identifying obscure meddle in the ranch or field. So at whatever point there is a moving degraded like animal or people on the ranch a warning is sent to the farmers.

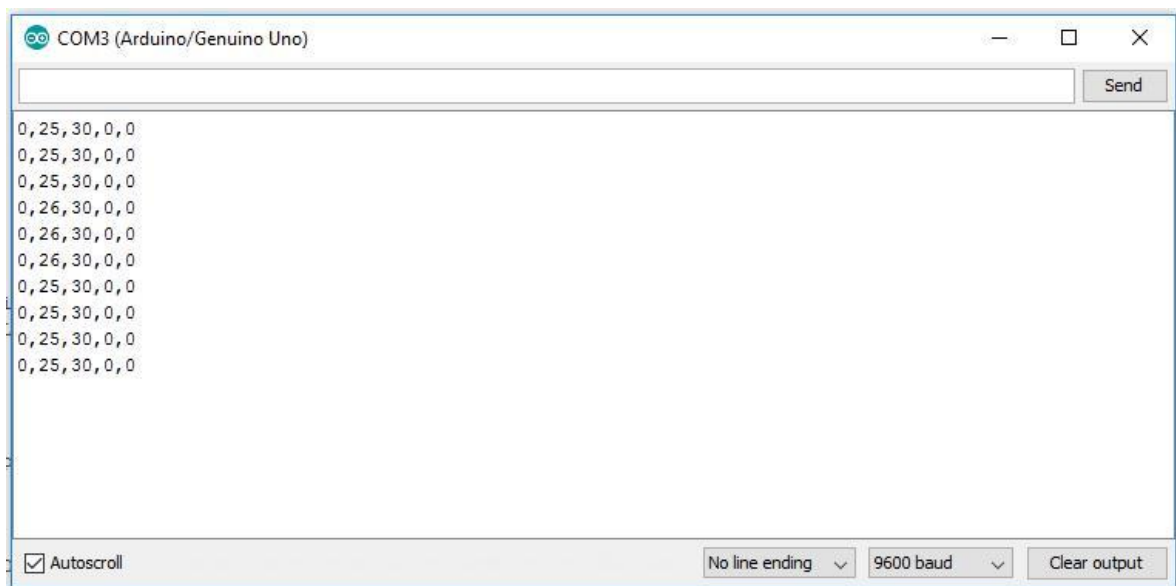

FIG. 22 Arduino Output

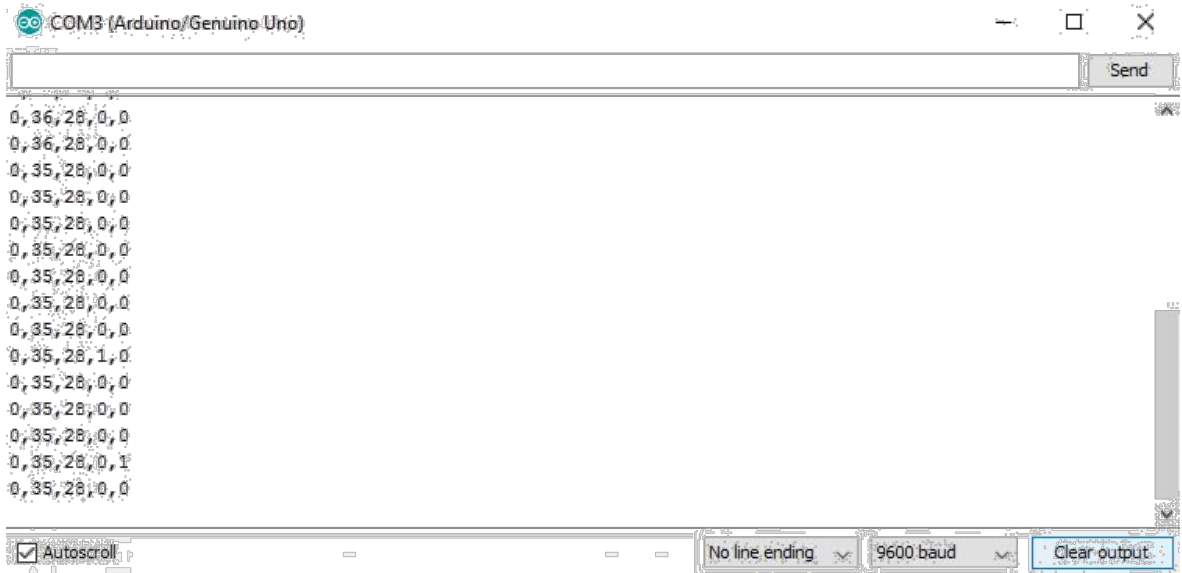
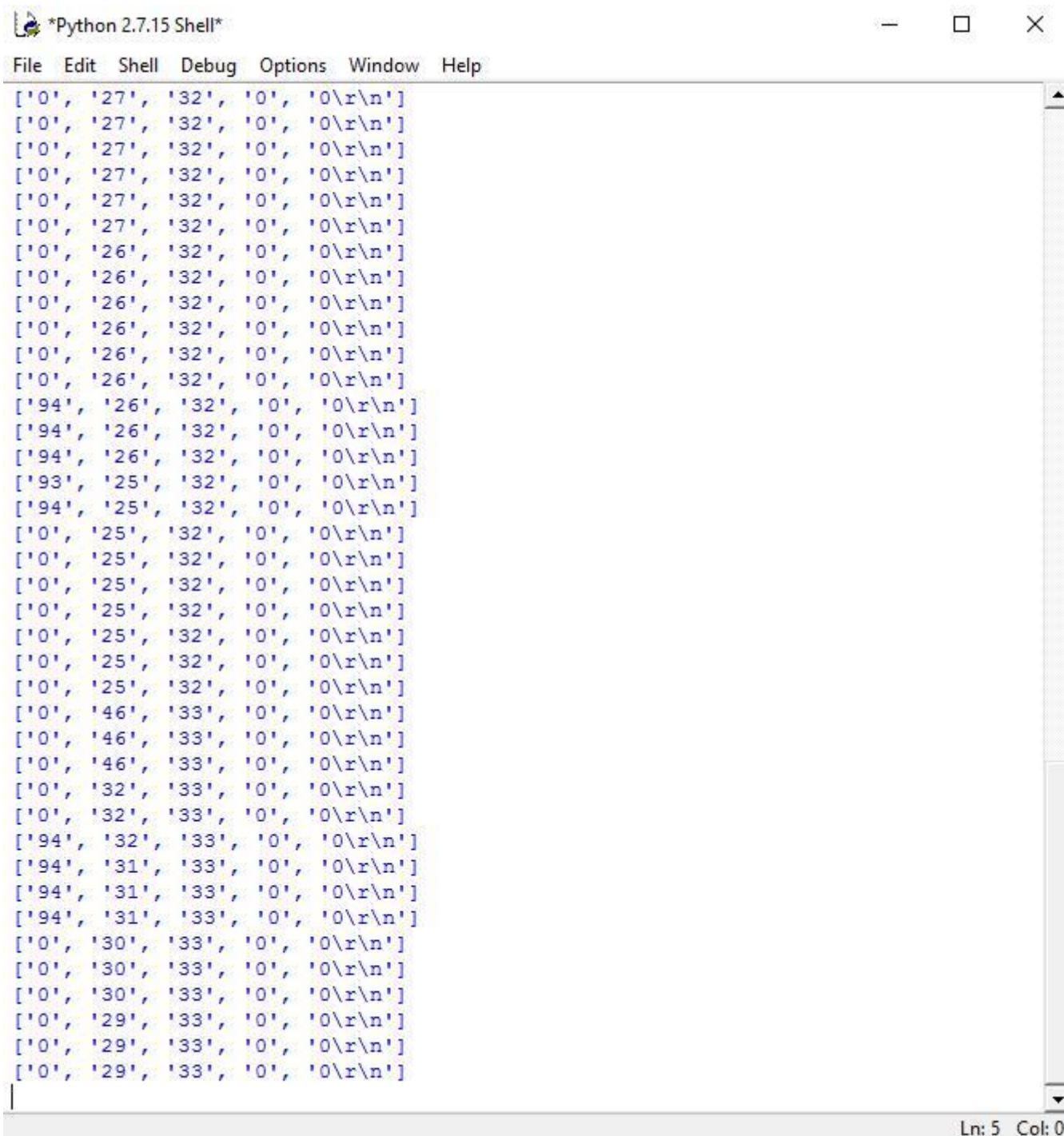

FIG. 23 Arduino Output

The python content gets these characteristics from the Arduino Uno using the py Serial module by methods for the successive port. Then the data is transferred to the MySQL database. Then the MySQL database stores some more information and then with the help of php code gets the data from the mysql database. Then the data is transferred to the website application and then processing of all those information with the help of Arduino.



```
*Python 2.7.15 Shell*
File Edit Shell Debug Options Window Help
['0', '27', '32', '0', '0\r\n']
['0', '27', '32', '0', '0\r\n']
['0', '27', '32', '0', '0\r\n']
['0', '27', '32', '0', '0\r\n']
['0', '27', '32', '0', '0\r\n']
['0', '27', '32', '0', '0\r\n']
['0', '27', '32', '0', '0\r\n']
['0', '26', '32', '0', '0\r\n']
['0', '26', '32', '0', '0\r\n']
['0', '26', '32', '0', '0\r\n']
['0', '26', '32', '0', '0\r\n']
['0', '26', '32', '0', '0\r\n']
['0', '26', '32', '0', '0\r\n']
['94', '26', '32', '0', '0\r\n']
['94', '26', '32', '0', '0\r\n']
['94', '26', '32', '0', '0\r\n']
['93', '25', '32', '0', '0\r\n']
['94', '25', '32', '0', '0\r\n']
['0', '25', '32', '0', '0\r\n']
['0', '25', '32', '0', '0\r\n']
['0', '25', '32', '0', '0\r\n']
['0', '25', '32', '0', '0\r\n']
['0', '25', '32', '0', '0\r\n']
['0', '25', '32', '0', '0\r\n']
['0', '25', '32', '0', '0\r\n']
['0', '25', '32', '0', '0\r\n']
['0', '46', '33', '0', '0\r\n']
['0', '46', '33', '0', '0\r\n']
['0', '46', '33', '0', '0\r\n']
['0', '32', '33', '0', '0\r\n']
['0', '32', '33', '0', '0\r\n']
['94', '32', '33', '0', '0\r\n']
['94', '31', '33', '0', '0\r\n']
['94', '31', '33', '0', '0\r\n']
['94', '31', '33', '0', '0\r\n']
['0', '30', '33', '0', '0\r\n']
['0', '30', '33', '0', '0\r\n']
['0', '30', '33', '0', '0\r\n']
['0', '29', '33', '0', '0\r\n']
['0', '29', '33', '0', '0\r\n']
['0', '29', '33', '0', '0\r\n']
Ln: 5 Col: 0
```

FIG. 24 Python Output - 1

```
Python 2.7.15 Shell
File Edit Shell Debug Options Window Help
['93', '25', '32', '0', '0\r\n']
['94', '25', '32', '0', '0\r\n']
['0', '25', '32', '0', '0\r\n']
['0', '25', '32', '0', '0\r\n']
['0', '25', '32', '0', '0\r\n']
['0', '25', '32', '0', '0\r\n']
['0', '25', '32', '0', '0\r\n']
['0', '25', '32', '0', '0\r\n']
['0', '25', '32', '0', '0\r\n']
['0', '46', '33', '0', '0\r\n']
['0', '46', '33', '0', '0\r\n']
['0', '46', '33', '0', '0\r\n']
['0', '32', '33', '0', '0\r\n']
['0', '32', '33', '0', '0\r\n']
['94', '32', '33', '0', '0\r\n']
['94', '31', '33', '0', '0\r\n']
['94', '31', '33', '0', '0\r\n']
['94', '31', '33', '0', '0\r\n']
['0', '30', '33', '0', '0\r\n']
['0', '30', '33', '0', '0\r\n']
['0', '30', '33', '0', '0\r\n']
['0', '29', '33', '0', '0\r\n']
['0', '29', '33', '0', '0\r\n']
['0', '29', '33', '0', '0\r\n']
['0', '28', '33', '0', '0\r\n']
['0', '28', '33', '0', '0\r\n']
['0', '28', '33', '0', '0\r\n']
['0', '28', '33', '0', '0\r\n']
['0', '28', '33', '0', '0\r\n']
['0', '28', '33', '0', '0\r\n']
['0', '28', '33', '0', '0\r\n']
['0', '27', '33', '0', '0\r\n']
['0', '27', '33', '0', '0\r\n']
['0', '27', '33', '0', '0\r\n']
['0', '27', '33', '1', '0\r\n']
['0', '27', '33', '0', '0\r\n']
['0', '26', '33', '0', '0\r\n']
['0', '26', '33', '0', '0\r\n']
['0', '26', '33', '0', '1\r\n']
['0', '26', '33', '0', '0\r\n']
Ln: 120 Col: 0
```

FIG. 25 Python Output - 2

Few Images:

1.

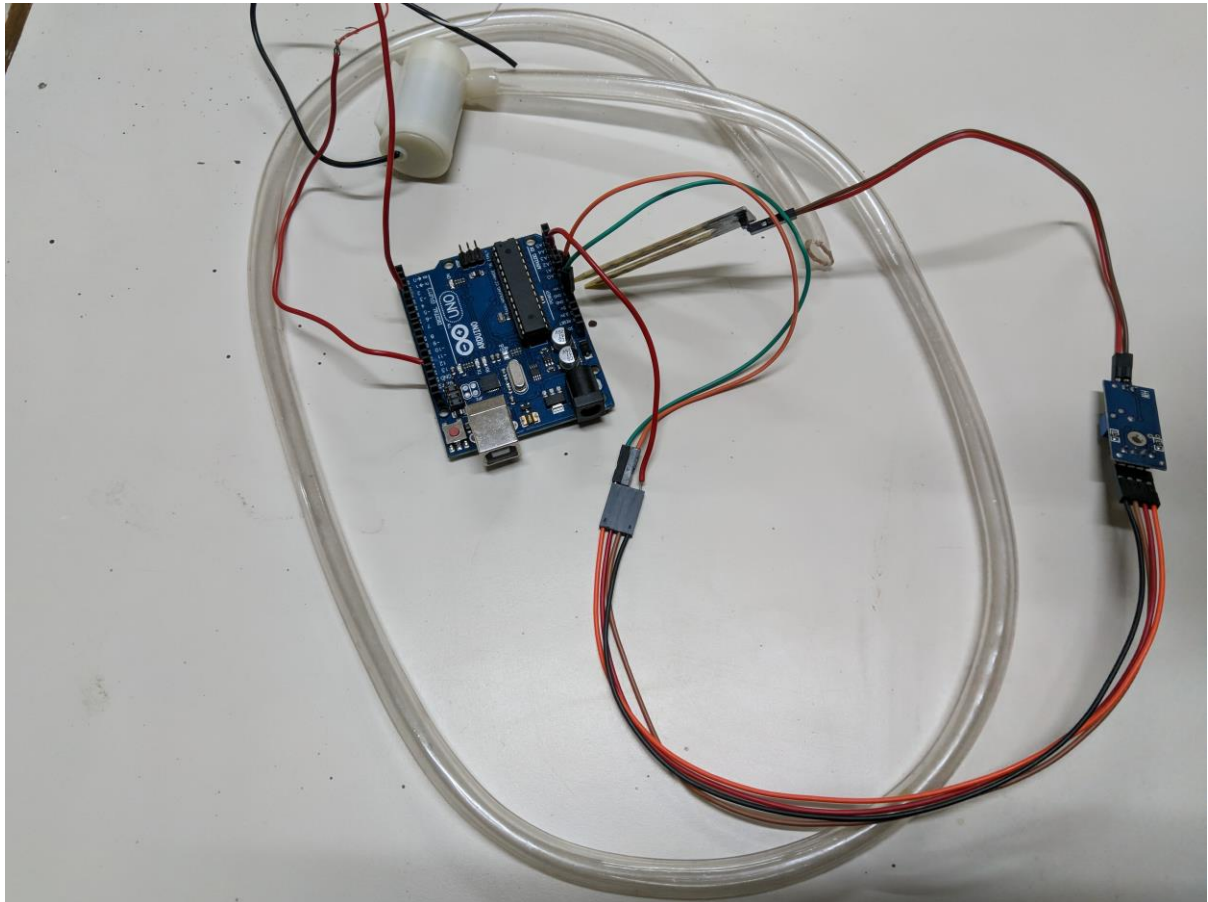

3.

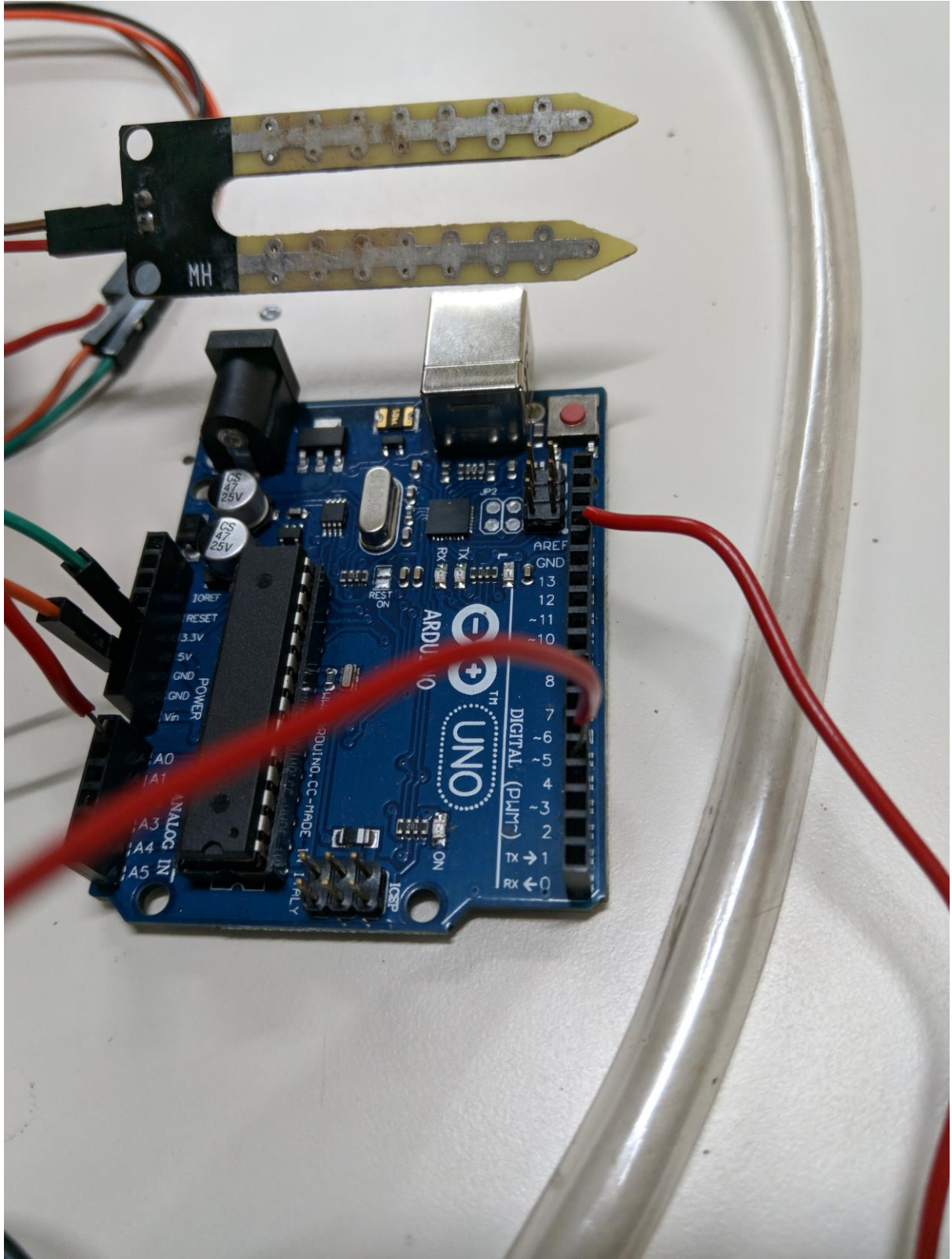

4.

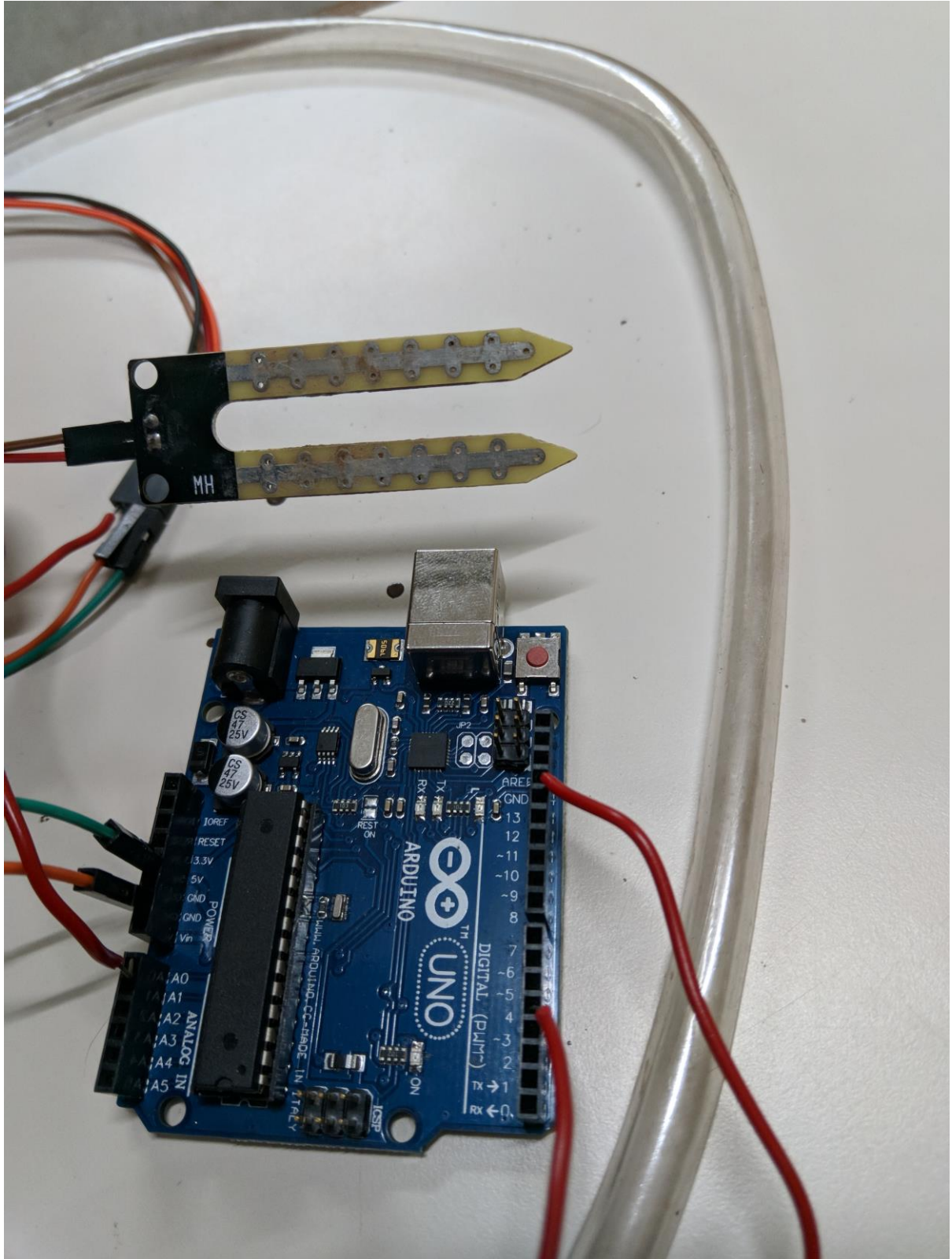

Chapter-5

CONCLUSIONS

Conclusions

The main purpose of the smart agriculture system is to provide and maintain the ideal environment in terms of soil moisture and temperature for the optimum growth of plant or crop. Hence with this framework wastage of yield by undesirable creatures, inappropriate water system, and soil disintegration can be maintained a strategic distance from and further water wastage can be decreased to a more noteworthy degree. The significant bit of leeway of this framework is that the activity of this framework can be changed by the circumstance and necessities of the harvest or farmers. This framework will help in the water system of agrarian grounds, parks, golf, gardens, ranches, and so on. In examination with other robotized frameworks, this framework is sensible, proficient, and simple to introduce and most significantly easy to use. For huge zones applications for an enormous scope with high affectability sensors with cutting edge strategies are executed. I have determined two fundamental ends which will be the premise of our further work, which are:

1: The framework need not to be mind-boggling and it need to be made as easy to use as could be expected under the circumstances so that there should not to be an issue with the establishment and utilization of framework.

2. The expense need to be limited to the most elevated conceivable level which we can accomplish.

Future Scope

The extent of this undertaking in the future could be like, the homesteads may be fused with water sprinkler and the developed framework may experience the necessary modifications which provides mechanization and progression of pesticides and water required by the dirt or the harvest as needs are.



FIG.34 (SIS)Smart Irrigation System

This model may have modules that may have harvest situated information and that too with territory area shrewd information which is vital as all the yields needn't bother with a similar measure of pesticides and water for various climatic conditions for ideal plant development. So these progressions may be consolidated into the proposed framework in the coming a very long time according to the prerequisites.

REFERENCES

1. N Kiruthika. "Investment and Returns in Indian Agricultural Research: A Theoretical Investigation". Research and Reviews: Journal of Agriculture and Allied Sciences, Vol. 3, Issue 1, January - March, 2014
2. Himani. "An Analysis of Agriculture Sector in Indian Economy". IOSR Journal Of Humanities And Social Science, Vol. 19, Issue 1, Ver. X, pp. 47-54, Feb. 2014
3. <http://www.knowledgebank.irri.org/step-by-step-production/growth/soil-fertility>
4. <https://www.hackster.io/renesas-team-sece/smart-agriculture-system-with-iot-2efb66>
5. Madhusudhan L, "Agriculture Role on Indian Economy, Business and Economics Journal", Vol. 6, Issue 4, 2021
6. Dr.N.Suma, Sandra Rhea Samson and S.Saranya, G.Shanmugapriya, R.Subhashri. "Smart Agriculture System Using IOT Monitoring System". International Journal on Recent and Innovation Trends in Computing and Communication, Vol. 5, Issue 2, February 2017
7. Aditi Mehta, Sanjay Patel. "Smart Agriculture System Using IOT Research Opportunities And Challenges". International Journal For Technological Research In Engineering, Vol. 4, Issue 3, November-2016.
8. Nikesh Gondchawar, Prof. Dr. R. S. Kawitkar. "Smart Agriculture System Using IOT". International Journal of Advanced Research in Computer and Communication Engineering, Vol. 5, Issue 6, June 2016.
9. Akshay Atole, Apurva Asmar and Amar Biradar, Nikhil Kothawade, Sambhaji Sarode, Rajendra G. Khope. "IOT Based Smart Farming System". International Journal of Emerging Technologies and Innovative Research, Vol. 4, Issue 4, April 2017.
10. Raheela Shahzadi, Javed Ferzund and Muhammad Tausif , Muhammad Asif Suryani. " Internet of Things based Expert System for Smart Agriculture". International Journal of Advanced Computer Science and Applications, Vol. 7, No. 9, 2016.
11. A. Paventhan. "Internet of Things based approach to Agriculture Monitoring". Asia-Pacific Advanced Network (APAN) 36th Meeting, 20 August 2013.
12. Dominique D. Guinard and Vlad M. Trifa, 2016, Building the Web of Things, Manning Publications Co. Greenwich, CT, USA, 324 p.
13. Marco Schwartz, 2014, Internet of Things with the Arduino Yún, Packt Publishing, 112 p.
14. <https://learn.adafruit.com/pir-passive-infrared-proximity-motion-sensor>
15. [https://www.dfrobot.com/wiki/index.php/DHT11_Temperature_and_Humidity_Sensor_\(SKU:_DFR0067\)](https://www.dfrobot.com/wiki/index.php/DHT11_Temperature_and_Humidity_Sensor_(SKU:_DFR0067))
16. Smart Garden,*instrucs*, <http://www.instrucs.com/id/Smart-Garden/>
17. <https://learn.sparkfun.com/tutorials/soil-moisture-sensor-hookup-guide>
18. <https://www.globalw.com/products/wq201.html>
19. <https://learn.adafruit.com/dht/overview>

20. lady ada, Pyroelectric ("Passive") InfraRed Sensors, adafruit, <https://learn.adafruit.com/pir-passive-infrared-proximity-motion-sensor/using-a-pir-w-arduino>
21. R.Sindhuja, B.Krithiga. "Soil Nutrient Identification Using Arduino". Asian Journal of Applied Science and Technology (AJAST), Vol. 1, Issue 4, Pages 40-42, May 2017.
22. Pema Chodon, Devi Maya Adhikari, Gopal Chandra Nepal, Rajen Biswa, Sangay Gyeltshen, Chencho. "Passive Infrared (PIR) Sensor Based Security System". International Journal of Electrical, Electronics and Computer Systems(IJEECS), Vol. 14, Issue 2, June 2013.
23. Ashish Sharma, Gaurav Tiwari, Durvijay Singh. "Low cost Solution for Temperature and Humidity monitoring and control System using Touch Screen Technology". International Journal of Latest Research in Engineering and Technology (IJLRET), Vol. 2, Issue 1, pp. 10-14, January 2016.
24. Deepak Kumar Roy and Murtaza Hassan Ansari. "Smart Irrigation Control System". International Journal of Environmental Research and Development, Vol. 4, pp. 371-374, November 2014.
25. <http://nhb.gov.in/pdf/fruits/apple/app012.pdf>