

A COMPUTATIONAL MODEL FOR CELL SURVIVAL/DEATH USING VHDL AND MATLAB SIMULATOR

SHRUTI JAIN*, PRADEEP K. NAIK^a, ROHIT SHARMA

Department of Electronics and Communication Engineering

^a*Department of Biotechnology & Bioinformatics*

Jaypee University of Information Technology, Solan-173215, India

A well-structured and controlled design methodology, along with a supporting hierarchical design system, has been developed to optimally support the development effort on several programs requiring gate array and semi custom Very Large Scale Integration (VLSI) design. In this paper, we will present an application of VLSI in System Biology. This work examines signaling networks that control the survival decision treated with combinations of three primary signals the pro death cytokine, *tumor necrosis factor- α* (TNF), and the pro survival growth factors, *epidermal growth factor* (EGF) and *insulin*. We have made model by taking three inputs, than made the truth table, Boolean equation and than implement the equation using Very High Speed Integrated Circuit Hardware Description Language (VHDL) (Xilinx Tool) and MATLAB simulator.

(Received August 20, 2009; accepted October 2, 2009)

Keywords: Tumor Necrosis Factor- α , Epidermal Growth Factor, Insulin, VHDL, MATLAB

1. Introduction

Very Large Scale Integration (VLSI) is the field, which involves packing more and more logic devices into smaller and smaller areas. The complexity of VLSIs being designed and used today makes the manual approach to design impractical. Our aim is to use VLSI in System Biology. Computational systems biology addresses questions fundamental to our understanding of life, yet progress here will lead to practical innovations in medicine, drug discovery and engineering. Substantial progresses over the past three decades in biochemistry, molecular biology and cell physiology, coupled with emerging high throughput techniques for detecting protein-protein interaction, have ushered in a new era in signal transduction research. Cell signaling pathways interact with one another to form networks. Such networks are complex in their organization and exhibit emergent properties such as bistability and ultrasensitivity [1]. To understand complex biological systems requires the integration of experimental and computational research - in other words systems biology approach. Computational biology, through pragmatic modeling and theoretical exploration, provides a powerful foundation from which to address critical scientific questions head-on. Studies of signaling pathways have traditionally focused on delineating immediate upstream and down stream interactions, and then organizing these interactions into linear cascades that relay and regulate information from cell surface receptors to cellular effectors such as metabolic enzymes, channels or transcription factors. This work examines signaling networks that control the survival decision treated with combinations of three primary signals [2, 3] the pro death cytokine, *tumor necrosis factor- α* (TNF) [4, 5], and the pro survival growth factors, *epidermal growth factor* (EGF) [6, 7] and insulin [8, 9, 10]. The system output is typically a phenotypic readout (death or survival); however, it can also be determined by measuring “early” signals that perfectly correlate with the death/ survival output. Examples of such early signals include phosphatidylserine exposure, membrane permeability, nuclear

fragmentation and caspase substrate cleavage. We have implemented the signaling system heading by three input signals such as TNF, EGF and insulin. Figure 1 illustrate the system under study linking the three input signaling such as TNF, EGF and Insulin and four output signals phosphatidylserine exposure, membrane permeability, nuclear fragmentation and caspase substrate cleavage leading to cell death/ survival.

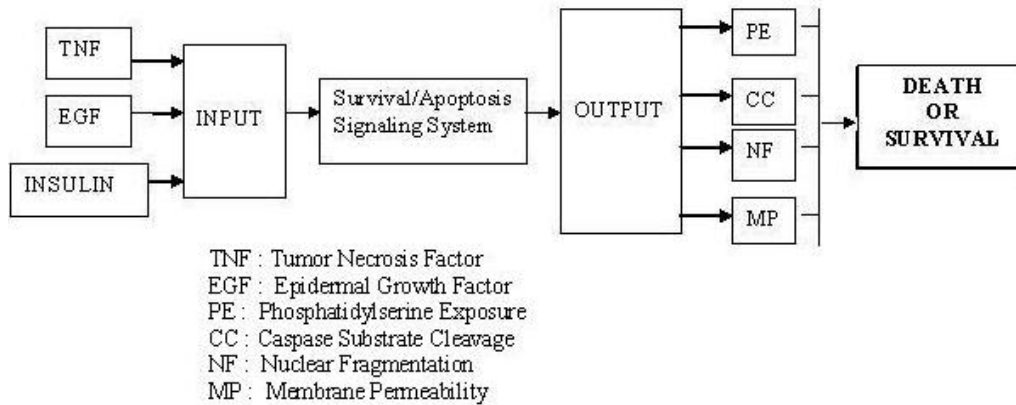

Fig. 1. Illustration of the system.

2. Materials and methods

2.1 Experimental

The experimental observation of cell survival/ death from cells treated with ten cytokine combinations of tumor necrosis factor- α (TNF), a pro apoptotic cytokine, in combination with epidermal growth factor (EGF) or insulin, two pro survival growth factors has been worked out by Gaudet et al. They have predicted with the response of cell survival as well as cell death with 94 % accuracy by including eleven different proteins such as Mitogen-activated protein kinase-activated protein kinase 2 (MK2), c-jun N-terminal kinases(JNK), Forkhead transcription factor (FKHR), Mitogen-activated protein kinase and extracellular-regulated kinase (MEK), Extracellular-regulated kinase (ERK), Insulin receptor substrate (IRS), Akt, IKK, Phospho-to-total EGFR (ptEGFR), Phospho-to-total Akt (ptAkt), pAkt. All the eleven proteins forms signaling network which leads to cell survival/ death. The response of signaling network is regulated by the concentration of cytokines like TNF, EGF and Insulin. Therefore, it is possible to built self consistent compendia cell signaling data based on the above eleven proteins that can be simulated computationally to yield important insites into the control of cell survival/ death.

2.2 computational model:

The prediction model for cell death/ survival has been implemented using Xilinx and MATLAB simulator. We have implemented the signaling system heading by three input signals such as TNF, EGF and insulin.

2.2.1 Tumor Necrosis Factor- α (TNF):

There are two receptors, **TNF-R1** (TNF receptor type 1) and **TNF-R2** (TNF receptor type 2), bind to TNF [4]. TNF-R1 is constitutively expressed in most tissues, and can be fully activated by both the membrane-bound and soluble trimeric forms of TNF, while TNF-R2 is only found in cells of the immune system and respond to the membrane-bound form of the TNF homotrimer. As most information regarding TNF signaling is derived from TNF-R1, the role of TNF-R2 is likely underestimated. Upon contact with their ligand, TNF receptors also form trimers, their tips fitting into the grooves formed between TNF monomers. This binding causes a conformational change to occur in the receptor, leading to the dissociation of the inhibitory protein SODD from the intracellular death domain. This dissociation enables the adaptor protein TRADD to bind to the

death domain, serving as a platform for subsequent protein binding. TNF receptor associated factor 2 (TRAF2) is a prototypical member of the TRAF family proteins that regulates signals from the TNF receptors [11], resulting in sequential activation of MAP3K (MEKK1/3, ASK1/2) [12], MAP2K (MKK3, 4, 6, 7) [13] and MAPK (JNK, p38) [14], as well as in activation of RIP/IKK signaling pathways. MAPK and IKK in turn activate AP-1 and NF- κ B transcription factors. Activation of AP-1 and NF- κ B induces genes involved in inflammation, immune response, cell proliferation and cell differentiation, as well as genes that act to suppress death receptor- and stress-induced apoptosis. The signaling pathways from RIP/IKK to NF- κ B and from MAP3K to AP-1 are better understood, the receptor proximal events that determine TRAF2-dependent activation of RIP/IKK vs. MAP3K remain largely elusive shown in Figure 2.

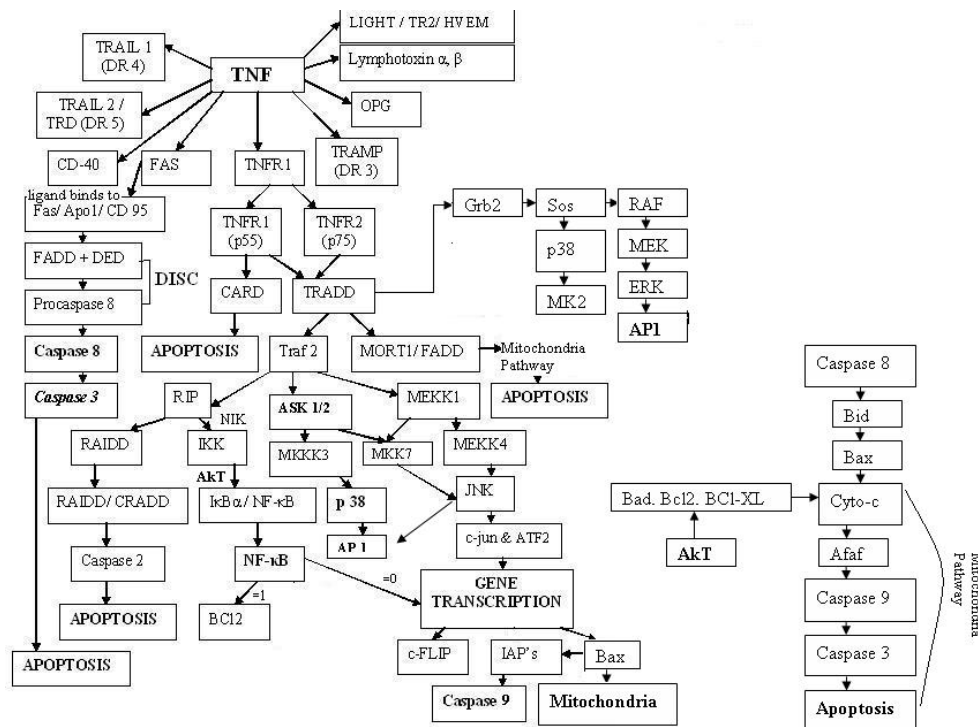

Fig. 2. TNF Pathway.

The following TRADD binding pathways can be initiated as

2.2.1.1 Activation of NF- κ B: NF- κ B is a heterodimeric transcription factor that translocates to the nucleus and mediates the transcription of a vast array of proteins involved in cell survival and proliferation, inflammatory response, and anti-apoptotic factors. As such, many different types of human tumors have misregulated NF- κ B: that is, NF- κ B is constitutively active. Active NF- κ B [2, 3] turns on the expression of genes that keep the cell proliferating and protect the cell from conditions that would otherwise cause it to die. In tumor cells, NF- κ B is active either due to mutations in genes encoding the NF- κ B transcription factors themselves or in genes that control NF- κ B activity (such as I κ B genes); in addition, some tumor cells secrete factors that cause NF- κ B to become active. Blocking NF- κ B can cause tumor cells to stop proliferating, to die, or to become more sensitive to the action of anti-tumor agents. Thus, NF- κ B is the subject of much active research among pharmaceutical companies as a target for anti-cancer therapy. TRADD recruits TRAF2 and RIP. TRAF2 in turn recruits the multicomponent protein kinase IKK, enabling the serine-threonine kinase RIP to activate it. An inhibitory protein, I κ B β , that normally binds to NF- κ B and inhibits its translocation, is phosphorylated by IKK and subsequently degraded, releasing NF- κ B. NF- κ B is a family of transcription factors, which induce the expression of a wide variety of genes, especially those involved in survival, such as the Bcl-2 family member Bfl-1, and the caspase inhibitors c-IAP1 and c-IAP2. Binding with I κ B sequesters it to the cytoplasm. Upon

phosphorylation of I κ B by IKK α and IKK β , I κ B is degraded and NF- κ B can enter the nucleus to induce transcription. It must be noted that NF- κ B does not appear to be directly phosphorylated by Akt, but indirectly activated.

2.2.1.2 Activation of the MAPK pathways: MAP kinases act as an integration point for multiple biochemical signals, and are involved in a wide variety of cellular processes such as proliferation, differentiation, transcription regulation and development. This kinase is activated by various cell stimuli, and targets specific transcription factors, and thus mediates immediate-early gene expression in response to cell stimuli. The activation of this kinase by tumor necrosis factor alpha (TNF- α) is found to be required for TNF- α induced apoptosis. This kinase is also involved in UV radiation induced apoptosis, which is thought to be related to cytochrome-c mediated cell death pathway. Of the three major MAPK cascades, TNF induces a strong activation of the stress-related JNK group, evokes moderate response of the p38- MAPK, and minimal activation of the classical ERKs. TRAF2 activates the JNK-inducing upstream kinases of MEKK1 and ASK1, and these two kinases phosphorylate MKK7, which then activates C-Jun N-terminal kinases (JNKs), originally identified as kinases that bind and phosphophorylate c-jun on Ser63 and Ser73 within its transcriptional activation domain, are mitogen-activated protein kinase which are responsive to stress stimuli, such as cytokines, ultraviolet, irradiation, heat shock, and osmotic shock, and are involved in T cell differentiation and apoptosis. JNK translocates to the nucleus and activates transcription factors such as c-jun and ATF2. The JNK pathway is involved in cell differentiation, proliferation, and is generally pro-apoptotic. JNK, by phosphorylation, modifies the activity of numerous proteins that reside at the mitochondria or act in the nucleus. This way, JNK activity regulates several important cellular functions. JNK1 is involved in apoptosis, neuro degeneration, cell differentiation and proliferation, inflammatory conditions and cytokine production mediated by AP-1 (Activation Protein 1).

2.2.1.3 Induction of death signaling: Like all death-domain containing members of the TNFR superfamily, TNF-R1 is involved in death signaling. However, TNF-induced cell death plays only a minor role compared to its overwhelming functions in the inflammatory process. Its death inducing capability is weak compared to other family members (such as Fas), and often masked by the anti-apoptotic effects of NF- κ B. Nevertheless, TRADD binds FADD, which then recruits the cysteine protease caspase 8 [15]. A high concentration of caspase 8 induces its autoproteolytic activation and subsequent cleaving of effector caspases, leading to cell apoptosis [16, 17].

Cell death is an essential strategy for the control of the dynamic balance in living systems, and two fundamentally different forms of cell death, *apoptosis and necrosis* [18], have been defined.

2.2.2 Epidermal Growth Factor (EGF) :

Upon ligand-binding receptors homo-dimerise or hetero-dimerise triggering tyrosine [19] trans-phosphorylation of the receptor sub-units. Intracellular tyrosine kinases of the Src family and Abl family are also able to tyrosine phosphorylate ErbB receptors. These tyrosine phosphorylated sites allow proteins to bind through their Src homology 2 (SH2) domains leading to the activation of downstream signaling cascades including the RAS/extracellular signal regulated kinase (ERK) pathway, the phosphatidylinositol 3 kinase (PI3K) pathway and the Janus kinase/Signal transducer and activator of transcription (JAK/ STAT) pathway as shown in Figure 3. Differences in the C-terminal domains of the ErbB receptors govern the exact second messenger cascades that are elicited conferring signaling specificity. The EGF signal is terminated primarily through endocytosis of the receptor-ligand complex. A number of signal transduction pathways branch out from the receptor signalling complex.

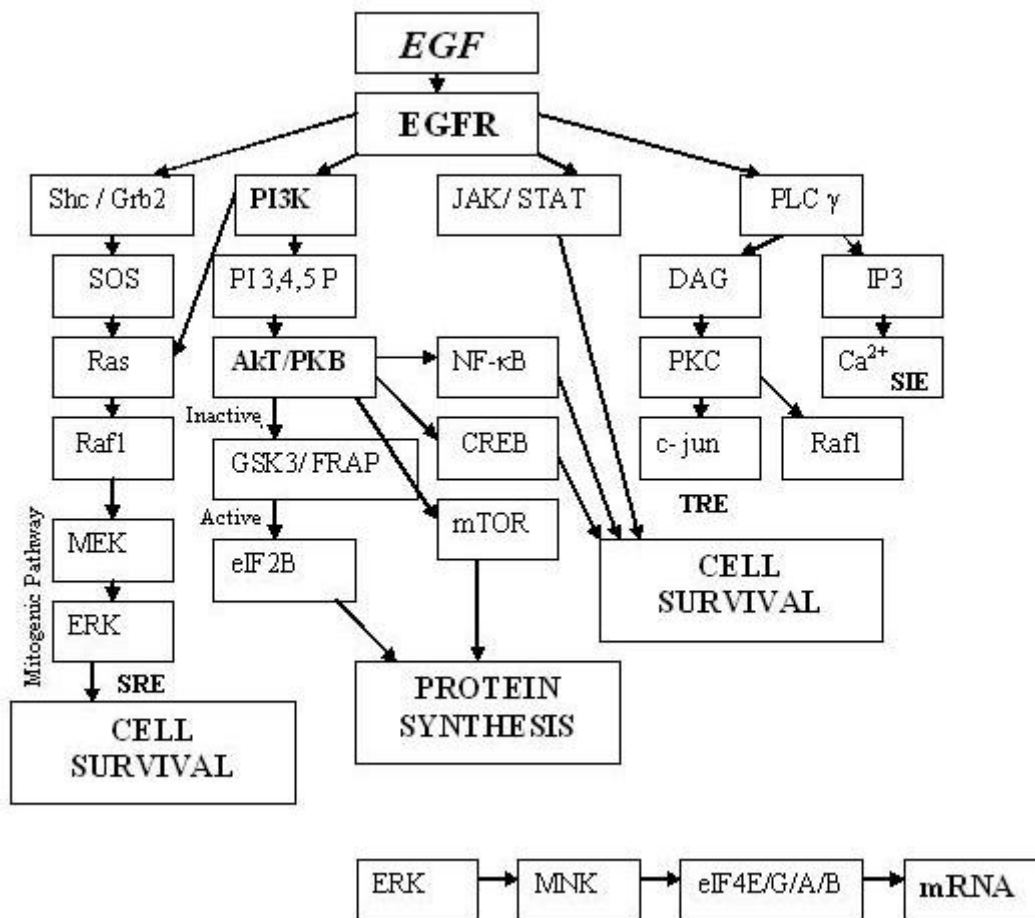

Fig. 3. EGF Pathway.

2.2.2.1 The RAS/ERK pathway: EGF activates the ERK pathway through the binding of Grb2 or Shc to phosphorylated ErbB receptors, which in turn results in the recruitment of the son of sevenless (SOS) to the activated receptor dimer. SOS then activates RAS leading to the activation of RAF-1 [20]. RAF-1 subsequently phosphorylates MEK1 and MEK2 which activate respectively ERK 1 and ERK2. This pathway results in cell proliferation and in the increased transcription of Bcl2 family members and inhibitors of apoptosis proteins (IAPs), thereby promoting cell survival. Mitogenic signalling increases the rate of translation of selective mRNAs. ERK plays a role in initiating protein synthesis by phosphorylating Mnk1 which results in the removal of secondary structure at the initiation site for protein synthesis. Mnk1 is also the target for some viruses when hijacking cellular protein synthesis.

2.2.2.2 Pathways of MAP kinase : MAP kinases are actually a family of protein kinases that are widely distributed and are found in all eukaryotic organisms. These can be classified into three main functional groups [12, 14]. The first is mediated by mitogenic and differentiation signals. The other two respond to stress and inflammatory cytokines. The ERK pathway responds to mitogen activation. In the JNK/SAPK pathway SAPK stands for stress activation protein kinase and within this class of kinases the Jun N-terminal kinases (JNK) form a subfamily. In the p38/HOG pathway HOG stands for high osmolarity glycerol where the p38 proteins are a subfamily. Each of these pathways led to the dual phosphorylation of MAP kinase family members responsible for activation of transcription factors. Cytokines and growth factors activate the mitogen-activated protein (MAP) kinase pathways resulting in the stimulation of ERK1/2, c-Jun N-terminal kinases and p38 kinases which in turn activate transcription factors like AP-1 and ATF-2. Other proinflammatory agents like TNF- α , IL-1 and LPS activate the transcription factor NF- κ B which participates in the regulation of expression of immediate early genes involved in immune, acute phase and inflammatory responses. Besides the transcription factors NF- κ B and AP-1 which are immediate-early transcriptional activators, components of the JAK/STAT pathway play an

important role in the transcriptional activation of many inflammatory genes. Consensus sequences for the transcription factors NF- κ B, AP-1 and STAT1a have been found.

2.2.2.3 PI3 kinase/AKT pathway: EGF also promotes cell survival through the activation of PI3 kinase/AkT signaling [2, 3]. EGF triggers the recruitment of PI3 kinase to activated ErbB receptors, which is mediated by the binding of SH2 domains in PI3 kinase to phosphorylated tyrosine residues. The catalytic subunit of PI 3-kinase in turn phosphorylates phosphatidylinositol (4, 5) biphosphate (PtdIns (4, 5)P₂) leading to the formation of PtdIns(3,4,5)P₃. PI 3-kinase can also activate RAS, resulting in the activation of ERK signaling, thereby facilitating cross-talk between survival pathways. A key downstream effector of PtdIns(3,4,5)P₃ is AKT (PKB). AKT promotes cell survival through the transcription of anti-apoptotic proteins [21]. Intermediate transcription factors involved in this process are NF κ B and CREB. Another downstream target of AKT is glucogen synthase kinase 3 (GSK3). Under basal conditions the constitutive activity of GSK3 leads to the phosphorylation and inhibition of a guanine nucleotide exchange factor eIF2B, which regulates the initiation of protein translation. Therefore, upon inactivation of GSK3 by AKT, eIF2B is dephosphorylated resulting in the promotion of protein synthesis and the storage of amino acids [12, 14]. AKT also activates mammalian target of rapamycin (mTOR) [22], which promotes protein synthesis through p70 ribosomal S6 kinase (p70s6k) and inhibition of eIF-4E binding protein (4E-BP1). Collectively, these processes all promote cell growth and survival in response to EGF.

2.2.2.4 JAK/STAT pathway : Another signaling cascade initiated by EGF is the JAK/STAT pathway, which is also implicated in cell survival responses [23]. JAK phosphorylates STAT proteins localized at the plasma membrane. This leads to the translocation of STAT proteins to the nucleus where they activate the transcription of genes associated with cell survival

2.2.2.5 PLC- γ Pathway : Activation of PLC gamma results in the generation of DAG and IP3 which subsequently activates PKC and the release of Ca²⁺. Activation of PKC in the dephosphorylation of cJun with the subsequent activation TREs. Activation of Grb2 results in the binding of the GTP exchange factor SOS which facilitates the activation of Ras and the MAP pathway. Activation can facilitate complex formation and additional modification that would not otherwise occur.

2.2.3 Insulin

2.2.3.1 PI3K Pathway: PI3K is also activated by insulin, insulin-like growth factor-1 and other growth factors. PI3K is a heterodimeric lipid kinase with a broad range of cellular functions, including growth and differentiation, synthesis and degradation of carbohydrates, proteins and lipids, and membrane trafficking. PI3K consists of a regulatory subunit that associates with a catalytic subunit. The regulatory subunit binds the IRSs, whereas the catalytic subunit phosphorylates phosphatidylinositols in the membrane. PI3K is supposed to phosphorylate phosphatidylinositol 4, 5-bisphosphate at position 3 of the inositol ring to generate the putative lipid second messenger, phosphatidylinositol 3, 4, 5-trisphosphate. Inhibition of PI3K by either Wortmannin or LY-294002 blocks the formation of phosphatidylinositol 3,4,5-trisphosphate within the cell and leads to the inhibition of several intracellular events, most importantly Glucose transporter 4 (GLUT4) translocation, thereby inhibiting insulin-stimulated glucose transport in the skeletal muscle. A new pathway suggests that CAP (Cbl-associated protein)/Cbl may play a role in glucose uptake. CAP/Cbl is recruited to the insulin receptor in 3T3-L1 adipocytes and disruption of this interaction attenuates insulin-stimulated glucose transport shown in Figure 4.

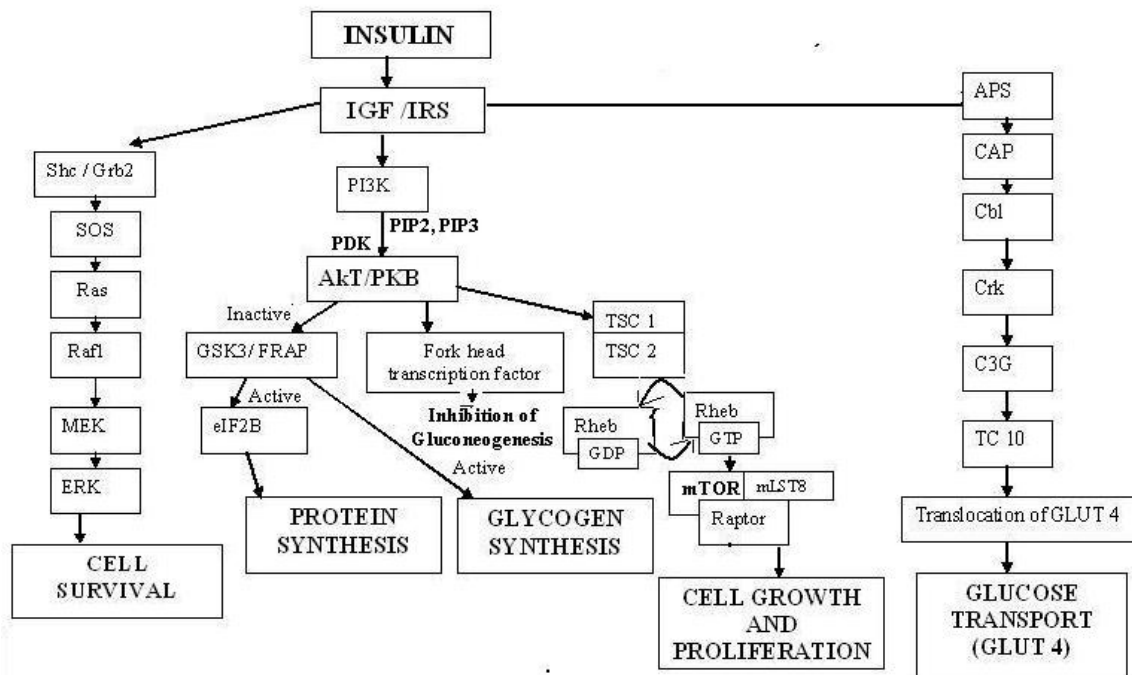

Fig. 4. Insulin Pathway.

The importance of this pathway is unknown in human insulin-sensitive tissues and the role of this pathway in the skeletal muscle is not clear. PDK (phosphoinositide-dependent protein kinase)/Akt (protein kinase B, c-Akt) is one of the serine/threonine kinases downstream of PI3K. Akt was originally implicated in cancer development, promoting cell proliferation and inhibition of apoptosis. Insulin and other growth factors acutely activate Akt [24, 25, 26]

2.2.3.1.1 GSK 3 Pathway : Receptor activation leads to the phosphorylation of key tyrosine residues on IRS proteins, some of which are recognised by the Src homology 2 (SH2) domain of the p85 regulatory subunit of PI 3-kinase (a lipid kinase). The catalytic subunit of PI 3-kinase, p110, then phosphorylates phosphatidylinositol (4,5) bisphosphate (PtdIns(4,5)P₂) leading to the formation of Ptd(3,4,5)P₃. A key downstream effector of Ptd(3,4,5)P₃ is AKT (otherwise known as PKB), which is recruited to the plasma membrane. Activation of AKT also requires the protein kinase 3-phosphoinositide-dependent protein kinase-1 (PDK1), which in combination with a yet unidentified kinase leads to the phosphorylation of AKT [24]. Once active, AKT enters the cytoplasm where it leads to the phosphorylation and inactivation of glycogen synthase kinase 3 (GSK3). A major substrate of GSK3 is glycogen synthase, an enzyme that catalyses the final step in glycogen synthesis. Phosphorylation of glycogen synthase by GSK3 inhibits glycogen synthesis; therefore, the inactivation of GSK3 by AKT promotes glucose storage as glycogen. In addition to promoting glucose storage, insulin inhibits the production and release of glucose by the liver by blocking gluconeogenesis and glycogenolysis [27]. Insulin directly controls the activities of a set of metabolic enzymes by phosphorylation and dephosphorylation events and also regulates the expression of genes encoding hepatic enzymes involved in gluconeogenesis.

2.2.3.1.2 Pathway of m TOR: Using cell biological, biochemical, genomic, and proteomic approaches, we are uncovering the complex molecular understanding of a signaling network centered around a G protein switch involving the tuberous sclerosis complex (TSC) tumor suppressors (TSC1 and TSC2) and the Ras-related small G protein Rheb. A complex between TSC1 and TSC2 is regulated by multi-site phosphorylation and acts as a point of integration for a diverse array of cellular signals, including those arising from growth factors, nutrients, and a variety of stress conditions. When active, the TSC1-TSC2 complex [26, 28] acts as a GTPase activating protein (GAP) for Rheb, thereby turning Rheb off by stimulating its intrinsic GTPase activity. In the presence of growth factors and nutrients, this complex is turned off, allowing the

GTP-bound active version of Rheb to accumulate and turn on downstream pathways. The best-characterized downstream effectors of Rheb is the mammalian target of rapamycin complex 1 (mTORC1), a critical regulator of cell growth and proliferation.

2.2.3.1.3 Pathway of FKHR: Although genetic analysis has demonstrated that members of the winged helix, or forkhead, family of transcription factors play pivotal roles in the regulation of cellular differentiation and proliferation [27, 29] both during development and in the adult, little is known of the mechanisms underlying their regulation. Here we show that the activation of phosphatidylinositol 3 (PI3) kinase by extracellular growth factors induces phosphorylation, nuclear export, and transcriptional inactivation of FKHR1, a member of the FKHR subclass of the forkhead family of transcription factors. Phosphorylation by PKB/Akt negatively regulates FKHR1 by promoting export from the nucleus. The consistent involvement of members of the FKHR subclass of the winged helix family in chromosomal translocations found in human cancer suggests that members of this subclass may play a critical role in the regulation of cellular proliferation and/or differentiation. Thus, an understanding of the mechanisms underlying their regulation may provide insight into the role of not only the FKHR subclass, but also the larger winged helix family in normal and neoplastic development. Here we sought, by biochemical and genetic analyses, to determine whether the activity of FKHR1, a member of the FKHR subclass of forkhead-related proteins, is subject to regulation.

2.2.3.2 Pathway GLUT 4 (Glucose transport): The rate-limiting step in whole body glucose metabolism under normoglycaemic conditions is the transport of glucose into the skeletal muscle cells [30]. Glucose enters the cell by facilitated diffusion mediated by a group of structurally related GLUT proteins. In skeletal muscle and adipose tissue, GLUT1 mediates basal glucose transport, whereas GLUT4 is responsible for insulin-mediated glucose uptake. Exercise, independently from insulin, also promotes GLUT4 translocation and glucose transport in the skeletal muscle. Insulin-stimulated glucose transport is reduced in the skeletal muscle from Type II diabetic subjects. Whereas total GLUT4 protein expression is unchanged in these subjects, cell surface GLUT4 content is reduced under insulin-stimulated conditions. A key action of insulin is to stimulate glucose uptake into cells by inducing translocation of the glucose transporter, GLUT4, from intracellular storage to the plasma membrane. PI 3-kinase and AKT are known to play a role in GLUT4 translocation. In addition, a PI 3-kinase independent pathway provides a second cue for GLUT4 recruitment to the plasma membrane. In this pathway, insulin receptor activation leads to the phosphorylation of Cbl, which is associated with the adaptor protein CAP. Following phosphorylation the Cbl-CAP complex translocates to lipid rafts in the plasma membrane. Cbl then interacts with the adaptor protein Crk, which is constitutively associated with the Rho-family guanine nucleotide exchange factor, C3G. C3G in turn activates members of the GTP-binding protein family, TC10 [31], which promote GLUT4 translocation to the plasma membrane through the activation of as yet unknown adaptor molecules.

2.2.3.3 MAPK Pathway (Mitogenic responses) : Other signal transduction proteins interact with IRS including GRB2, an adaptor protein that contains SH3 domains, which in turn associates with the guanine nucleotide exchange factor son-of sevenless (sos) and elicits activation of the MAPK cascade leading to mitogenic responses [11, 13, 14]. SHC is another substrate for the insulin receptor. Upon phosphorylation SHC associates with GRB2 and can therefore activate the MAPK pathway independently of IRS. MAP kinases are actually a family of protein kinases that are widely distributed and are found in all eukaryotic organisms. These can be classified into three main functional groups. The first is mediated by mitogenic and differentiation signals. The other two respond to stress and inflammatory cytokines.

Now by combining the three inputs, we have (studies in detail, above) made one computational model for cell death / survival shown in Figure 5.

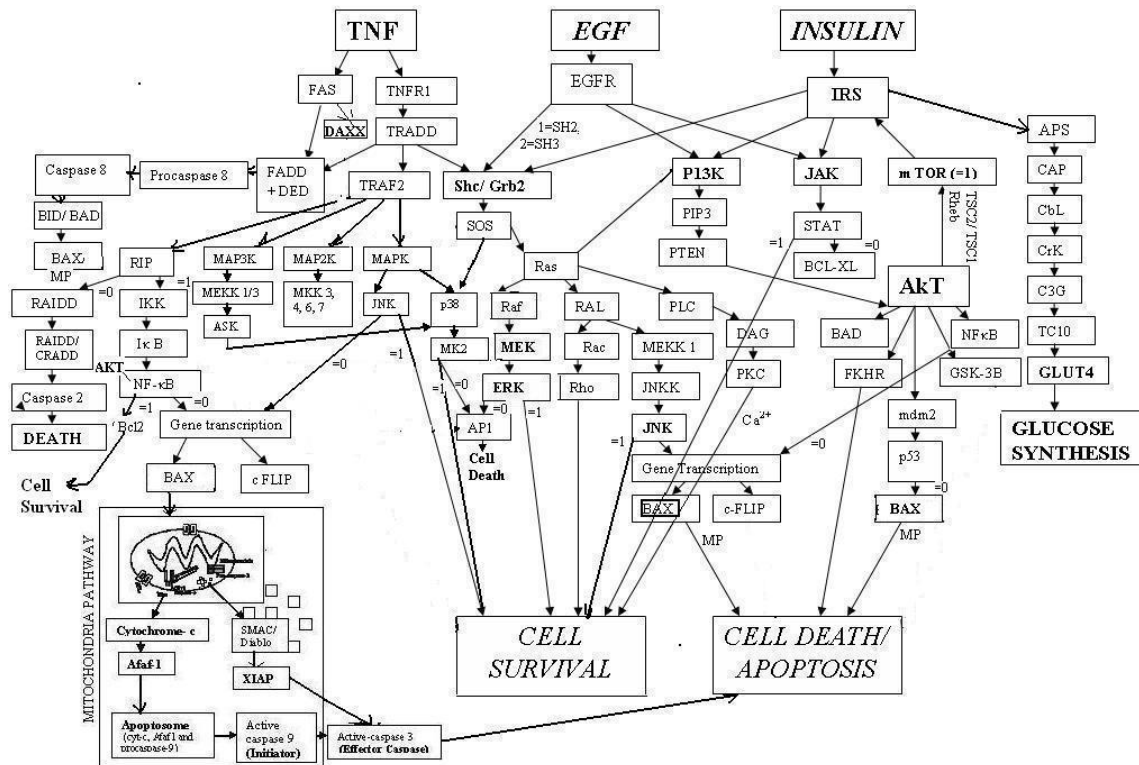

Fig. 5. Computational Model for cell survival/ death.

3. Results and discussions

(a) Experimental findings :

For each experiment, cells were plated at 50,000 cells/cm². After 24 hr, the cells were sensitized by changing to medium supplemented with 200 U/ml IFN γ at a ratio of ~0.13 ml medium/cm². The cultures were stimulated 24 hr later by adding the stimulus diluted in 1/20 of the culture volume of serum-free medium, for final concentrations of 0, 0.2, 5, or 100 ng/ml TNF (Peprotech), 0, 1, or 100 ng/ml EGF (Peprotech), and 0, 1, 5, or 500 ng/ml insulin (Sigma). The C225 anti-EGFR mAb (H.S. Wiley laboratory) and IL-1ra (Amgen) inhibitors were used at 10 μ g/ml. Triplicate plates were lysed at 0, 5, 15, 30, 60, and 90 min and 2, 4, 8, 12, 16, 20, and 24 hr or prepared for flow cytometry at 12, 24, and 48 hr. To explore systematically relationships between cytokine-receptor interaction, activation of intracellular signaling cascades, and apoptosis-survival cell-fate decisions, cells were exposed to a set of ten cytokine treatments and monitored over a 48-hr period. Each treatment consisted of a combination of TNF and either EGF or insulin. Cells respond to TNF, EGF, and insulin in a dose-dependent manner and all three cytokines were therefore examined at subsaturating concentrations, designed to mimic physiological conditions, and at saturating concentrations, at which essentially all receptors were ligand-bound. At 13 time points after cytokine addition, three replicate dishes of cells (six for the zero time point) were harvested to measure kinase activities, changes in protein phosphorylation, caspase cleavage, and changes in protein abundance. All together, 11 protein distinct signals were examined. Five kinases—ERK, Akt, JNK1, IKK, and MK2—were assayed in vitro using microtiter-based immuno complex kinase activity assays. Five phosphorylation sites on four proteins and cleavage of caspases-3 and -8 were measured by quantitative immunoblotting. Phospho-, total, and phospho-to-total (pt) measures of EGFR and Akt were obtained by using antibody arrays. Because kinases such as Akt and ERK were maximally active 5-15 min after cytokine addition whereas caspase cleavage was evident only after 4 hr time points were spaced closely from 0-2 hr (0, 5, 15, 30, 60, 90, 120 min) and then more sparsely from 4-24 hr (4, 8, 12, 16, 20, 24 hr), where $t = 0$ min is the time of cytokine addition. Nonuniform sampling made it possible to measure both early and late signals effectively. To characterize the responses of cells to cytokine combinations, four measures of apoptosis were performed on triplicate

plates 12, 24, and 48 hr after stimulation.

Most variation in the compendium was much larger than this, ranging from 3-fold changes in pEGFR to over 50-fold changes in JNK and MK2 activity. Many of the patterns that could be discerned from the heat map were expected taken by Gaudet et al 2005 (e.g. EGF and insulin significantly inhibited TNF-induced caspase-8 cleavage at $t = 8-24$ hr; $p < 10^{-4}$), but several were unanticipated. In these cases the primary value of the CSR compendium was its ability to put each measured signal within the broader biological context of other signals, treatments, and time points. In addition to visual inspection, the quality of the CSR data enabled us to examine quantitative correlations between cytokines and signals. We applied a previously described statistical mapping technique based on eigen value decomposition and rotation. Briefly, each protein signal in the compendium was integrated over its 24-hr time course and then projected onto a set of classifiers describing the TNF and EGF or insulin treatment. This projection generated a map in which the positions of 11 protein signals were plotted relative to the TNF, EGF, and insulin stimuli. The closer a protein signal is to a cytokine, the more strongly and specifically the signal is activated by that cytokine.

Limitation of Experimental Findings:

1. By using experimental analysis we can evaluate results at 12hr, 24hr and 48 hr only but our model is time independent.

2. In our model we find if P13K, TNFR1, EGFR, IRS, IKK, Grb2, SOS, Ras, TRADD, Traf2 are present then only it will lead to cell survival. If any of the above protein is absent then it will lead to cell death. No such finding is in case with the help of experimental data.

(b) Compendium Model:

Above we had studied relating how TNF, EGF and Insulin work and its pathways in detail and explain each and every possible path for that. Based on pathways we had made truth tables for every possible path for cell survival/death. Then we realize the truth tables by Karnaugh Map (K-Map) and get the Boolean expression for its individual possible paths. We simulate the results of each path, then combine all the results, and simulate through Xilinx and MATLAB simulator, get result of TNF, EGF and Insulin for its cell survival/death. In output, '1' signifies cell survival and '0' signifies cell death. For cell survival the ten different proteins i.e. P13K, TNFR1, EGFR, IRS, IKK, Grb2, SOS, Ras, TRADD, Traf2 should present. If any one of them is absent then there is a cell death.

Figure 6 shows the output signal of cell survival/ death from XILINX simulator considering TNF as input. In figure a[0:9] shows the input for ten proteins which we have mentioned above that should be '1' always for cell survival. b[0:2], c[0:2], d[0:1], e[0:2], f[0:2] and g shows the different pathways related to TNF. B[0:2] means this pathway is three input and all inputs are in form of '0' or '1'. k, l, m, n, o and p shows the outputs of all possible pathways.

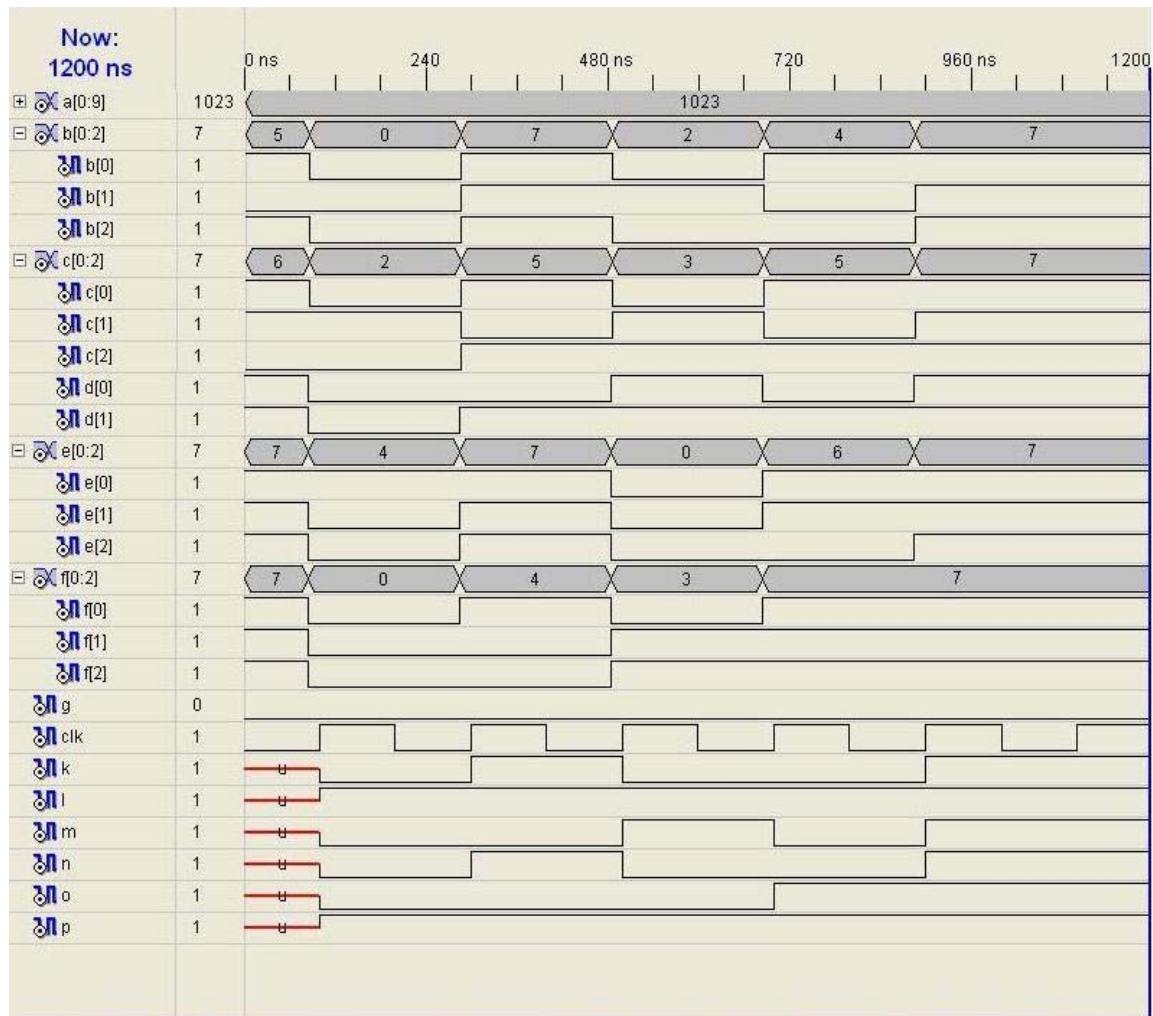

Fig. 6. Output signal of cell survival/ death from XILINX simulation considering TNF as input.

Similarly, Figure 7 shows the output signal of cell survival/ death from XILINX simulator considering EGF as input. b[0:2], c[0:2], d[0:2], e[0:2], f[0:1], g[0:2], h[0:2], i[0:2], u[0:2], w[0:1] as inputs (different pathways) and k, l, m, n, o, p, q, r, s, t and y shows the outputs of all possible pathways.

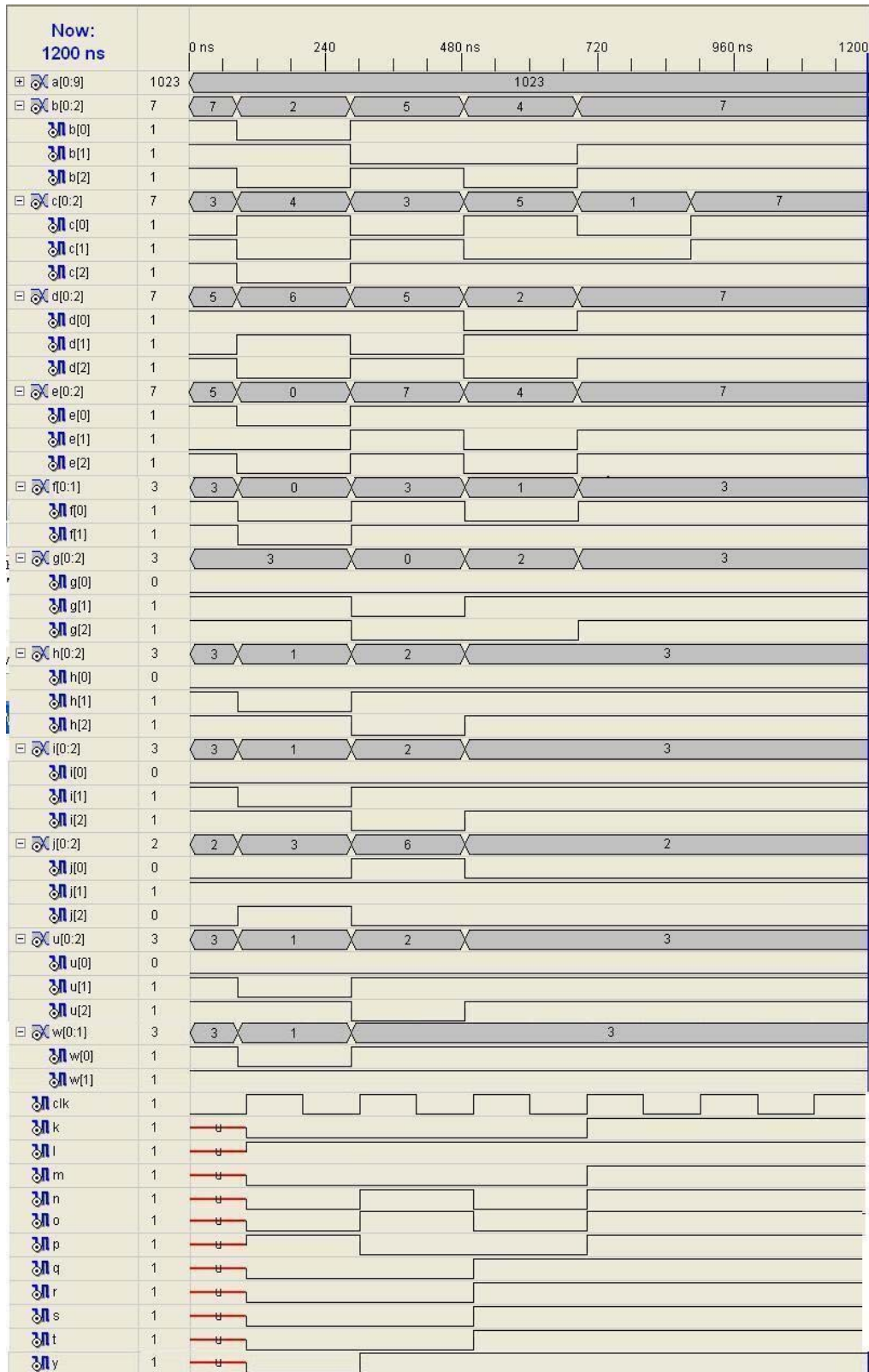

Fig. 7. Output signal of cell survival/ death from XILINX simulation considering EGF as input.

Figure 8 shows the output signal of cell survival/ death from XILINX simulator considering Insulin as input. b[0:2], c[0:2], d[0:2], e[0:2], f[0:1], g[0:2], h[0:2], i[0:2], u[0:2], v[0:2], w[0:1],

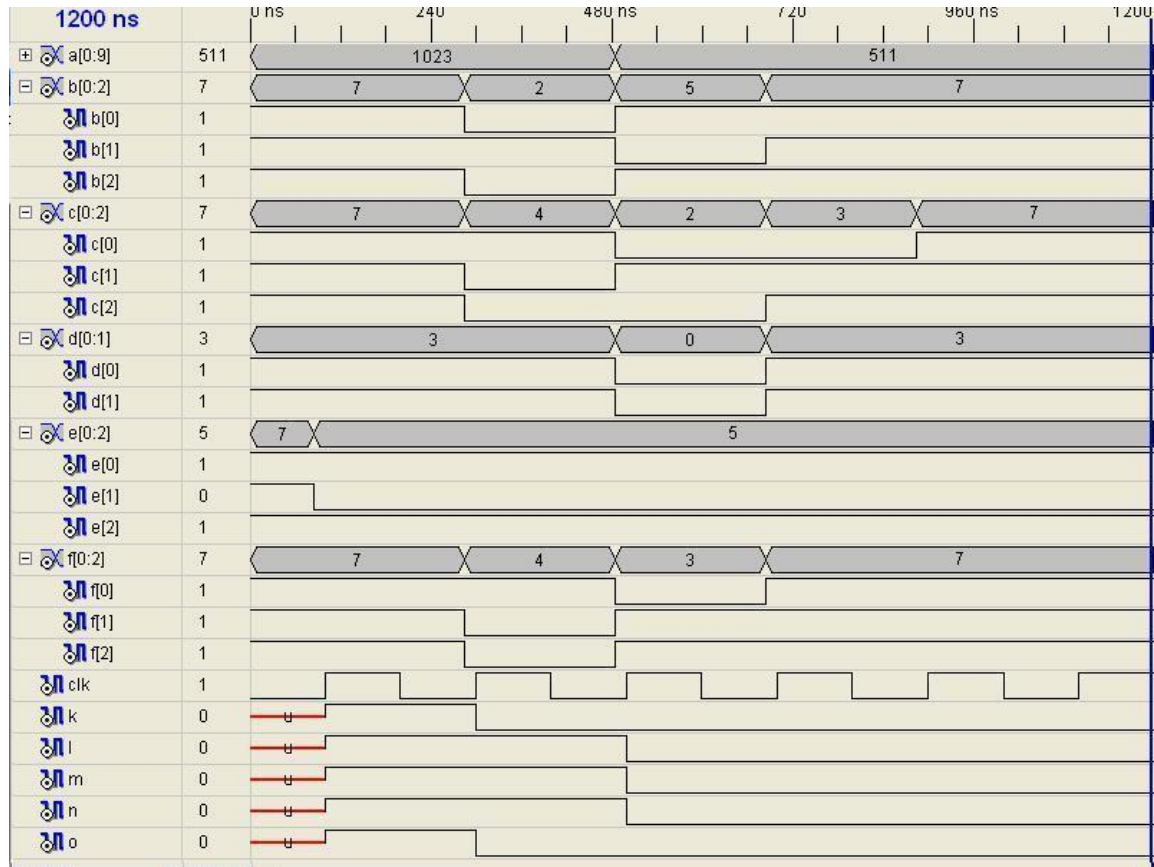

Fig. 9 Output signal of cell survival/ death from XILINX simulation considering TNF, EGF and Insulin as input.

Figure 10, 11, 12 and 13 shows the output using MATLAB of TNF, EGF, Insulin and TNF, EGF and Insulin (combination). Peaks shows '1'.

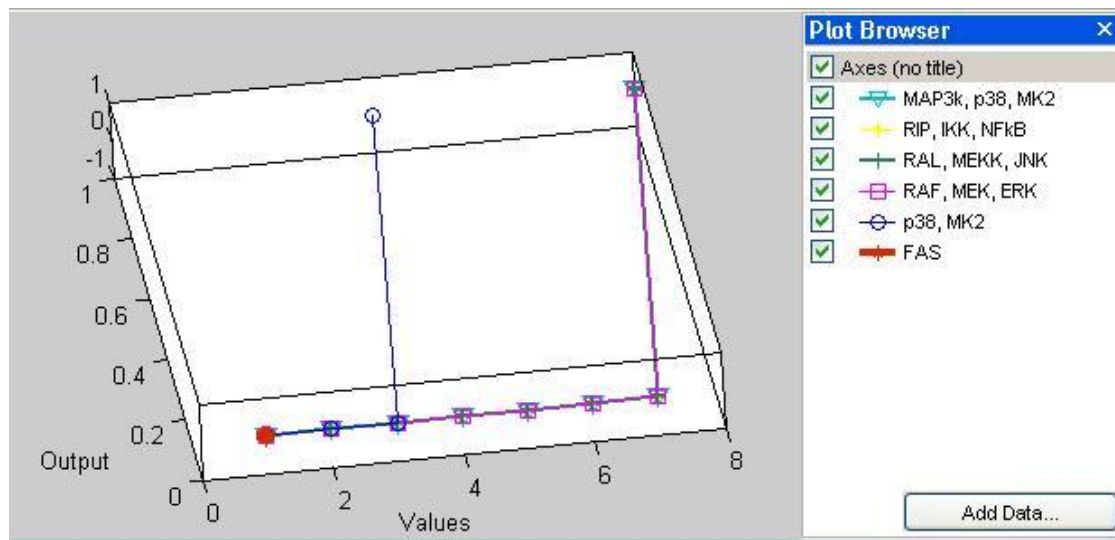

Fig. 10 Output signals of cell survival/ death from MATLAB simulation considering TNF as input.

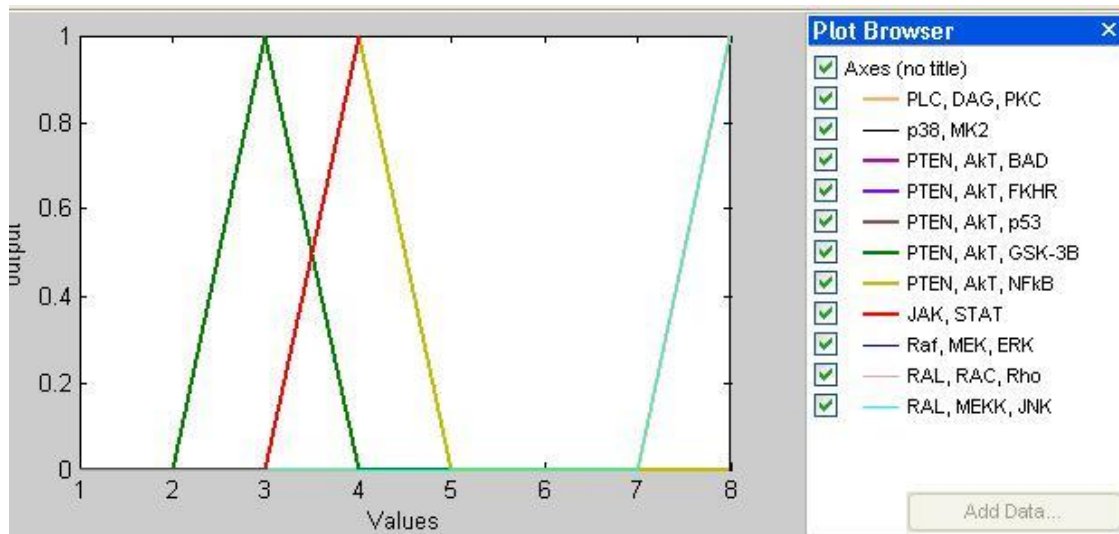

Fig. 11. Output signals of cell survival/ death from MATLAB simulation considering EGF as input.

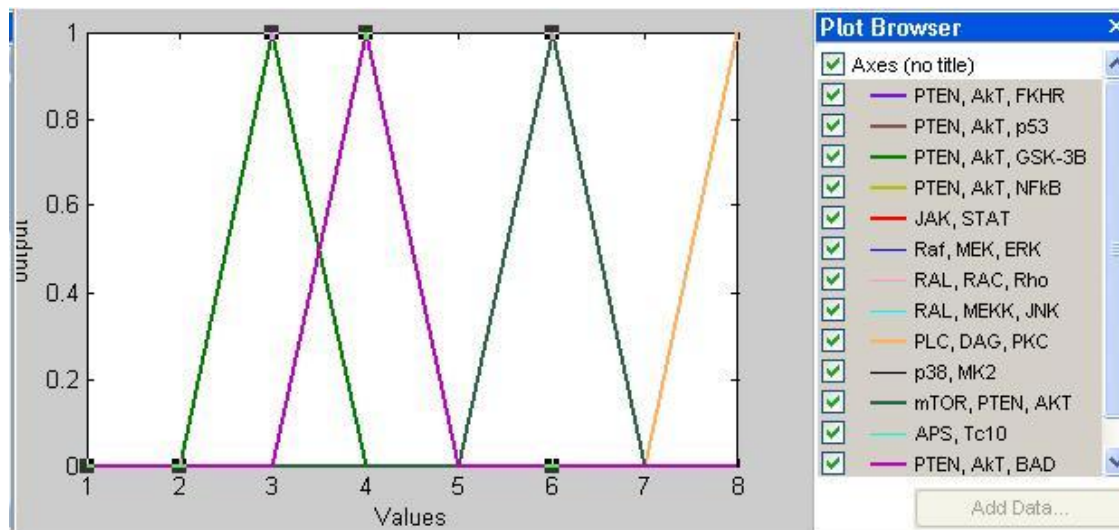

Fig. 12. Output signals of cell survival/ death from MATLAB simulation considering Insulin as input.

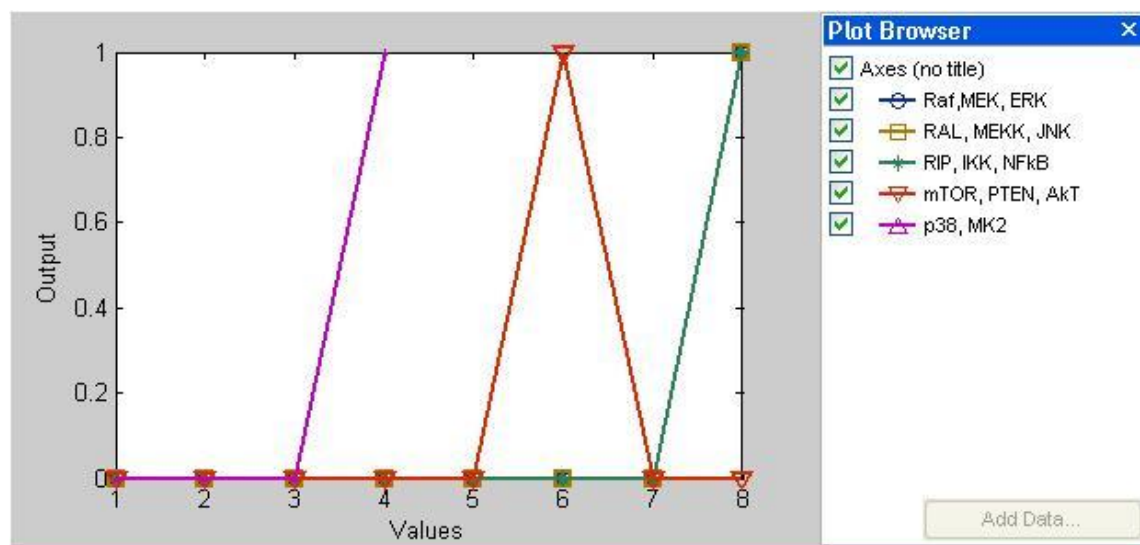

Fig. 13. Output signals of cell survival/ death from MATLAB simulation considering TNF, EGF and Insulin as input.

4. Conclusion

In this paper, we describe the construction and validation of a cytokine-signal-response compendium with which to investigate the regulation of cell fate in cells exposed to combinations of the pro-death cytokine TNF and the pro-survival cytokines EGF and insulin. The compendium contains more than 10,000 biochemical measurements on the states and activities of cell-signaling proteins and apoptotic responses in human cells. At the outset of the work described here it was unclear whether heterogeneous data from immunoblots, antibody microarrays, kinase activity assays, and flow cytometry could be effectively assembled into a single dataset. However, we have now established that a carefully assembled CSR compendium enables the construction of informative statistical models and yields new hypotheses about the regulation of cell fate by cytokines. Elsewhere we describe some specific biological conclusions that can be inferred by mining compendium data; here we concentrate on more general issues associated with the construction, validation and mining of such datasets. A key step in the construction of self-consistent datasets is data fusion. Heterogeneous measurements acquired at different times must be combined in such a way that they can be compared quantitatively across the full dataset. Experimental databases are common in genomics largely because sequence data are homogeneous and structured, with a clear beginning and end, and data fusion is therefore straightforward. In contrast, cell-signaling data are heterogeneous and unstructured, lack an obvious completion point, and depend heavily on biological context. These features make fusion of signaling data challenging. Our approach to building a data compendium started with the definition of an experimental template that was applied repeatedly to the analysis of different cytokine combinations. The template specified standardized experimental protocols and optimized normalization procedures for determining the time-dependent activities of 11 protein signals and 4 cell death responses over a 48-hr period. The template was applied to data collected from cells treated with ten cytokine combinations and two combinations of a cytokine and a receptor inhibitor.

We had successfully made computational model for cell death/ survival using three inputs such as TNF, EGF and insulin With that model we had made truth table, Boolean expression and logical circuit for each possible pathway. We than simulate the results of each path and then combine all the results and get result of TNF, EGF and Insulin for its death/ survival using XILINX and MATLAB.

References

- [1] S. Gaudet, K. Janes , J. G. Albeck ,E. A. Pace, D. A.Lauffenburger, P. K. Sorger, Manuscript M500158-MCP200 (2005).
- [2] K. Janes, A. Kevin , J. G. Albeck, S. Gaudet, P. K. Sorger, D. A.Lauffenburger, M. B. Yaffe, **310**, 1646-1653 (Dec.9, 2005).
- [3] Z. Weixin, PhD thesis, University of Pittsburgh (2006)
- [4] M. Brockhaus, H. J. Schoenfeld, E. J. Schlaeger, W. Hunziker, W. Lesslauer, and H. Loetscher, **87**, 3127-3131 (1990).
- [5] B. Thoma, M. Grell, K. Pfizenmaier, and P. Scheurich, **172**, 1019-23 (1990).
- [6] T. A. Libermann, T. A. Razon, A. D. Bartal, Y. Yarden, J. Schlessinger and H. Soreq, **44**,753-760 (1984).
- [7] N. Normanno, A. De Luca, C. Bianco, L. Strizzi, M. Mancino, M. R. Maiello, A. Carotenuto, G. De Feo, F. Caponigro, D. S. Salomon, **366**, 2–16 (2006).
- [8] J. M Lizcano. D. R. Alessi, **12**, 236-238 (2002).
- [9] M. F. White, **40**, S2–S17 (1997).
- [10] M. F. White, **302**, 1710–1711 (2003).
- [11] G. Pearson, F. Robinson, G. T. Beers, B. E. Xu, M. Karandikar, K. Berman, M. H. Cobb, **22**(2),153-83 (2001).
- [12] G. Zhou Z. Q. Bao, J. E.Dixon, **270** (21), 12665–9 (1995).

- [13] P. A. Evers, M. Craxton, N. Morrice, P. Cohen, M. Goedert, **5**(6) 321–328 (1998).
- [14] D. T. Dudley, L. Pang, S. J. Decker, A. J. Bridges, A. R. Saltiel, **92**(17):7686–7689 (1995).
- [15] N. K. Sah, T. K. Taneja and S. E. Hasnain, 74-84(2000).
- [16] C.X. Lu, T.J. Fan, G.B. Hu, and R.S. Cong, **35**, 881–885(2003).
- [17] J. Lotem, **4**, 187–196 (1999).
- [18] V. Katrien, D. R. Van Bockstaele, Z. N. Berneman, **84**, 627-639(2005).
- [19] T. Jelinek, A. D. Catling, C. W. Reuter, S. A. Moodie, A. Wolfman and M. J. Weber, **14**, (12) 8212-8218 (1994).
- [20] B. Hallberg, S. I. Rayter and J. Downward, **269**(6), 3913-3916 (1994).
- [21] K. Dohoon and C. J. Jongkyeong, **35** No. 1 106-115 (2002).
- [22] A. Laura, B. Paola, P. Marcella and A. **50**, 545-549. (2004).
- [23] T. Kisseleva, S. Bhattacharya, J. Braunstein, C. W. Schindler, **285**, 1-24 (2002).
- [24] B. A. Hemmings, **275**, 628–630 (1997).
- [25] D.R. Alessi, M. Andjelkovic, B. Caudwell, P. Cron, N. Morrice, P. Cohen, and B. A. Hemmings, **15**, 6541–6551(1996).
- [26] W. Ogawa, T. Matozaki, M. Kasuga, **82**, 13-22 (1998).
- [27] D. Schmoll, K. S. Walker, D. R. Alessi, R. Grempler, A. Burchell, S. Guo, R. Walther, T. G. Unterman, **275**, 36324-36333 (2000)..
- [28] L. Asnaghi, P. Bruno, M. Priulla, A. Nicolini, **50**, 545-549 (2004).
- [29] A. Barthel, D. Schmoll, K. D. Kruger, G. Bahrenberg, R. Walther, R. A. Roth, H. G. Joost, **285**, 897-902 (2001).
- [30] H. H. Wallberg, S.H. Constable, D.A. Young, and J.O. Holloszy, **65**, 909–913(1988).
- [31] L. JeBailey, A. Rudich, X. Huang, C. Di Ciano-Oliveira, A. Kapus, and Klip, **18**, 359–372 (2004).

Abbreviations

AP-1, Activation Protein 1; ASK1, Apoptosis signal-regulating kinase 1; EGF, epidermal growth factor; EGFR, epidermal growth factor receptor; ERK, extracellular-regulated kinase; FADD, Fas-Associated protein with Death Domain; FKHR, Forkhead transcription factor; GLUT4, Glucose transport; Grb2, growth factor receptor-bound 2; GSK 3, Glycogen synthase kinase 3; HOG, High osmolarity glycerol; IGF, insulin-like growth factor; I κ B, I Kappa B (nuclear factor of kappa light polypeptide gene enhancer in B-cells inhibitor); IKK, I κ B kinase; IR, insulin receptor; IRS1, insulin receptor substrate 1; JNK1, c-jun NH₂ terminal kinase 1; MAP kinases, mitogen-activated protein kinases; MATLAB, Matrix Laboratory; MEK, mitogen-activated protein kinase and extracellular-regulated kinase kinase; MK2, mitogen-activated protein kinase-activated protein kinase 2; mTOR, mammalian target of rapamycin; NF- κ B, nuclear factor- κ B; PDK, Phi Delta Kappa; PI3K, phosphatidylinositol 3-kinase; p38, P38 mitogen-activated protein kinases; pT-EGFR, phospho-to-total EGFR; pT-Akt, phospho-to-total Akt; Rac, Ras-related C3 botulinum toxin substrate; SAPK/JNK, Stress-activated protein kinase/Jun-amino-terminal kinase; SH2, Src homology 2; SODD, Silencer of death domains; SOS, Son of Sevenless; TNF, tumor necrosis factor; TNFR1, tumor necrosis factor receptor 1; TNFR2, tumor necrosis factor receptor 2; TRADD, TNFR associated via death domain; TRAF2, TNF receptor associated factor 2, VHDL, Very High Speed Integrated Circuit Hardware Description Language; VLSI, Very Large Scale Integration; XIAP, X-linked Inhibitor of Apoptosis Protein;