

DESIGN AND ANALYSIS OF GRAVITY DAM

A

PROJECT REPORT

Submitted in partial fulfillment of the requirements for the award of the degree

of

BACHELOR OF TECHNOLOGY

IN

CIVIL ENGINEERING

Under the supervision

of

Dr. Saurav

(Assistant Professor)

by

Deval (181661)

Nikhil Sharma (181659)

to



JAYPEE UNIVERSITY OF INFORMATION TECHNOLOGY

WAKNAGHAT, SOLAN – 173234

HIMACHAL PRADESH, INDIA

MAY – 2022

STUDENT'S DECLARATION

We hereby declare that the work presented in the Project report entitled “**Design and Analysis of Gravity Dam**” submitted for partial fulfillment of their requirements for the award of the degree of Bachelor of Technology in Civil Engineering at **Jaypee University of Information Technology, Wagnaghat** is an authentic record of our work carried out under the supervision of **Dr. Saurav**. This work has not been submitted elsewhere for the reward of any other degree/diploma.

We are fully responsible for the contents of our project report.

Deval

181661

Department of Civil Engineering

Jaypee University of Information Technology

Wagnaghat, India

Date –

Nikhil Sharma

181659

Department of Civil Engineering

Jaypee University of Information Technology

Wagnaghat, India

Date –

CERTIFICATE

This is to certify that the work which is being presented in the project report titled **“Design and Analysis of Gravity Dam”** in partial fulfillment of the requirements for the award of the degree of Bachelor of Technology in Civil Engineering submitted to the Department of Civil Engineering, **Jaypee University of Information Technology, Wagnaghat** is an authentic record of work carried out by **Deval (181661) and Nikhil Sharma (181659)** during a period from August, 2021 to May, 2022 under the supervision of **Dr. Saurav**, Department of Civil Engineering, Jaypee University of Information Technology, Wagnaghat.

The above statement made is correct to the best of our knowledge.

Date:

Dr. Saurav
Assistant Professor
Civil Engineering Department
JUIT, Wagnaghat

Prof. (Dr.) Ashish Kumar
Professor and Head
Civil Engineering Department
JUIT, Wagnaghat

ACKNOWLEDGMENT

Firstly, we must express our very profound gratitude to all the mighty GOD, our parents for providing us with unfailing support and continuous encouragement throughout the project. We would like to thank everyone who has helped in every possible way in successful completion of this project. Firstly, we would like to express our gratitude to our project guide **Dr. Saurav**, who provided us an opportunity to do this project under his guidance. He has provided his support and valuable ideas during the course of the work. This work would have been impossible without his support and true participation in every problem that occurred during the completion of this project. We would like to place our best regards to the coordinator and all other faculty members and technical staff of the Department of Civil Engineering of Jaypee University of Information Technology for providing valuable input throughout the course of this work. We are highly grateful to our institute **Jaypee University of Information Technology** for providing us the opportunity and space for the completion of our project.

ABSTRACT

Gravity dams are life-saving megastructures that are frequently utilised for irrigation, hydroelectric power generation, water supply, and aquatic animal augmentation, among other things. The concrete gravity dams must maintain their stability by employing their own weight. When the concrete gravity dam is tested for stability and seismic pressure, the material's strength is critical. This basically do the evaluation of stability of gravity dam via the use of STAAD. Some traditional and some professional approaches A gravity dam is a sturdy structure made of concrete or masonry that is constructed in the course of a river to create a reservoir upstream. The gravity dam's phase is roughly triangular in shape, with the peak at the pinnacle and the maximum width at the bottom. The phase is proportioned in such a way that it resists the various forces acting on it by utilising its own weight. In this work, a dam evaluation is carried out using the STAAD. Pro software application. STAAD seasoned is particularly well-suited to multi-story homes with beams and columns. STAAD. Pro, on the other hand, can detect any type of detail, such as plate, shell, or robust, in the same way that beam members can. Dam is thus modelled with robust components in the software programme software with adequate data. Stress contours and their results are defined on the paper's website. The purpose of this research is to provide a method of dam evaluation based on resilient criteria and the use of STAAD.

TABLE OF CONTENTS

	Page Number
STUDENT'S DECLARATION	ii
CERTIFICATE	iii
ACKNOWLEDGEMENT	iv
ABSTRACT	v
LIST OF TABLES	viii
LIST OF FIGURES	ix-x
CHAPTER – 1	
INTRODUCTION	1
1.1 INTRODUCTION TO GRAVITY DAM	2-3
1.2 DESIGN OF CONCRETE DAM SECTION	4-5
1.3 INTRODUCTION TO SOFTWARE	5
CHAPTER – 2	
LITERATURE REVIEW	6-10
1.4 OBJECTIVES	10
CHAPTER – 3	
METHODOLOGY	11
3.1 LOAD CONSIDERED	13-14
3.2 GENERAL	15
3.3 TYPES OF STRUCTURES	15
3.4 GENERATION OF THE STRUCTURES	16
3.5 SUPPORTS	16
3.6 LOADS	16-17
3.7 SECTION TYPE OF CONCRETE DAM	18
3.8 DESIGN PARAMETERS	18-23

3.9 DESIGN STEPS IN STAAD.PRO	24-25
CHAPTER – 4	
DESIGN FOR CONCRETE DAM	26
4.1 DESIGN OF CONCRETE DAM SECTION	27-28
4.2 CALCULATIONS	29-32
4.3 DESIGN IN STAAD.PRO	33-46
CHAPTER – 5	
RESULTS & DISCUSSIONS	47
TABLES & RESULTS	51
CHAPTER – 6	
CONCLUSION	52-54
REFERENCES	55-58

LIST OF TABLES

Table Number	Caption	Page Number
4.1	Analysis of Gravity Dam	38
4.2	Displacement Values	39
4.3	Moment Values	41
4.4	Node Displacement	46
5.1	Results	51

LIST OF FIGURES

Figure Number	Caption	Page Number
1.1	Gravity Dam	3
2.1	Forces Acting on a Gravity Dam	9
3.1	3-D Construction of the Dam	33
3.2	Plan of the Dam	33
3.3	Elevation of the Dam	34
3.4	Support Area in STAAD	34
3.5	Geometry of the Dam	35
3.6	Piping Geometry	35
3.7	Piping Assignments & Dead Load Conditions	36
3.8	Load Assignments IS Codes	36
3.9	Analysis Input Data Assignments	37
3.10	Displacement	38
3.11	Bending	39
3.12	Displacement Along Axis	40
3.13	Displacement Condition for Load Assignment	40
3.14	Torsion and Shear	41
3.15	Post-Processing	42
3.16	Membrane and Bending	42
3.17	Moment along Z	43
3.18	Shear Force along Y-direction	43
3.19	Shear Force along X-direction	43
3.20	Wind Direction along X	44
3.21	Wind Direction along -X	44
3.22	Wind Direction along Z	45

3.23	Wind Direction along -Z	45
3.24	Live Load Analysis	46
5.1	Bending Moment	48
5.2	Shear Force	48
5.3	Axial Force	49
5.4	Deflection	49
5.5	Soil Stress in X-Direction	50
5.6	Soil Stress in Y-Direction	50
5.7	Soil Stress in Z-Direction	50

CHAPTER – 1
INTRODUCTION

1.1 Introduction to Gravity Dam

Dams created out of expertise concrete and which rely simply upon its self-burden for sufficiency falls beneath the characterization of gravity dams. Masonary dams were being applied in beyond automatically but after opportunity, very last vital block paintings dam shape that turned into constructed turned into Nagarjunsagar. Dam on circulate Krishna which turned into labored among 1958-69. paintings turned into used which turned into supported collectively via lime concrete or robust concrete. In any case block paintings dam is completed being organized in our the us probably in moderate of essence of opportunity viably open dam development cloth and want development development. Truly, gravity dams are as of now being labored of mass robust, whose association and development factors can be referred to on this part. There are severa dams labored out of robust much like the Curve/Different Curve or Brace kind. These have in any case now no longer been organized or inherent India, besides for the only one being the bend dam at Idukki on circulate Periyar. In India the instance for robust dam is really of the gravity kind and as it want to be the association severa types of robust dams have now no longer been referred to on this direction. It is crucial to look that, it isn't always in fact correct enough to plot a robust dam shape, at any fee it's miles fairly critical to test the recognition quo too for key uprightness. For robust dams, the squeezing detail made on the intersection trouble of the bottom subsequently sooner or later finally ends up being uncommonly high, which the recognition quo has to resist. Usually, concrete gravity dams are built throughout a river via excavating a manner the unfastened overburden until company stone is in a function that is taken into consideration because of the reality the certifiable recognition quo. Everything taken into consideration now no longer all stones are of a comparable quality; they range with severa land substances and the cycle via which they were laid out at some stage withinside the extended stretch. For instance, the dispositions of the Himalayan diploma of the mountains are appeared as topographically youthful, comparably as more fragile than the massif of the Deccan stage. The opportunity of recognition quo now no longer in fact consequences the sport plan, it similarly controls the shape of dam that could be healthy at a direction of movement site. Subsequently, conversations at the floor recognition quo factors of view were furnished on this motion as well.



Fig. 1.1: Gravity Dam

[1] (<https://upload.wikimedia.org/wikipedia/commons/6/6a/Willowcr.jpg>)

1.2 Design of Concrete Gravity Dam Sections

Fundamentally a gravity dam need to fulfill the subsequent criteria:

1. It can be solid in the direction of overturning at any horizontal feature in the dam at the touch with the inspiration or withinside the muse.

2. It need to be solid in the direction of sliding at any horizontal aircraft in the dam, at the touch with the inspiration or alongside any geological characteristic in the foundation.

3. The section need to be so proportional that the allowable stresses in each the concrete and the inspiration need to now not exceed. Safety of the dam shape is to be checked in the direction of viable loadings, which can be categorized as primary, secondary or exceptional. The beauty is made in phrases of the applicability and/or for the relative significance of the load.

1. Primary hundreds are diagnosed as universally relevant and of excessive significance of the load.

2. Secondary hundreds are usually discretionary and of lesser significance like sediment load or thermal stresses due to mass concreting.

3. Exceptional loads are designed on the basis of limited favored applicability or having low threat of prevalence like inertial loads associated with seismic activity. Technically a concrete gravity dam derives its stability from the stress of gravity of the materials withinside the section and as a end result the name. The gravity dam has sufficient weight which will face up to the forces and the overturning 2nd because of the water impounded withinside the reservoir withinside the returned of it. It transfers the loads to the guidelines with the resource of the use of cantilever action, as a end result correct foundations are pre considered necessary for the gravity dam.

The forces that deliver balance to the dam include:

1. Weight of the dam

2. Thrust of the tail water

The forces that attempt to destabilize the dam include:

1. Reservoir water stress

2. Uplift
3. Forces because of waves withinside the reservoir
4. Ice stress
5. Temperature stresses
6. Silt stress
7. Seismic forces
8. Wind stress

The forces to be resisted via way of approach of a gravity dam fall into training as given below:

1. Forces, together with weight of the dam and water stress which may be straight away calculated from the unit weight of substances and homes of fluid stress and
2. Forces together with uplift, earthquake loads, silt stress and ice stress which may be assumed first-rate on the idea of assumptions of numerous diploma of reliability. In truth to assess this beauty of forces, particular care need to be taken and reliance positioned on to be had data, enjoy and judgement.

1.3 Introduction to Software

STAAD. Pro is today the most widely used software tool in the civil engineering field. This software is particularly extraordinary and include rich than AutoCAD, which is another well-known programming in the development field. AutoCAD permits a client to deal with measurements just in little detail. Then again, STAAD. Pro permits the client to deal with 3D or three-dimensional models in generous detail. STAAD. Pro significantly lessens your manual computation and time as -well.

CHAPTER – 2
LITERATURE REVIEW

IIT, Kharagpur (2010) extensively classified dams in keeping with production substances. The type is as follows;

1) Embankment dams - These are dams built of herbal substances excavated & acquired from the location of a dam site. The primary varieties of embankment dams include:

2) Earth-stuffed dams – This dam makes use of compacted soil for building the bulk weight of the dam. It is built primarily with the aid of using choosing engineering soils compacted equally and intensively in thin layers at a managed moisture content. This dam can be homogeneous in which most effective one type of soil is to be had and the dam peak is low or can be zoned in which extra than one sort of soil fabric is used. They are the maximum within your budget sort of dam and utilizes substances, commonly to be had locally, that do now no longer require a excessive diploma of processing. However, those dams are highly prone to erosion and require steady maintenance. Also, soil uploading can be required if the soils in the vicinity or now no longer clay soils.

3) Concrete dams – Use of a lot of concrete in dam built commenced because of the benefit of production and to fit complicated designs, like having a spillway inside the dam body. Mass concrete may be bolstered with the aid of using the use if components like slag, gasoline ash in order to lessen temperature induced troubles or keep away from unwanted cracking and overall value of the project. Types of concrete dams include:

i) Arch dams – those varieties of dams have extensive upstream curvature in plan and depend upon an arching motion on the abutments thru which of the water hundreds is surpassed onto the partitions of the river valley

ii) Buttress dams – those kinds of dams encompass a non-stop upstream face supported at everyday periods via way of means of buttress partitions and the downstream side.

iii) Gravity dams – A gravity dam is one which relies upon absolutely on its personal weight for stability. It can be built of masonry or of concrete. Other classifications of dams include;

2.1 Based on characteristic and use

(i) Storage dams (or conservation) dams: These are dams constructed to keep greater flood water at a few degree withinside the moist season on the equal time as there is a large drift withinside the river to be implemented later at a few degree withinside the duration on the equal time because the drift withinside the river is reduced and is an awful lot an entire lot a great deal much less than the demand. The water stored withinside the reservoir long-mounted withinside the upstream is used for a number of purposes, together with irrigation, water supply and hydropower.

(ii) Diversion dam: A diversion dam is constructed for the purpose of raising the water diploma and divert water of the river into an off-taking canal (or a conduit) or a conveyance machine wherein it is able to be used as run-off river hydroelectric scheme, water supply or irrigation.

2.2 Hydraulic design

(i) Overflow dams: An overflow dam is mainly designed to behave as a overflow structure. The surplus water which can't be retained withinside the reservoir is authorized to thru way of approach of byskip over the crest of the overflow dam which acts as a spillway. The overflow dam is crafted from a material along thing masonry or cement concrete which does now now not erode thru manner of manner of the movement of overflowing water.

(ii) Non-overflow dams: A non-overflow dam is designed such that there's no waft over it. Excess water isn't allowed to waft over the pinnacle of the dam and a separate spillway away from the frame of the dam is furnished to dispose of the extra flood water. The technique is as mentioned below;

i) Collect the circulation float records at the reservoir web website online for the duration of the essential dry period. Generally, the month-to-month influx prices are required. However, for very big reservoirs, the annual influx prices can be used.

ii) Ascertain the release to be launched downstream to satisfy water rights.

iii) Determine the direct precipitation quantity falling on the reservoir for the duration of the month.

iv) Estimate the evaporation losses which could arise from the reservoir. The pan evaporation records are normally used for the estimation of evaporation losses for the duration of the month.

v) Ascertain the call for the duration of diverse months.

vi) Determine the adjusted influx for the duration of one-of-a-kind months as follows:

$$\text{Adjusted inflow} = \text{Stream inflow} + \text{Precipitaion} - \text{Evaporation} - \text{Downstream discharge}$$

vii) Computation of the garage potential for each month.

$$\text{Storage required} = \text{Adjusted inflow} - \text{Demand}$$

The garage could be required best in the one's months in which the call for is much less than the adjusted influx.

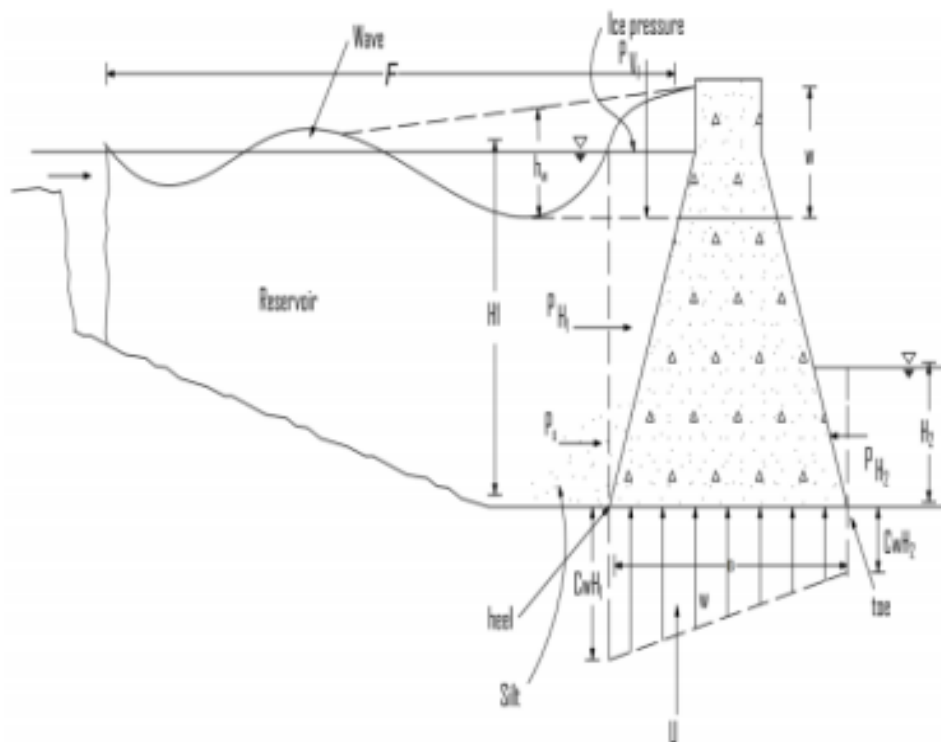

Fig. 2.1: Forces Acting on a Gravity Dam

[2] Anveshna'S International... Journal.. of Research... and Engineering..

2.3 Design specifications

Design specifications

Height of the dam = 90mts

Length = 50mts

Base width = 85 mts

Concrete grade = M40

Steel grade = FE500

Road width = 10mts

Water flow distance = 10mts

2.4 Objectives

1. Method to calculate essential duration and layout base shear.
2. Vertical distribution of base shear alongside the peak of the dam.
3. To examine the dam through the use of staad.pro.

CHAPTER – 3
METHODOLOGY

STAAD or (STAAD. Pro) is a structural evaluation and layout pc software to begin with advanced via Research Engineers International in Yorba Linda, A. In past due 2005, Research Engineer International changed into provided via Bentley Systems. An older model known as STAAD-III for home domestic home windows is utilized by Iowa State University for educational capabilities for civil and structural engineers. The business model STAAD. Pro is one of the most importantly used structural evaluation and layout software. It also can hire numerous types of dynamic evaluation from modal extraction to time information and reaction spectrum evaluation. The dam frame is modeled in STAAD.pro the usage of the strong iso-parametric finite factors with 8 nodes. Each node has 3 translational stages of freedom. The stiffness matrix of the strong detail is evaluated via numerical integration with 8 Gauss – Legendre points. The dam is analyzed for numerous smooth masses and load mixtures possibly met with all through its service. These are enlisted in table 1 beneath. The stresses precipitated are checked for all of the mixtures and the size are so framed that the element of protection referred to above is maintained. The base of the dam is to relaxation on rock and the more excavation into be complete of concrete of same strength, the concept rock of about same to the height of dam is modeled round and beneath the concept level. The gift have a look at undertaken offers with time information approach of dynamic analysis. Time information is to be had first-rate for X direction, so as a way to observe forces in certainly considered one among a type angles, the shape desires to be have become spherical with prevalence mindset from zero to 90 stages, with an increment of 10 stages and column forces had been investigated in all cases. Further as a way to locate the suitable c language of one degree is used. The columns had been divided into 3 crucial categories, which includes corner, facet and internal columns and the effects are compared.

3.1 Load Considered

3.1.1 Dead Load

The Dead Load involves the heaviness of the solid design of the dam body not with-standing dock doors and extensions, if any ludicrous. Cement's thickness is assessed to be 2400 kg/m³.

3.1.2 Primary Load

a. Water Load: - The dam's u/s and d/s faces are subjected to water pressure. The most overturning force acting on a gravity dam is the pressure of the water on the u/s face. Stability is aided by the tailwater pressure. The tail water pressure is modest in comparison to the water pressure on the u/s fore-head. To the surface, the water pressure is still natural. It is easier to compute the components of factors at work in the horizontal and vertical directions rather than the overall force on the inclined surface explicitly when calculating the forces due to water pressure on an inclined surface. Water pressure forces are discussed separately for non-overflow and portion and overflow sections below;

3.1.3 Secondary Load

Wave Pressure (hydrodynamic wave load): Swirling winds produce waves on the reservoir's top, causing pressure to shift to the d/s side. The highest point of the waves determines the wave pressure.

3.1.4 Seepage Load

The uplift is designed to affect the entire foundation width.

3.1.5 Wind Load

When the dam is full, wind acts simplest at the downstream facet accordingly contribute to stability.

3.1.6 Exceptional Loads

Under reservoir entire conditions, the most unfavourable seismic loading will then arise even as a ground wonder is associated with: – Horizontal foundation acceleration running upstream, an– Vertical foundation acceleration running downwards.

3.2 General

The STD input document is the manner by which the GUI (or Graphical User Interface) interfaces with the STAAD.pro research motor. The info document is a book record that contains a bunch of orders that are run all together. The orders either give guidelines or information about examination and additionally design. A content tool or the GUI Modeling office might be utilized to produce the STAAD input design. Any content manager can be utilized to alter/make the STD input record by and large. The info record is produced by the GUI Modeling office utilizing a vivid menu-driven designs arranged.

3.3 Type of Structures

A plan can be divided into several sections. STAAD. Pro is ready to investigate and arrange structures made out of packing, plates/shells, and solid parts. Almost every arrangement can be found destitute someplace near STAAD. Professional programming. The most common way to go aboard an aircraft is by a space structure, which is a three-dimensionally drawn out plan with loads applied in any plane. Structures made of truss people can have lately critical part controls and no curvature in the people. A tale structure is a two dimensional development with no overall (X or Z) plan improvement [FX, FZ, and MY are controlled at each joint]. The overall XZ plane of a design's floor layout is an ideal illustration of a story structure. s longas the development does not have level stacking, portions can be displayed with the floor in narrati ve structure. If there is any even weight, it should be decomposed as a space structure.

3.4 Generation of the Structure

The layout is probably constituted of the information file or referencing the co-ordinates withinside the GUI. The determine under indicates the GUI age strategy.

3.5 Supports

Support is represented as Stuck, FIXED, or FIXED and has a variety of promotions (but called FIXED). Stack support has a limit on every translation turn of the event, not a limit on the rotation turn of the event. With everything in mind, the stubborn willingness to support a reaction to all forces is no less than a minute. Firm support has limits in all directions of ascent. In addition, it can represent translational and rotary springs. The spring is tensioned according to the spring constant. A translational spring support is described as the ability to remove a support joint by a unit length up to a given total distance. Torsion spring support is also expressed as the ability to rotate the support joint once around a given overall course.

3.6 Loads

You can specify joint loads, beam loads, temperature loads, and loads to which the end bar of the structure is permanently attached. STAAD is an acronym for Standardized Transportation Authority. In addition, Pro calculates the weight of the structure and uses it in the analysis as a uniformly distributed element load. Any part of this weight can be directed in any direction.

3.6.1 Joint Loads

Each loose joint in the device can be exposed to hundreds of joints, including all forces and moments. Hundreds of these work according to the structure's global coordinate system. Nice coordinate defaults are afflicted by nice forces. Hundreds of joints can be associated with unmarried joints, and hundreds can be added to those joints.

3.6.2 Member load

3 Various partial loads can be applied directly to a person from a structure. These stacks are reliably acquired loads, concentrated weights, and moved straight weights (trapezoidal test). Uniform weights draw a circle with unlimited or inadequate section length. The collected issues work at a moderately determined point. Easily changing the weights makes the section length absurd. The trapezoidal straight alternating weights work at the full length of the section or the middle length. Trapezoidal weights are converted to unit weights and some concentrated weights. Many weights can be displayed back to any free-stacked section. Part loads can be viewed in part assembly structures or total work in the system. A stack of reliable ordered parts that has been proven to work over the full length or expected length of the parts in a global sort structure.

3.6.3 Area / Floor Load

A uniformly allotted load is likewise carried out to a floor (bounded with the aid of using the X-Z plane). Calculating the member load for every floor's person contributors may take a long time. Using the AREA or FLOOR LOAD commands, the person may also outline the area loads (unit load in keeping with unit rectangular area) for contributors. For those participants, the software program willdegree the tributary place and calculate the right person loads. One-manner

distributions are dealt with the aid of using the Area Load, and two-manner distributions are dealt with the aid of using the Floor Load.

3.7 Section Types of Concrete Dam

Concrete members may be constructed for there are various precise varieties of cross sections. Prismatic Beams for (Rectangular) Prismatic Columns (Rectangular)

3.8 Design Parameters

A variety of parameters are covered withinside the software program which might be wanted for IS 13920 architecture. It accepts all the parameters required for IS: 456 architecture. It additionally has a few extra standards which might be best to be had when the layout is finished in line with IS: 13920. The default parameter values had been selected to be numbers which might be frequently discovered in conventional architecture specifications. This guide consists of a complete listing of the to be had parameters in addition to their default values, which may be changed to accommodate the particular layout being done. Before starting the concrete plan, the duration and pressure devices have to be declared in milli-meters and Newtons.

3.8.1 Beam

Arrangement Pillars are deliberate for flexure, shear and curve. At something point required the impact of the middle pressure can be considered. For all of those forces, all particular bar loadings are pre sifted to understand the crucial weight instances at one-of-a-kind areas of the shafts. For layout to be persisted via way of means of IS: 13920 the width of the element may not be below 200mm. Similarly, the element will in a great international have a width-to importance quantity of greater than 0.3.

3.8.2 Design for Flexure

The planning approach is the same as the IS456 approach. Whether or not you can agree on the next action through IS13920:

1. The concrete baseline rating would be the ideal International M20.
2. Steel fortresses rated Fe415 or less can be used.
3. The volume of base metal of the invading element on both sides and each part is given by the following method.
4. $P_{min.} = 0.24\sqrt{fckfy}$
5. A comfortable volume of metal in any face, any cut, given at $P_{max} = 0.02$.
6. In any case, a good amount of metal in a common area should cover most of the bad metal in that area.
7. All vertices and bases, all fragments, all charge-yielding metals are equivalent to a quarter of the satisfying, unfortunate second metal released at the entity of both junctions. To do.

3.8.3 Design for Shear

The IS 13920:1993 revision specifies the shear force that vertical hoops must resist. When measuring shear power, elastic sagging and hogging moments of resistance of the beam section at ends are taken into account. Plastic drooping and hoarding snapshots of opposition can likewise be utilized for shear plan if the PLASTIC boundary is characterized in the information document. Shear support is utilized to oppose torsional and shear powers.

3.8.4 Column Design

Sections are proposed for considerable forces and biaxial mins in step with IS-456:2000. Portions are in addition proposed for shear powers. All vital fashions for picking longitudinal and recover from assist as decided through IS: 456 had been controlled in the segment plan of STAAD. Pro anyway following prerequisites had been happy to unite publications of motion of IS 13920:

1. The basic rating of concrete is as M20
2. Steel fortresses rated below Fe415 can be used.
3. The base area of the area element must be at least 200 mm. For segments with an unsupported period greater than 4 m, the maximum fragment length must be at least 300 mm.
4. For super globals, the volume of the shortest section estimate for the opposite estimate is always 0.
5. The pitch of the circle should not exceed most of the maximum lateral phase of the component, except when anomalous prohibition assistance is provided.
6. Unprecedented prohibition support can be given over a period of 100 from any articular surface towards the midrange and on any side of any element where additional bending yield may occur. I can do it. Duration lo must no longer pass and must be large
 - a) More lateral output of the element to the component where the yield occurs,
 - b) 1 / of the clean circumference of the element 6 and
 - c) 450 mm.
7. The spacing of the circles used as a first class save backing must not exceed 1/4 of the minimum element estimate. Moreover, you don't have to go through it, 75mm is bigger than 100mm.

3.8.5 Design Operation

STAAD. Pro contains a broad course of action of workplaces for arranging basic people as individual sections of a took apart plan. The part plan workplaces outfit the customer with the ability to pass on out a number of different arrangement exercises. These workplaces may design issue. The exercises to play out an arrangement are;

1. Decide the people and the stack cases to be considered in the arrangement.
2. Demonstrate whether to perform code checking or part assurance.
3. Decide plan limit regards, if not equivalent to the default regards.
4. Show whether to perform part decision by headway. These exercises may be repeated by the customer many occasions depending on the arrangement essentials. Seismic quake development oftentimes instigates power sufficiently huge to cause in elastic miss-happenings in the plan. In case the development is frail, sudden frustration could occur. However, in case the development is made to carry on malleable, it will really need to help the seismic quake impacts liked with some redirection greater over the yield evasion by maintenance of energy. As such pliability is further more required as a key segment for prosperity from sudden breakdown during outrageous dazes. STAAD. Pro has the capacities of performing strong arrangement as per IS 13920. While arranging it satisfies all plans of IS 456 – 2000 and IS 13920 for columns and sections.

3.8.6 Allowable Stress

STAAD's player layout and code testing. Pro are primarily based totally at the IS:800 allowable anxiety layout process (1984). It's a way for proportioning structural contributors below obligation situations with the aid of using the use of production masses and pressures, permissible stresses, and layout limits for the desired material. In this textbook, it is going to be not possible to cowl any a part of IS: 800. However, the main functions of the permissible stresses described with the aid of

using IS: 800 and carried out in STAAD will be mentioned on this section. Advantageous During the attention of different kinds of permissible pressures, suitable components of IS: 800 might be cited.

3.8.7 Multiple Analysis

Multiple studies in a single run can be wanted for structural analysis/format. To allow several analyses withinside the equal run, STAAD. Pro lets in the customer to modify input which incorporates member properties, help requirements, and so on in an input file. For format purposes, the effects of numerous analyses may be integrated. It may be possible to render those contributors disabled for one load case and then allow them for each different in systems with bracing. For this form of study, STAAD has an INACTIVE choice.

3.8.8 Post-Processing Facilities

The STAAD could use all of the output from the run for additional processing. The user interface is excellent.

3.8.9 Stability Requirements

The human beings' thinness proportions are expected and contrasted with the maximum noteworthy qualities. The commonly talking slenderness ratios for different classifications of human beings are summed up withinside the IS: 800. An appropriate maximal thinness percent for each element may be given withinside the STAAD execution of IS: 800. Pressure human beings might be checked closer to a maximum intense genuinely well sincerely properly really well worth of 180,

at the same time as pressure human beings might be checked closer to a awesome genuinely well sincerely properly really well worth of four hundred if no awesome thinness percent is determined.

3.8.10 Deflection Check

In this office, customers can include what they dislike as a model in their code review and parts backup efforts. Avoidance control can be controlled by three limits. Redirects are used, despite other strength and robustness-related principles. The Nahaversion rating is based on the latest rating results.

3.8.11 Code Checking

The purpose of the Code Check is to determine if a particular section meets the requirements of the relevant specification code. Code validation is based on IS: 800 Requirement (1984). Code-check equations use forces and moments on specific parts of a participant. You can specify the section using the BEAM parameter or the SECTION command. If the part is not listed, the code will be checked using power.

3.9 Design Steps in STAAD. Pro

Step 1: Develop a node center. With the plan in mind, I entered the average concentration in the STAAD log.

Step 2: Display the plate. I used the plate upload order to draw a plate that contains part of the hub focus in question.

Step 3: 3D view of the structure. Here it was shown that the momentary intermittent requirements of the Y bearing were used to obtain the 3D coefficients of the view of the structure.

Step 4: Descending support and assets. After creating the structure, the beams are determined to be fixed based on layout inspiration. In addition, the material was specified and the segment of the plate diagram was changed to variance.

Step 5: 3D conveyor view. You can name the asset to see the 3D promotion factors for improvement.

Step 6: Handle the wind mass. Wind Mass provides useful resources for using the words IS 875, Section 3, Energy and Transparency Factors. Until then, the nuances of the + X, X, + Z, Z mass-protected weight cases are natural.

Step 7: Appointment of a stupid mass.

Step 8: Weight Mixture Descent DL + LL, DL + LL + UPL, DL + LL + UPL + WL A worldwide diary of pure and applied science Exceptions 1,1,5 with 300 factors and accuracy Directional wind load + X, X, + Z, Z.

Step 9: Use STAAD's proven software program for the evaluation part and assign all required parameters. IS 456: 2000 and SP 16: 2000 are codebooks.

Step 10: Hold and run the record for printing the report. Check the number of errors that occurred in this process of the dam. If you get no results, you can change it to find out what went wrong. Final processing and evaluation printouts are removable.

Step 11: After the investigation, the simplest part of the total gravity dam is related to the start of STAAD. Foundation v8i is used to develop the entire house independently. Depending on your requirements, you can also record the basic form and tread depth.

CHAPTER – 4
DESIGN FOR CONCRETE DAM

4.1 Design of concrete gravity Dam sections

From a universal angle a gravity dam needs to fulfill the going with measures:

- 1.** It may be ensured in opposition to overturning at any even condition in the dam at the touch with the muse or in the foundation.
- 2.** It need to be secured in opposition to sliding at any stage aircraft in the dam, at the touch with the muse or alongside any topographical phase in the foundation.
- 3.** The element need to be evaluating a lot that the affordable weights in each the concrete and the muse need to now no longer exceed. Security of the dam shape is to be checked in opposition to probably loadings, which may be specified fundamental, discretionary or excellent.

The accumulating is made just like the fittingness and additionally for the overall which means of the store.

- 1.** Essential weights are perceived as all round fabric and of high significance of the heap.
- 2.** Discretionary weights are all round discretionary and of lesser diploma likes ediment hassle or heat tensions in view of mass organizing Astounding weights are organized depending on restricted standard fittingness or having low chance of event like inertial weights associated with seismic activity. Indeed a sturdy gravity dam receives its unity from the pressure of gravity of the substances withinside the component and hereafter the name. The gravity dam has enough load to resist the forces and the worrying 2nd performed through the water seized in the inventory in the back of it. Its movements the shops to the principles through cantilever movement and alongside those traces brilliant foundations are pre fundamental for the gravity dam. The forces that energize the dam include:

- 1.** Dam weight
- 2.** Underwater thrust

The forces that try to destabilize the dam include:

- 1.** Backwater stress

2. Uplift
3. Forces due waves withinside the reservoir
4. Ice stress
5. Temperature stresses
6. Silt stress
7. Seismic forces
8. The force against the wind load

Gravity dam is included in the formation as follows. Forces such as dam weight and water stress are calculated instantly from the unit load of fabric or house. Forces such as fluid loads, buoyancy, seismic loads, and subsidence stresses, ice stresses are best assumed based on various levels of reliability assumptions. Indeed, assessing the elegance of this power requires special attention and reliance on useful information, indulgence and judgment.

4.2 Calculations

Case 1: When the reservoir is empty.

Self-weight, $W = l \times b \times h \times \gamma_{con}$

$$W_1 = 04.6 \text{ m} \times 47 \text{ m} \times 100 \text{ m} \times 24 \times 9.81$$

$$= 509021.28 \text{ KN}$$

$$W_2 = \frac{1}{2} \times 30.4 \times 40 \times 2.4 \times 9.81 \times 100$$

$$= 1431475.2 \text{ KN}$$

Case 2: When the reservoir is at maximum level.

Self-weight $W_1 = 509022.28 \text{ KN}$

$$W_2 = 1431476.2 \text{ KN}$$

Water-pressure: $PW = \rho \times g \times h = 1000 \times 9.81 \times 40 \text{ mts.}$

$$PW = 392400 \text{ N/m}$$

$$= 392.4 \text{ KN/m}^2$$

$$\text{Water pressure} = \frac{1}{2} \times 40 \times 392.4$$

$$= 7848 \text{ KN}$$

Uplift pressure: $40/30 = 13.34 \text{ mts from base-}$

At heel $P' = \gamma h = 1000 \times 9.81 \times 40$

$$= 392400 \text{ N/m}$$

$$= 392.4 \text{ KN/m}$$

At toe $P = \gamma h$

$$= 1000 \times 9.8 \times 10$$

$$= 98100 \text{ N/m}$$

$$= 98.1 \text{ KN/m}$$

Snapshots of upsetting:- Moments of toppling:- Moments of toppling:- Moments of upsetting:-
Moments of toppling:- Moments of upsetting:- Moments of toppling:- Moments of upsetting:-
Moments of topple -

At this time $509021.28 \times 32.7 = 16644995$.

$$M_1 = W_1 \times 32.7$$

$$= 509021.28 \times 32.7$$

$$= 16644995.$$

$$M_1 = W_1 \times 32.7$$

$$= 509021.28 \times 32.7$$

$$= 16644995.86 \text{ KN-m}$$

$$M_1 = W_1 \times 32.7$$

$$= 509021.28 \times 32.7$$

$$= 16644995.86 \text{ KN-m is a unit of power.}$$

$$M_1 = W_1 \times 3M_1$$

$$= W_1 \times 3M_1$$

$$= W_1 \times 3 \times 29001687$$

$$= 1431475.2 \times 20.26 \text{ mts}$$

$$M_2 = W_2 \times 20.26 \text{ mts}$$

$$M_2 = M_1 + M_2$$

$$= 45646683.41 \text{ KN-m}$$

Opposing moments: $MW_1 = 784800 \times 13.34$

$$=10469232 \text{ KN-m}$$

$$M_{up1} = 490506 \times 20.26 \text{ m}$$

$$=9937530 \text{ KN-m}$$

$$MW_1 + M_{up1} = 10469231 + 9937531 \text{ KN-m}$$

$$\text{F.O.S} = 45646682/20406761$$

$$= 2.243 > 2$$

Safe Sliding: Friction $f_f = \mu \cdot N$

$$=0.6(509022.27 + 1432475.3)$$

$$= 1358347.536$$

$$W_p = 784801$$

$$\text{F.O.S.} = 1358348.537/784810$$

$$=1.72 > 1.5 \text{ Hence, Safe}$$

Case 3: When the reservoir is half fill

$$W_1 = 509011.28 \text{ KN}$$

$$W_2 = 1431465.2 \text{ KN}$$

Water pressure: $W_1 = \rho \times g \times h$

$$=1000 \times 9.81 \times 20 \text{ m}$$

$$=196200 \text{ N/m}$$

$$=196.2 \text{ KN/ m}^2$$

$$W_{p1} = \frac{1}{2} \times 20 \times 196.2$$

$$=1962 \text{ KN Acts on } 21/4 = 6.67 \text{ meters}$$

Uplift pressure:

$$\begin{aligned} \text{At heel } u_{p1} &= \gamma \times w \times h \\ &= 1000 \times 9.81 \times 20 \\ &= 196.2 \text{ KN/m} \end{aligned}$$

$$\begin{aligned} \text{At toe } U_{p2} &= \gamma \times w \times h \\ &= 1000 \times 9.81 \times 10 \\ &= 98100 \text{ N/m} \\ &= 98.1 \text{ KN/m} \end{aligned}$$

Over turning moment Stabilizing moment $M_{w1} = 16744996.86 \text{ KN-m}$

$$M_{W2} = 29001577.55 \text{ KN-m}$$

$$M_{W1} + M_{W2} = 45636683.51$$

$$\begin{aligned} \text{Opposing moment } M_{W1}' &= 196200 \times 6.67 \\ &= 108654 \text{ KN-m} \end{aligned}$$

$$M_{up}' = 257512.5 \times 2026 = 521621.26$$

$$M_{W1}' + M_{up}' = 6535847.35$$

$$\begin{aligned} \text{F.O.S.} &= 4554678.41 / 6535867.35 \\ &= 6.9972 \end{aligned}$$

$$\begin{aligned} \text{Safe Sliding force: Friction } F_f &= \mu n \\ &= 0.7 (509021.28 + 1431475.2) \\ &= 1358347.536 \text{ KN} \end{aligned}$$

$$W_p = 196200 \text{ KN}$$

$$\begin{aligned} \text{F.O.S.} &= 1258447.546 / 197300 \\ &= 6.8 > 1.5 \text{ Hence, Safe} \end{aligned}$$

4.3 Design in STAAD. Pro

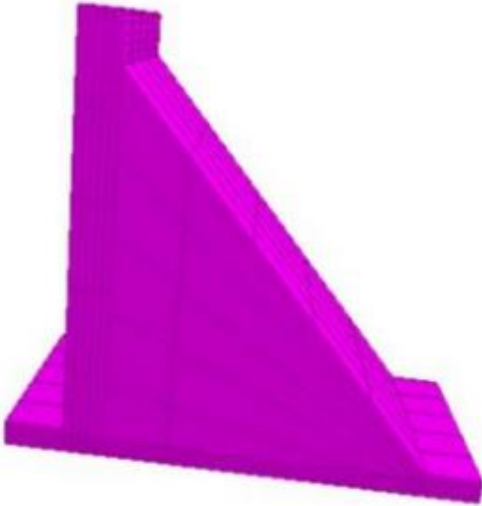

Fig. 3.1: 3-D Modeling in STAAD

Fig. 3.1 showing 3-D modelling in STAAD. Pro

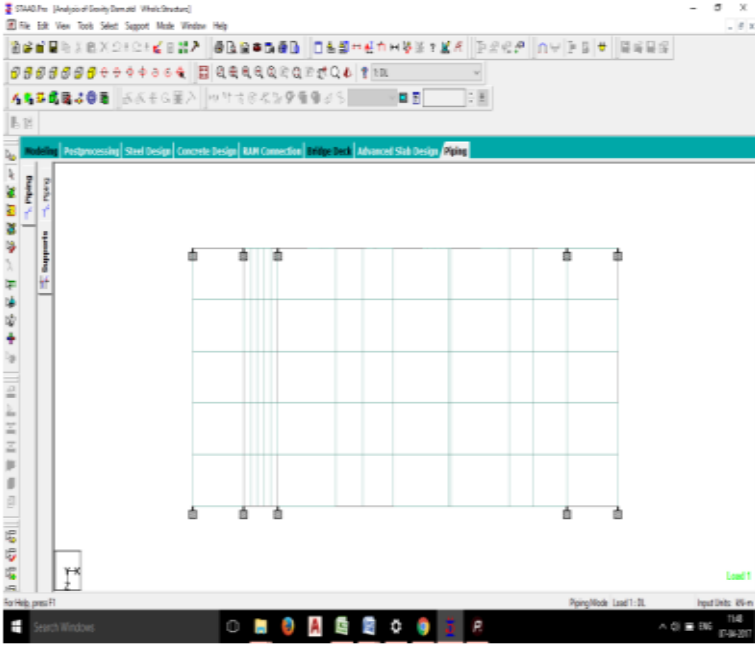

Fig. 3.2: Plan of the Dam

Fig. 3.2 showing the plan of the dam in STAAD. Pro

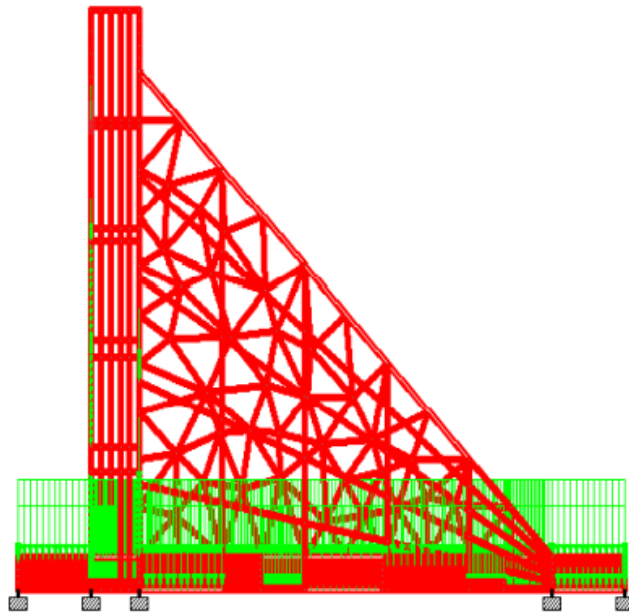

Fig. 3.7: Piping Assignments & Dead Load Conditions i.e. Self-Weight

Fig. 3.7 showing the piping assignments & dead load conditions i.e. self-weight in STAAD. Pr

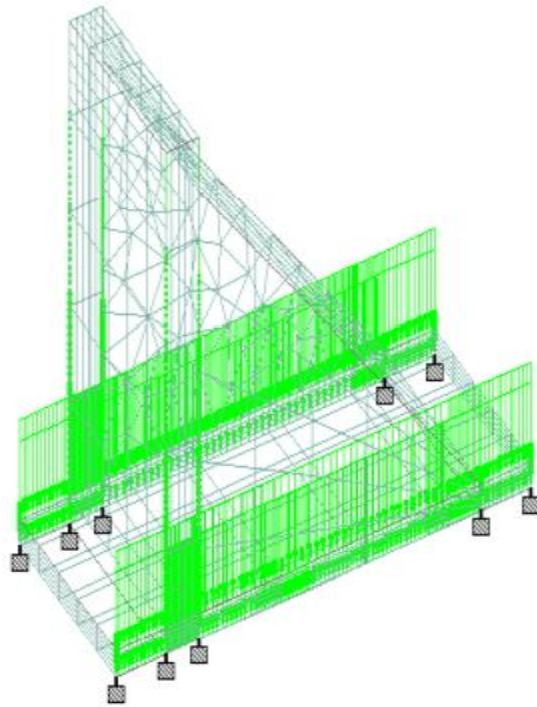

Fig. 3.8: Load Assignments IS Codes

Fig. 3.8 showing the load assignments according to IS Codes in STAAD. Pro

Number of Nodes	442 Highest Node
442	
Number of Elements	256 Highest Beam
664	
Number of Plates	434 Highest Plate
702	
No. of Basic Load Case	1
No. of Combination Load Case	3

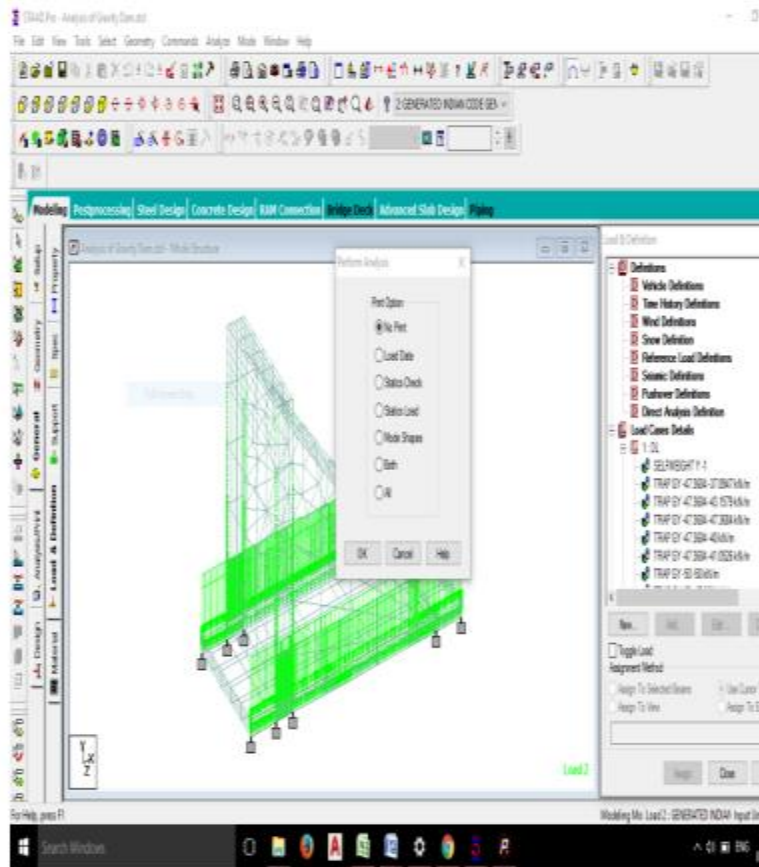

Fig. 3.9: Analysis Input Data Assignments

Fig. 3.9 showing the analysis of input data assignments in STAAD. Pro

Table 4.1 – Analysis of Gravity Dam

Node	X (m)	Y (m)	Z (m)
1	0	0	0
2	0	90	0
3	10	0	0
4	10	90	0
5	95	0	0
6	10	80	0
7	0	0	50
8	0	90	50
9	10	0	50
10	10	90	50
11	95	0	50
Beam	Node A	Node B	Property
1	1	34	3
2	3	434	3
3	6	404	3
4	1	318	3
5	2	298	3
6	1	36	3
7	2	29	3
8	3	151	3
9	4	250	3

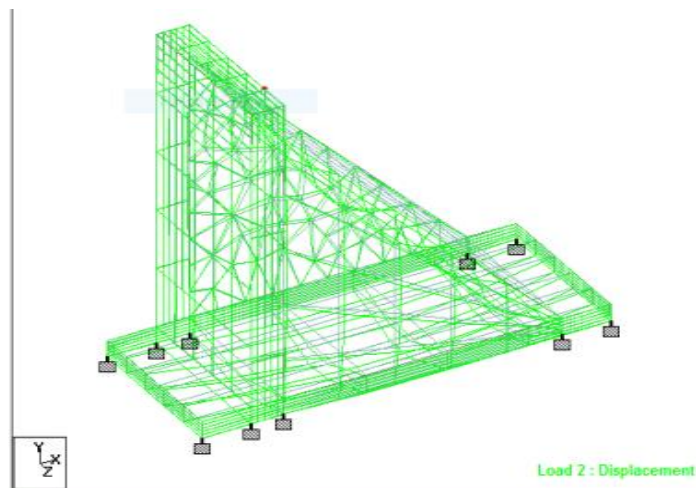

Fig. 3.10: Displacement

Fig. 3.10 showing the displacement phenomena of the dam in STAAD. Pro

Table 4.2 – Displacement Values

Node	L/C	Horizontal		Vertical	Resultant	Rotational		
		X (mm)	Y (mm)	Z (mm)		(mm)	rX (rad)	rY (rad)
1	1 DL	1.306	-19.291	-32.795	38.07	0	-0.004	0
	2 Generate	1.959	-28.936	-49.193	57.106	0.001	-0.006	0
	3 Generate	1.567	-23.149	-39.394	45.685	0	-0.005	0
	4 Generate	1.175	-17.362	-29.516	34.263	0	-0.003	0
2	1 DL	42.77	-27.771	-52.793	73.4	0	0	0
	2 Generate	64.155	-41.656	-79.19	110.101	0	0	0
	3 Generate	51.324	-33.325	-63.352	88.081	0	0	0
	4 Generate	38.493	-24.994	-47.514	66.06	0	0	0
Beam	L/C	Dist. (m)	X (mm)	Y (mm)	Z (mm)	Resultant (mm)		
1	1DL	0	0	0	0	0		
		4.5	-0.049	0	1.327	1.328		
		9	-1.044	0	1.659	1.961		
		13.5	-1.518	-0.001	1.162	1.912		
		18	0	0	0	0		
	2 Generate	0	0	0	0	0		
		4.5	-0.073	0	1.99	1.992		
		9	-1.566	0	2.489	2.941		
		13.5	-2.277	-0.001	1.743	2.867		
		18	0	0	0	0		

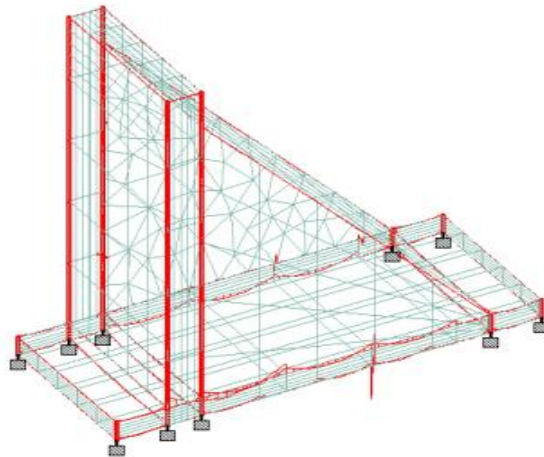

Fig. 3.11: Bending

Fig. 3.11 showing the bending phenomena of the dam in STAAD. Pro

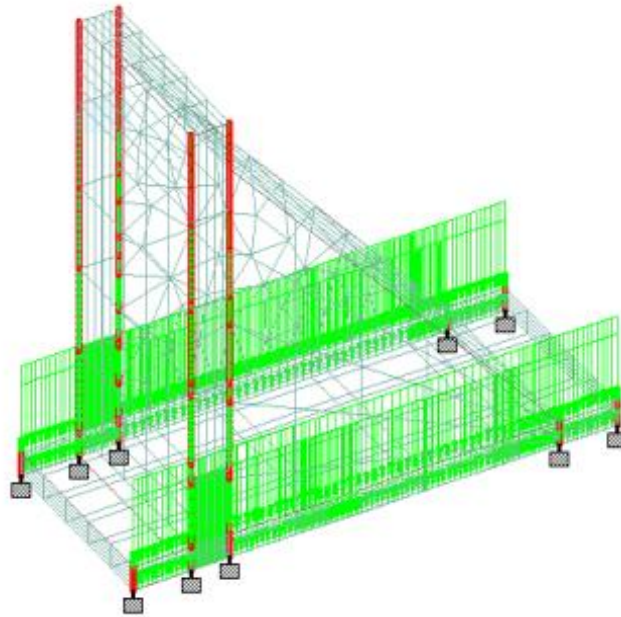

Fig. 3.12: Displacement along axis

Fig. 3.12 showing the displacement of the dam along axis

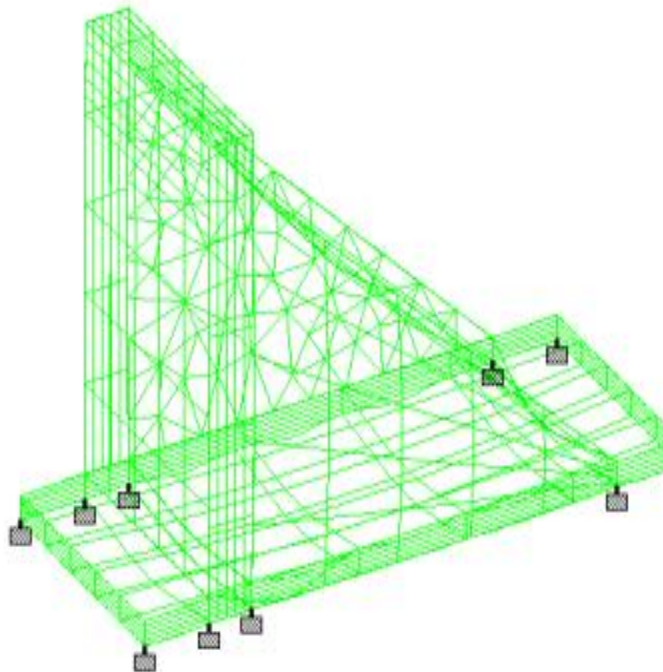

Fig. 3.13: Displacement Conditions for Load Assignment

Fig. 3.13 showing the displacement conditions for load assignments

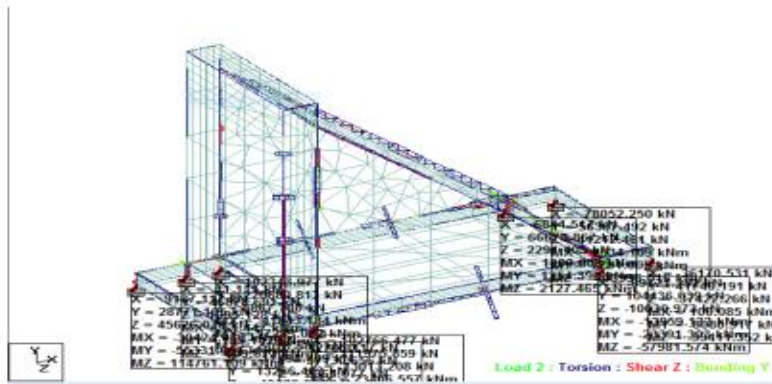

Fig. 3.14: Torsion, Shear along Z, Bending along Y

Fig. 3.14 showing the torsion and shear along Z and bending along Y

Table 4.3 – Moment Values

Node	L/C	Fx (KN)	Fy (KN)	Fz (KN)	Mx (KNm)	My (KNm)	Mz (KNm)
17	1DL	-27.407	31252.461	730.085	40.964	130.094	-539.914
	2 GENERATE	-41.111	46878.691	1095.128	61.447	195.142	-809.872
	3 GENERATE	-32.889	37502.957	876.102	49.157	156.113	-647.897
	4 GENERATE	-24.667	28127.213	657.077	36.868	117.085	-485.923
18	1 DL	68229.32	147.12055E	5911.805	-27895.455	38188.719	-3385.726
	2 GENERATE	102.34398E	220.68081E	8867.708	-41843.184	57283.062	-5078.588
	3 GENERATE	81875.188	176.54467E	7094.167	-33474.547	45826.469	-4062.871
	4 GENERATE	61406.387	132.40848E	5320.624	-25105.908	34369.848	-3047.153
19	1 DL	-4563.011	44452.578	1527.603	666.669	836.264	1418.31
L/C		Fx (KN)	Fy (KN)	Fz (KN)	Mx (KNm)	My (KNm)	Mz (KNm)
1	Loads	0	-565.29742	0	1.43E+01	0.002	-20.4857
	Reactions	-0.008	565.29742	0.005	-1.43E+01	-0.248	20.4857
	Difference	-0.008	-0.002	0.005	-0.098	-0.247	-0.096

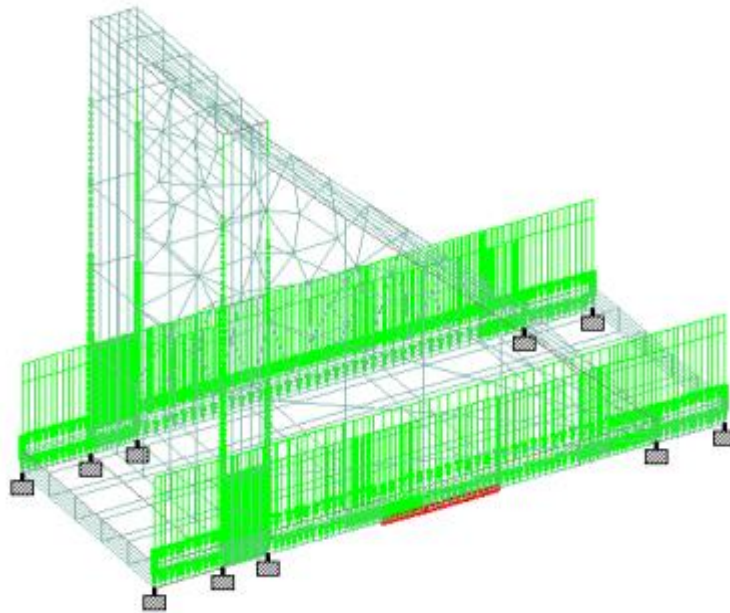

Fig. 3.15: Postprocessing

Fig. 3.15 showing the postprocessing mode in STAAD. Pro

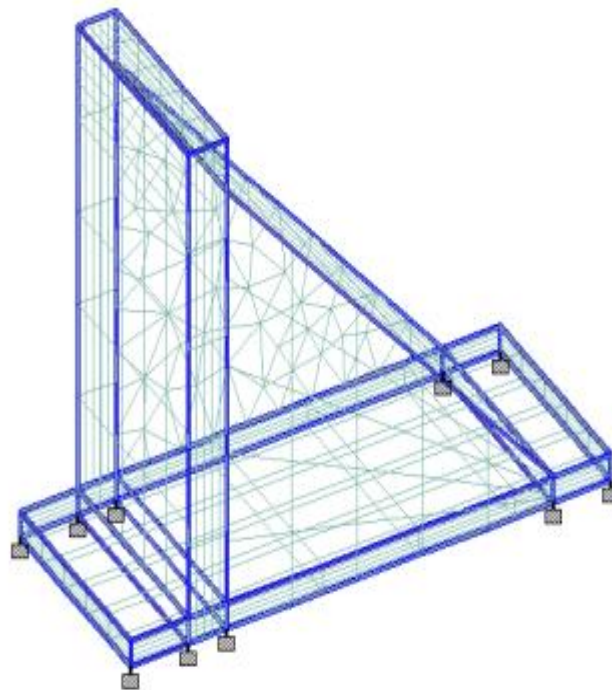

Fig. 3.16: Membrane & Bending

Fig. 3.16 showing the membrane and bending of the da in STAAD. Pro

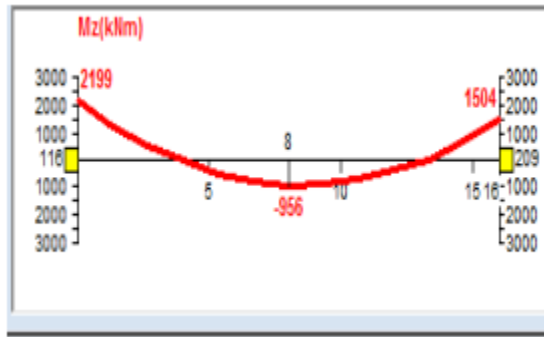

Fig. 3.17: Moment along Z

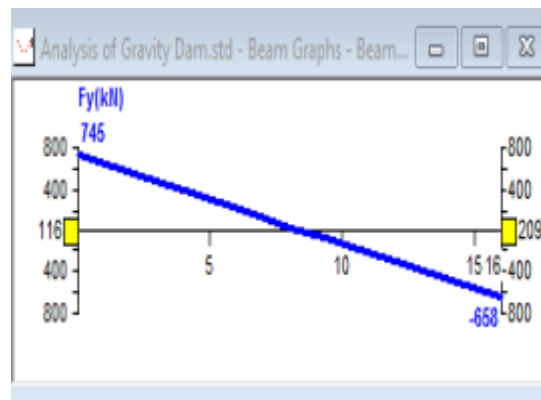

Fig. 3.18: Shear force along Y-direction

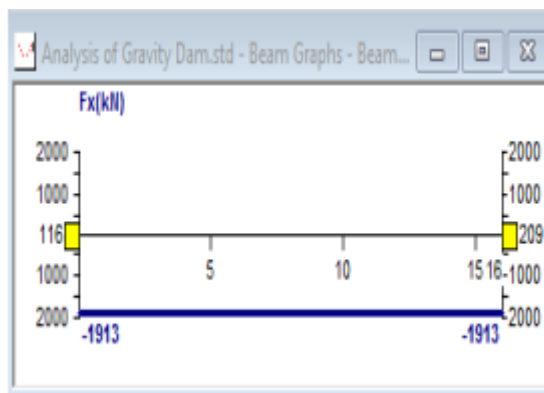

Fig. 3.19: Shear force along X-direction

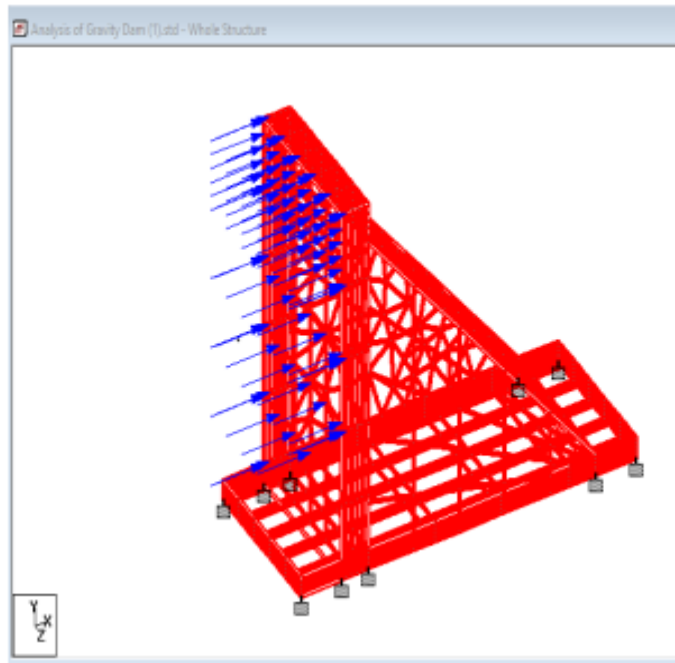

Fig. 3.20: Wind direction x with 15 KN-m

Fig. 3.20 showing the direction of wing along X-direction

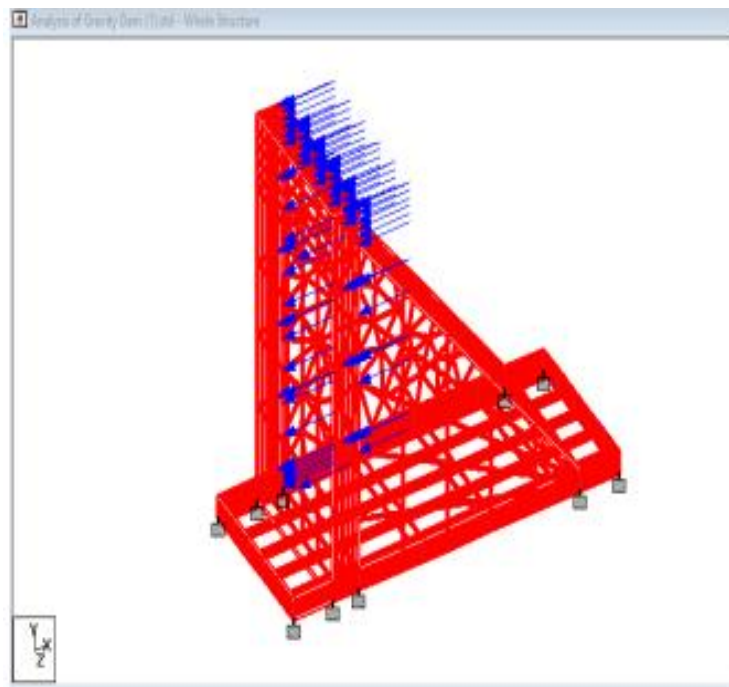

Fig. 3.21: Wind direction -x with 15KN-m

Fig. 3.21 showing the direction of wind along -X direction

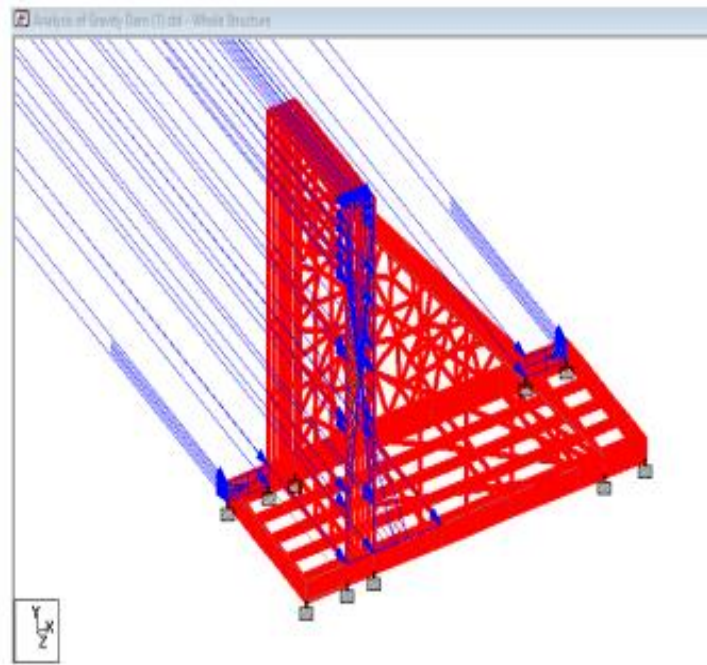

Fig. 3.22: Wind direction z with 15KN-m

Fig. 3.22 showing the direction of wind along Z direction

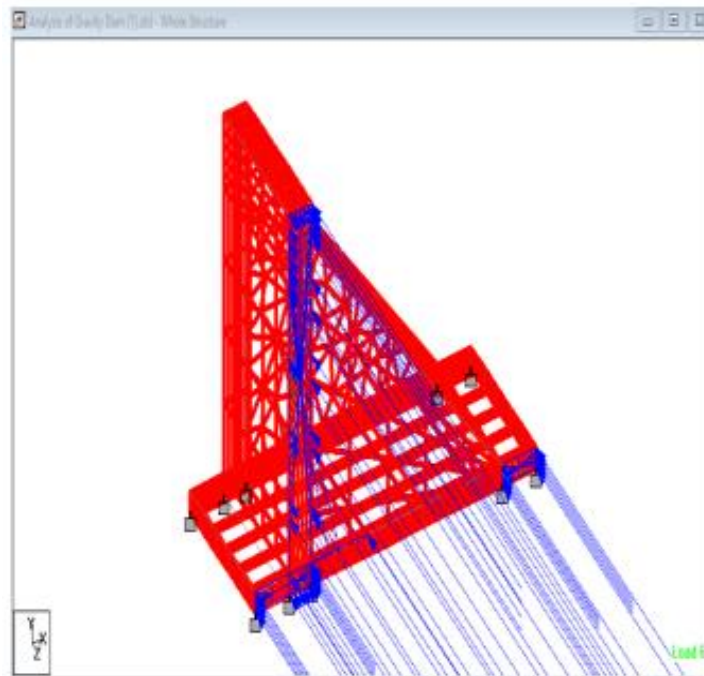

Fig. 3.23: Wind direction -z with 15KN-m

Fig. 3.23 showing the direction of wind along -Z direction

Table 4.4 – Node Displacement

Node	L/C	Horizontal		Vertical	Resultant	Rotational		
		X (mm)	Y (mm)	Z (mm)		(mm)	rX (rad)	rY (rad)
1	1 DL	1.306	-19.291	-32.795	38.07	0	-0.004	0
	2 WL+X	0.002	0.014	0.074	0.076	0	0	0
	3 WL-X	-0.002	-0.014	-0.031	0.034	0	0	0
	4 WL+Z	-0.031	-0.089	11.12	11.12	0	0.001	0
	5 LL	-0.424	-1.984	-33.843	33.903	0	-0.015	0
	6 WL-Z	0.031	0.091	-11.249	11.249	0	-0.001	0
	7 Generate	1.322	-31.913	-99.957	104.936	0	-0.028	0
	8 Generate	1.06	-25.514	-79.876	83.858	0	-0.022	0
Beam	L/C	Dist. (m)	X (mm)	Y (mm)	Z (mm)	Resultant (mm)		
1	1DL	0	0	0	0	0		
		4.5	-0.049	0	1.327	1.328		
		9	-1.044	0	1.659	1.961		
		13.5	-1.518	-0.001	1.162	1.912		
		18	0	0	0	0		
	2 WL+X	0	0	0	0	0		
		4.5	0.002	0	0	0.002		
		9	0	0.001	0	0.001		
		13.5	-0.002	0	-0.001	0.002		
		18	0	0	0	0		

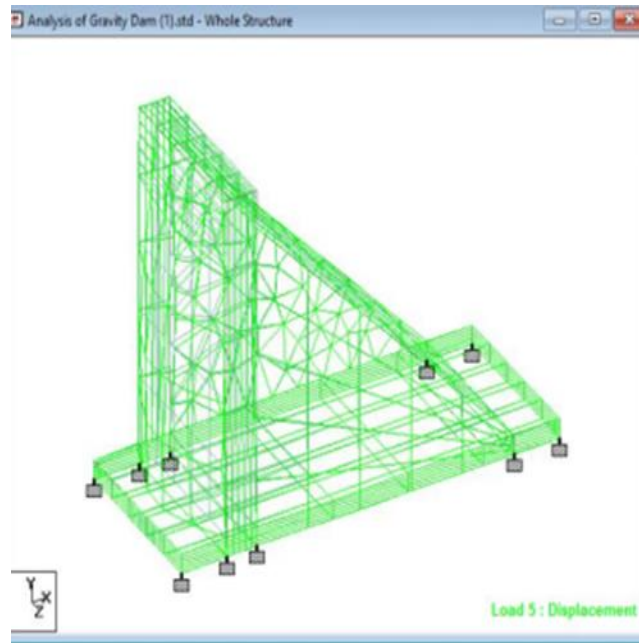

Fig. 3.24: Live Load Analysis

CHAPTER – 5
RESULTS AND DISCUSSIONS

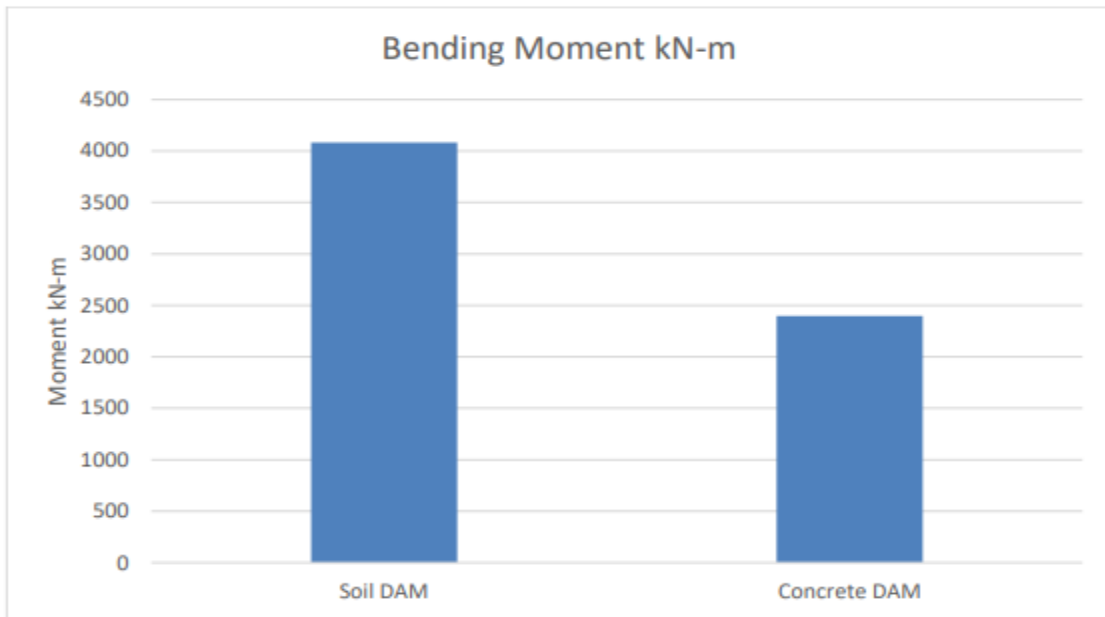

Fig. 5.1 Bending Moment

Fig. 5.1 showing the bending moment where bending moment of soil dam is higher than the bending moment of concrete dam

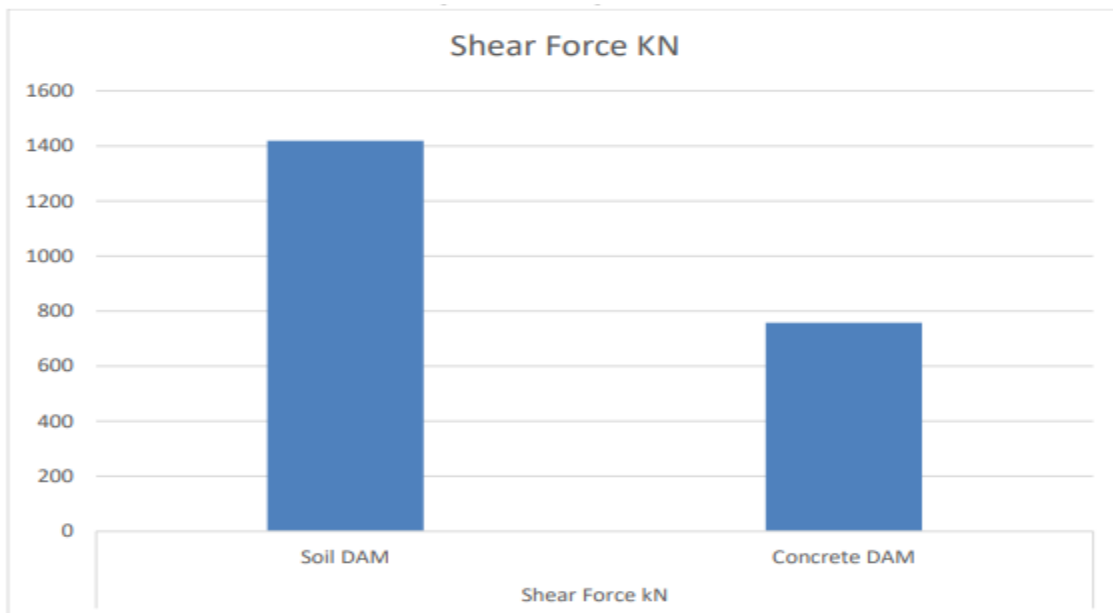

Fig. 5.2 Shear Force

Fig. 5.2 showing the shear force where shear force of soil dam is higher than the shear force of concrete dam

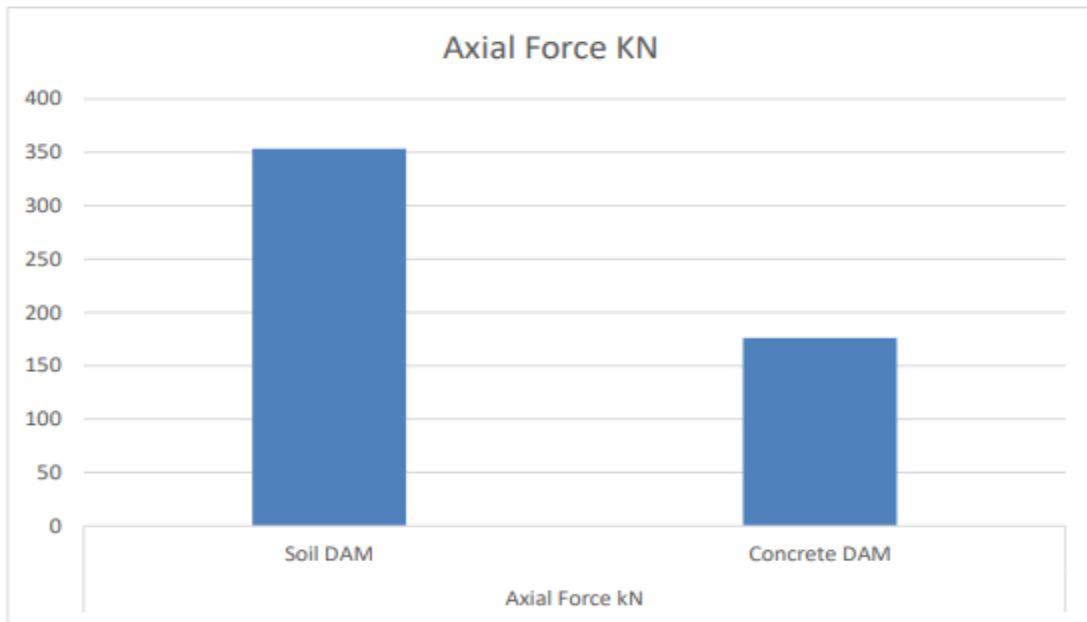

Fig. 5.3 Axial Force

Fig 5.3 showing the axial force where axial force of soil da is higher than the axial force of concrete dam

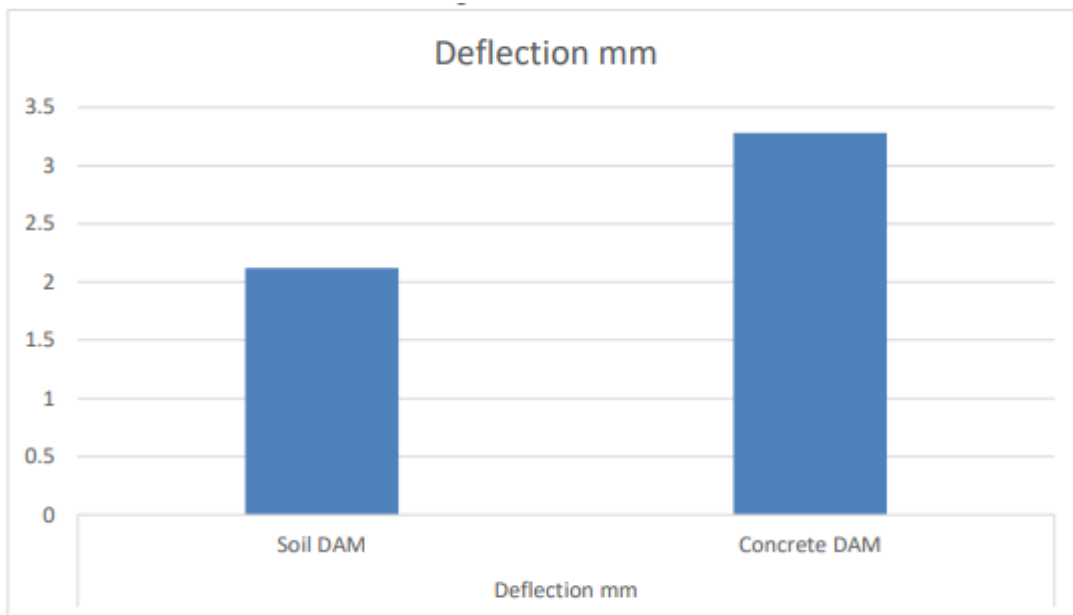

Fig. 5.4 Deflection

Fig. 5.4 showing the deflection where deflection of concrete dam is more than deflection of soil dam

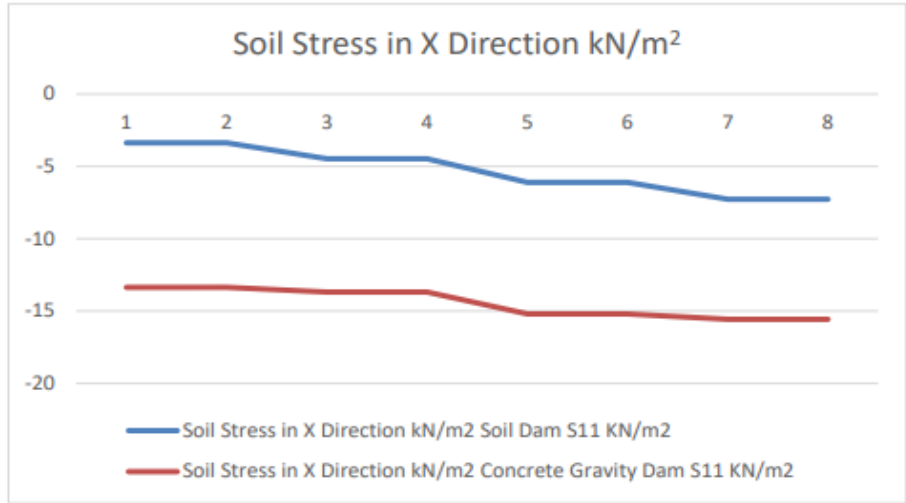

Fig. 5.5 Soil Stress in X-Direction

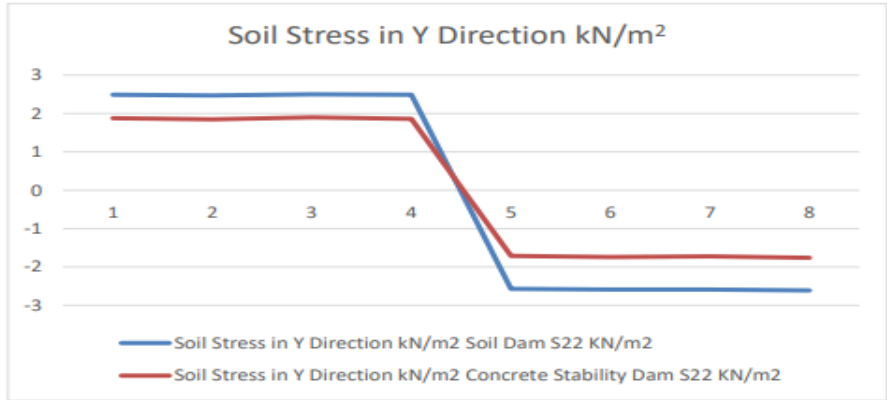

Fig. 5.6 Soil Stress in Y- Direction

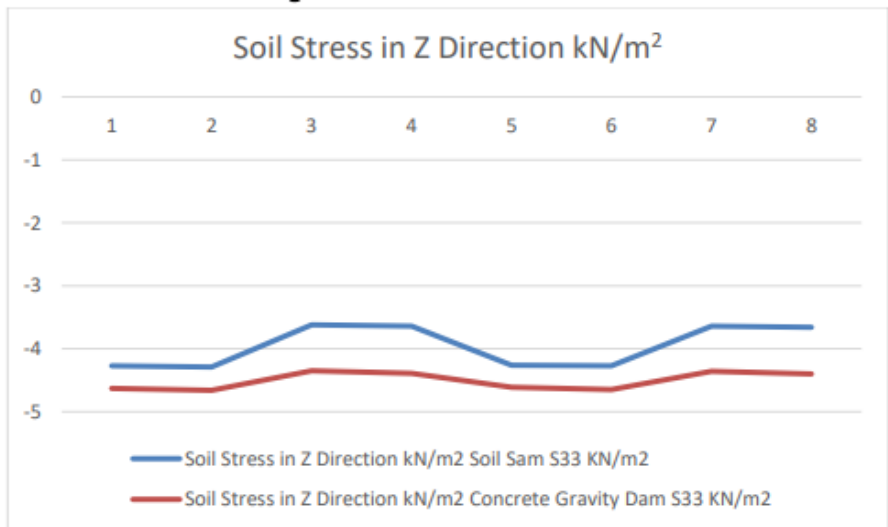

Fig. 5.7 Soil Stress in Z - Direction

Tables and Results

Table 5.1 - Results

S.No.	Force	Horizontal Force	Vertical Force
1	Self-Weight		509021.28
	M1		1431475.2
	M2		
2	Water Pressure, W	748400	
3	Uplift Pressure, at heel		-396.2
	At toe		-98.1
4	Silt Pressure	-180	
S.No.	Force	Horizontal Force	Vertical Force
1	Self-Weight		509021.28
	M1		
	M2		1431475.2
2	Water Pressure, W	196200	
3	Uplift Pressure		
	At heel		-196.2
	At toe		-98.1
4	Silt Pressure	-180	

CHAPTER – 6
CONCLUSION

The dam has been analyzed with CODE IS:6512-1984, the variable deflection discovered very much less about 0.002 mts which may be taken into consideration as negligible. After, acting the evaluation the errors discovered to be 0 which means the layout of the shape is huge and the widespread hundreds are taken for evaluation of stay and wind hundreds. STAAD –seasoned given consequences ought to be optimized almost to implement shape finalization in future. From, the modeling and evaluation the consequences may be concluded as consistent with the following points:

- 1). The maximum elongation of a dam with an opening is $4193,257 \text{ KN} / \text{m}^2$, and the maximum elongation of a dam without an opening is $3117,744 \text{ KN} / \text{m}^2$.
- 2). For non-open dams, most stresses are concentrated near the u / s surface gradient of $0.59 \text{ N} / \text{mm}^2$ to $0.977 \text{ N} / \text{mm}^2$.
- 3). Dams with openings, the maximum stress concentrated in the openings is $4.13 \text{ N} / \text{mm}^2$.
- 4). Therefore, the long-distance static load due to seismic force is consistent with STAAD. According to the definition and command, it is not currently manual, but this white paper does not consider dynamic evaluation.
- 5). There are still some uncertainties surrounding the balance in support terms.

Shear Force

Shear stress is called the unbalance stress placed due to interaction of hydrostatic pressure at wall continuously, in our observe it is placed that with concrete dam it may be minimized in all the times considered for observe.

Axial Force

Axial stress is called normal stress. Please refer to the following. This stress is intended to distribute the load from the mold to the earth. In the case of dam walls, it has been pointed out that the distribution of vertical force can be processed without problems.

Bending Moment

For deflection $2d$, it is assumed that the minimum deflection is in the dam. This leads to a very favorable cost in the evaluation, as the deflection $2d$ is now proportional to the reinforcement requirements.

Deflection

In case of deflection we placed that maximum deflection is obtained in Soil dam in assessment to concrete dam due to stability of concrete mass.

Base Analysis

Proof of stability of gravity dams is initially done without seismic force. Therefore, the assessment is that the sum of horizontal and normal forces can cause the dam in the presence of various loads such as dead load, water / hydrostatic pressure, buoyancy, + $ve2d$ and general cumulative values of $ve2d$. It emphasizes that there are many stable. It is also easy to evaluate that $2d$ due to its own weight acts as a resistant $2d$ to $2d$ generated by water or buoyancy. + Which technique completes the stability in the fall direction when $ve 2d$ exceeds 5 moments? Sliding stability is based on the coefficient of friction, but is the sum of all vertical and all horizontal forces.

REFERENCES

[1] **Fig.1.1** <https://upload.wikimedia.org/wikipedia/commons/6/6a/Willowcr.jpg>

[2] Anveshna's International Journal of Research and engineering in applied sciences Anvshana's Email-ID anveshanaindia@gmail.com Website- www.anveshanaindia.com Design and analysis of gravity dam –A case study analysis using staad.pro.

[3] Karuna Moy Ghosh, Analysis and Design Practice of Hydraulic Concrete Structure PHI Learning Private Limited.

[4] US Army Corps of Engineers "Gravity Dam Design "EM1110-2-220030 June 1995

[5] Bentley, "STAAD. Pro www.bentley.com./enUS/Products/STAAD.Pro

[6] "Practice for Galleries and different Openings in Dam, Bureau of India Standards, New Delhi.

[7] IS12966 (Part2) -1990, "Practice for Galleries and different openings in Dam, Bureau of Indian Standards, New Delhi.

[8] IS6512 - 1984, "Criteria for style of Solid Gravity Dam Bureau of Indian Standards, New Delhi.

[9] "Stability Analysis of Concrete Gravity Dam for Seismic Loading in Afghanistan" through manner of way of Mohammad Ejaz Shahir, Priyanka Dhurvey in June 2017

[10] Stability Analysis of Gravity Dam through manner of way of Using STAAD Pro in Time History Method" through manner of way of S.Sree Sai Swetha in March 2017

[11] "Seismic & Stability Analysis of Gravity Dam" through manner of way of Miss. Meghna S. Bhalodkar in 2014.

[12] IS65121984 Criteria for style of Solid Gravity Dam Bureau of Indian Standards New Delhi

[13] "Seismic And Stability Analysis of Gravity Dams Using STAAD.Pro" by T Subramani, D.Ponnuvel in June 2012

[14] "Stability Analysis of Concrete Gravity Dam for Seismic Loading in Afghanistan" by Mohammad Ejaz Shahir Priyanka Dhurvey in June 2017.

[15] Stability Analysis of Gravity Dam by Using STAAD. Pro in Time History Method by S.Sree Sai Sweth in March 2017

- [16] “Seismic & Stability Analysis of Gravity Dam” by Miss Meghna S Bhalodkar in 2014
- [17] “Analysis of Concrete Gravity Dam by 3D Solid Element Modeling Using STAAD Pro” By Jay Patel R. Chhaya in May 2015
- [18] “Design and Analysis of Gravity Dam –A Case Study Analysis Using STAAD. Pro” By mettu Rajesh Reddy, M Nageswara rao in 2017
- [19] “Finite Element Analysis of Concrete Gravity Dam by Using STAAD. PRO” by Rampure Aarti Baburao Mangulkar Madhuri in 2016.
- [20] Structural Stability and 2D Finite Element Analysis of Concrete Gravity Dam by Khalid Dawlatzai, Dr. Manju Dominic
- [21] Stability analysis of Concrete gravity Dam on complicated foundation with multiple slide planes by Ren Xuhua, Shu Jiaqing, Ben Nenghui. Ren Hongyun in 2008.
- [22] Seismic cracking analysis of concrete. gravity dams with. initial cracks Using the extended finite element method by .Sherong Zhang Gaohui Wang Xiangrong Yu in 2013.
- [23] “Comparison of Design and Analysis of Concrete Gravity Dam” by Md Hazrat Ali, Md Rabiul Alam in 2011
- [24] Shake table sliding response of a gravity dam model including water, uplift pressure by Mathieu Rochon Cyr Pierre Léger in 2009
- [25] Shake table sliding response of a gravity dam model including water uplift pressure. By Mathieu Rochon Cyr Pierre .Léger in 2013.
- [26] Seismic. fracture analysis of Concrete gravity dams including dam reservoir interaction by Yusuf Calayir. Muhammet karaton. in 2005.
- [27] Seismic structural stability of concrete gravity dams considering transient. uplift. Pressures in cracks by Farrokh Javanmardi Pierre Léger, René. Tinawi in 2004
- [28] Dasgupta G and Chopra AK (1979) Dynamic Stiffness Matrices for Homogeneous Viscoelastic. Half Plane ASCE J of Eng. Mechanics Vol 105, pp 72.9-7.45.

[29] Chopra A.K and Chakrabarti P (1981) Earthquake Analysis of Concrete Gravity Dams including Dam Water Foundation Rock Interaction Earth Eng & Struc Dynamics, Vol. .9 pp 363-383.

[30] Zienkiewicz C and Taylor RL (1991) The finite element method volume I.I Forth. edition, First published In I967 by Mc.Graw-Hill. .p.p 4.0.7-4.19.

JAYPEE UNIVERSITY OF INFORMATION TECHNOLOGY, WAKNAGHAT

PLAGIARISM VERIFICATION REPORT

Date:

Type of Document (Tick): PhD Thesis M.Tech Dissertation/ Report B.Tech Project Report Paper

Name: _____ Department: _____ Enrolment No _____

Contact No. _____ E-mail. _____

Name of the Supervisor: _____

Title of the Thesis/Dissertation/Project Report/Paper (In Capital letters): _____

UNDERTAKING

I undertake that I am aware of the plagiarism related norms/ regulations, if I found guilty of any plagiarism and copyright violations in the above thesis/report even after award of degree, the University reserves the rights to withdraw/ revoke my degree/report. Kindly allow me to avail Plagiarism verification report for the document mentioned above.

Complete Thesis/Report Pages Detail:

- Total No. of Pages =
- Total No. of Preliminary pages =
- Total No. of pages accommodate bibliography/references =

(Signature of Student)

FOR DEPARTMENT USE

We have checked the thesis/report as per norms and found **Similarity Index** at(%). Therefore, we are forwarding the complete thesis/report for final plagiarism check. The plagiarism verification report may be handed over to the candidate.

(Signature of Guide/Supervisor)

Signature of HOD

FOR LRC USE

The above document was scanned for plagiarism check. The outcome of the same is reported below:

Copy Received on	Excluded	Similarity Index (%)	Generated Plagiarism Report Details (Title, Abstract & Chapters)	
	<ul style="list-style-type: none">• All Preliminary Pages• Bibliography/Images/Quotes• 14 Words String		Word Counts	
Report Generated on		Submission ID	Character Counts	
			Total Pages Scanned	
			File Size	

Checked by
Name & Signature

Librarian

.....

Please send your complete thesis/report in (PDF) with Title Page, Abstract and Chapters in (Word File) through the supervisor at plagcheck.juit@gmail.com