

# **DATA AGGREGATION AND PERFORMANCE IMPROVEMENT IN WIRELESS SENSOR NETWORKS**

*Thesis submitted in fulfillment of the requirements for the Degree of*

**DOCTOR OF PHILOSOPHY**

By

**HRADESH KUMAR**  
**Enroll No 166203**



Department of Computer Science and Engineering

JAYPEE UNIVERSITY OF INFORMATION TECHNOLOGY  
Waknaght, Solan -173234, Himachal Pradesh  
INDIA

December, 2019

# TABLE OF CONTENTS

CONTENT	Page No.
SUPERVISOR CERTIFICATE	i
ACKNOWLEDGEMENT	ii
ABSTRACT	iii
LIST OF FIGURES	iv-vi
LIST OF TABLES	vii
LIST OF ACRONYMS	viii
CHAPTER 1 INTRODUCTION	1-7
1.1 Introduction	1
1.2 Problem Statement	2
1.3 Motivation	2
1.4 Objectives	3
1.5 Contributions	3
1.6 Chapter's Layout	5
CHAPTER 2 REVIEW OF LITERATURE	8-28
2.1 Introduction	8
2.2 Data Aggregation in WSN	8
2.3 Data Aggregation techniques	13
2.3.1 Tree Based Data Aggregation	13
2.3.2 Cluster Based Data Aggregation	14
2.3.3 Chain Based Data Aggregation	15
2.3.4 Grid Based Data Aggregation	15
2.4 Performance Improvement in WSN	16
CHAPTER 3 DATA AGGREGATION IN WSN	29-41
3.1 Introduction	29
3.2 Data Aggregation Techniques	30
3.3 Proposed Model	33
3.3.1 Proposed Algorithm PLBDA	34
3.3.2 Simulation Scenario	34

3.3.3 Analysis on Results	35
3.4 Summary	41
CHAPTER 4 NETWORK THROUGHPUT AND LIFETIME OF NETWORK IN WSN	42-52
4.1 Introduction	42
4.2 Proposed Model	43
4.2.1 Simulation Scenario	46
4.3 Analysis on Results	47
4.4 Summary	52
CHAPTER 5 ENERGY CONSUMPTION IN WSN	53-62
5.1 Introduction	53
5.2 Proposed Model	54
5.2.1 Energy Consumption	55
5.2.2 Proposed Algorithm	57
5.3 Experimental Results	57
5.3.1 Simulation Scenario	57
5.3.2 Analysis on Results	58
5.4 Summary	62
CHAPTER 6 HETEROGENITY IN WIRELESS SENSOR NETWORKS	63-78
6.1 Introduction	63
6.2 Proposed Model	64
6.2.1 CH SELECTION	66
6.2.2 Flow Chart of Proposed Model	68
6.2.3 Simulation Setup	69
6.2.4 Performance Parameters	70
6.3 Analysis on Results	70
6.4 Summary	78
CHAPTER 7 FUZZY LOGIC IN WSN	79
7.1 Introduction	79
7.2 Proposed Model	80
7.2.1 Fuzzy Rule for Throughput	83
7.2.2 Fuzzy Rule for First Node Dead	87

7.3 Experimental Results and Simulation Setup	88
7.3.1 Simulation Scenario	88
7.3.2 Analysis on Results	89
7.4 Summary	93
CHAPTER 8 CONCLUSION AND FUTURE SCOPE	94-95
8.1 Conclusion	94
8.2 Future Scope	95
REFERENCES	96-104
LIST OF PUBLICATIONS	105

## **SUPERVISOR CERTIFICATE**

This is to certify that the work reported in the Ph.D. thesis entitled “**Data Aggregation and Performance Improvement in Wireless Sensor Networks**”, submitted by **Hradesh Kumar (Enroll No. 166203)** at **Jaypee University of Information Technology, Wagnaghat, Solan, India**, is a bonafide record of his original work carried out under my supervision. This work has not been submitted elsewhere for any other degree or diploma with best of my knowledge and belief.

Dr. Pradeep Kumar Singh

Associate Professor

Department of Computer Science and Engineering

Jaypee University of Information Technology

Wagnaghat, Solan, India

173234

## **DECLARATION BY THE SCHOLAR**

I hereby declare that the work reported in the Ph.D. thesis entitled “**Data Aggregation and Performance Improvement in Wireless Sensor Networks**” submitted at **Jaypee University of Information Technology, Wagnaghat, Solan, India** is an authentic record of my work carried out under the supervision of **Dr. Pradeep Kumar Singh**. I have not submitted this work elsewhere for any other degree or diploma. I am fully responsible for the contents of my Ph.D Thesis.

Hradesh Kumar

Department of Computer Science and Engineering

Jaypee University of Information Technology

Wagnaghat, Solan, India

173234

## ACKNOWLEDGEMENT

Indeed the words at my command are not adequate, either in form of spirit or express the depth of my humility and kindness before Almighty one without whose endless benevolence and blessings this tedious task could not have been accomplished. I express my sincere gratitude to Vice-Chancellor Prof. (Dr.) Vinod Kumar, Director and Academic Head Prof. (Dr.) Samir Dev Gupta for kind support and successful completion of this research work. I place on record unbounded gratitude to my teachers and supervisor, Dr. Pradeep Kumar Singh, Associate Professor, Department of Computer Science Engineering and Information Technology, Jaypee University of Information Technology, Waknaghat, Solan (HP), India for showing me the real path of sincerity and dedication. In them I found that the best are not only efficient, effective and result driven, but at “core they are persons with the best qualities as human beings”. Humanity, scientific potentials, kindness, coolness, simplicity, novelty of ideas are the arms of their great personality. I am grateful and indebted to Dr. Pradeep Kumar Singh for allowing me to work under his supervision, and for his invaluable painstaking efforts taken towards my study. I owe my thanks to Prof. (Dr.) S. P. Ghrera, Brig. (Retd.) Head Department of Computer Science & Engineering and Information Technology. I sincerely thanks to Dr. Vivek Sehgal, Dr. Ekta Gandotra, Dr. Harsh Sohal, and other faculty members for providing me feedback, moral support, valuable suggestions and necessary facilities during the course of my research work. I also like to thank Mr. Amit Kumar Shrivastva and Lab Technicians of all computer labs in JUIT, for their help and cooperation. I would say thanks for my dear friends Nagesh Kumar, Vandana Mohindru, Dinesh Kumar, Amit Sharma, Namita Agarwal and Nidhi Sharma for continuous support and encouragement during my research work. It will never be possible for me to pay for the price of sacrifices, which my parents have made for my success. The hardships to which they came across during my study, the afflictions with which they have suffered, the tears which they shed for me and painful situations which they have crossed for my ultimate settlement. These are the devote prayers of my mother Mrs. Vasamati and dreams of my father Mr. Rajendra Singh.

Hradesh Kumar

## ABSTRACT

Wireless sensor networks are widely used in the modern era. Wireless sensor networks are used in many applications like forest fire detection, healthcare system, agriculture, smart home, military and many more. Wireless sensor networks are a combination of sensor nodes. These nodes have their own capabilities like transmission the data, reception the data and processing the data. Each node has a battery generally which is not rechargeable. Hence energy consumption is one of the important issues in WSN. Energy consumption directly affects on the network's lifetime. There are many techniques to reduce energy consumption in the literature. Data aggregation is one of the most suitable techniques to reduce the energy consumption in the network. Data aggregation aggregates the data from the network then forwarded to the sink node. There is a data aggregator node in data aggregation technique. The whole responsibility of data aggregation is a data aggregator node's. There are mainly four types of data aggregation techniques: tree-based data aggregation, cluster-based data aggregation, chain-based data aggregation, and grid-based data aggregation. Each technique has its own advantages and disadvantages. Data aggregation and performance improvement of the network have mainly considered in this thesis.

There are number of performance parameters in wireless sensor networks like network lifetime, throughput of the network, end to end delay, latency, power consumption, goodput of the network, packet delivery ratio, energy consumption, etc. out of these performance parameters network lifetime, throughput of the network, energy consumption, and power consumption have considered in this thesis.

The prime motivation of the work is to improve the lifetime of the network, enhance the network throughput, reduce the energy consumption and reduction of transmission power consumption. The first objective is designed to propose a new approach to improve the lifetime and throughput of the network. The motive of the second objective is to explore the capability of transmission power using data aggregation techniques in the context of wireless sensor networks. The third objective covers the average energy issue with the help of two-tier architecture. The data aggregation technique is used to save the transmission power of the network. Power level based DA which works on the power of the node. The node has higher power is responsible for the data aggregator node. A hybrid approach is used to improve the lifetime of the network. The hybrid approach is the combination of direct transmission and transmission through a cluster head. Two-tier architecture is used to reduce energy consumption in the network. Two-tier architecture is the combination of the primary tier and



secondary tier. The primary tier includes nodes those having higher RSP values and secondary tier includes nodes those having lesser RSP values.

The proposed approach in the first objective is based on direct transmission and data transmission through cluster head. The proposed approach named as a hybrid approach which is compared to the existing approaches LEACH (Low Energy Adaptive Clustering Hierarchy) and SEP (Stable Election Protocol) and found a significant improvement in terms of lifetime and throughput of the network. Three scenarios have considered, with 10% advanced nodes, 20% advanced nodes and 30% advanced nodes in the results section. The proposed approach in the second objective is based on the power level. Power level-based data aggregation technique has compared with existing approaches tree-based data aggregation, cluster-based data aggregation, chain-based data aggregation, and grid-based data aggregation. In third objective proposed approach is based on two-tier architecture. Two-tier architecture based approach has compared with existing approaches LEACH and SEP in terms of energy consumption.

## LIST OF FIGURES

Figure 1.1	WSN Model	2
Figure 2.1	Tree Based Data Aggregation	13
Figure 2.2	Cluster Based Data Aggregation	14
Figure 2.3	Chain Based Data Aggregation	15
Figure 2.4	Grid Based Data Aggregation	15
Figure 3.1	Tree Construction for DA	30
Figure 3.2	Cluster Construction for DA	31
Figure 3.3	Chain Construction for DA	32
Figure 3.4	Grid Construction for DA	32
Figure 3.5	Flow Chart of Proposed Model	33
Figure 3.6	Power Level of Nodes	35
Figure 3.7	Node Distance from Sink Node	36
Figure 3.8	Power save for Situation A (100 Nodes)	36
Figure 3.9	Power save for Situation B (100 Nodes)	37
Figure 3.10	Power save for Situation C (100 Nodes)	38
Figure 3.11	Power save for Situation A (500 Nodes)	38
Figure 3.12	Power save for Situation B (500 Nodes)	39
Figure 3.13	Power save for Situation C (500 Nodes)	39
Figure 3.14	Number of Nodes Situation Wise	40
Figure 4.1	Proposed Network Model	43
Figure 4.2	Flow Chart of Proposed Model	44
Figure 4.3	Network Throughput (A)	47
Figure 4.4	Dead Nodes (A)	48
Figure 4.5	Alive Nodes (A)	49
Figure 4.6	Network Throughput (B)	49
Figure 4.7	Dead Nodes (B)	50
Figure 4.8	Alive Nodes (B)	51

Figure 5.1	Two Tier Model for WSN	54
Figure 5.2	Flow Chart of Proposed Model	56
Figure 5.3	Average Energy for 10 Iteration	58
Figure 5.4	Average Energy in 3D for 10 Iteration	59
Figure 5.5	Average Energy for 20 Iteration	60
Figure 5.6	Average Energy in 3D for 20 Iteration	60
Figure 5.7	Number of Cluster Head in the Network	61
Figure 5.8	Number of Packets Reached at Base Station and Cluster Head	61
Figure 6.1	Heterogeneous Network	65
Figure 6.2	Flow Chart of Heterogeneous Network	68
Figure 6.3	First node dead in Different Techniques	71
Figure 6.4	Packets Reached at the Cluster Head with 100 Nodes	71
Figure 6.5	Packets Reached at the Cluster Head with 50 Nodes	72
Figure 6.6	Packets Reached at the Base Station with 100 Nodes	73
Figure 6.7	Packets Reached at the Base Station with 50 Nodes	74
Figure 6.8	Dead nodes with 100 Nodes	74
Figure 6.9	Dead nodes with 50 Nodes	75
Figure 6.10	Number of Cluster Head with 100 Nodes	76
Figure 6.11	Number of Cluster Head with 50 Nodes	76
Figure 6.12	Alive nodes with 100 Nodes	77
Figure 6.13	Alive nodes with 50 Nodes	77
Figure 7.1	Proposed Model for Throughput	81
Figure 7.2	Membership Function for Nodes	81
Figure 7.3	Membership Function for Energy	82
Figure 7.4	Membership Function for Iteration	82
Figure 7.5	Membership Function for Throughput	83
Figure 7.6	Proposed Model for First Node Dead	86
Figure 7.7	Membership Function for First Node Dead	86
Figure 7.8	First Node Dead	89
Figure 7.9	Throughput of the Network	90
Figure 7.10	Network Throughput	90

Figure 7.11	Network Throughput	91
Figure 7.12	Network Lifetime	92
Figure 7.13	Network Throughput	92

## LIST OF TABLES

Table 2.1	WSN Performance Improvement Techniques	21
Table 2.2	WSN Performance Parameters	26
Table 3.1	Simulation Parameters	35
Table 3.2	Power Transmission Save (dBm)	41
Table 4.1	Simulation Parameters	47
Table 4.2	First Node Dead	51
Table 4.3	Packets Reached at Base Station	52
Table 5.1	Simulation Parameters	58
Table 6.1	Simulation Parameters	70
Table 7.1	Simulation Parameters	88

## LIST OF ACRONYMS

ACO	Ant Colony Optimization
ALE	Average Location Error
BS	Base Station
CH	Cluster Head
CHEF	Cluster Head Election using Fuzzy
DA	Data Aggregation
DEEC	Distributed Energy Efficient Clustering
EAUCF	Energy Aware Unequal Clustering using Fuzzy
EC	Energy Consumption
E to ED	End to End Delay
ECPF	Energy aware Clustering Protocol using Fuzzy
FL	Fuzzy Logic
FLECH	Fuzzy Logic based Energy efficient Clustering Hierarchy
HEED	Hybrid Energy Efficient Distributed
IBLEACH	Intra Balanced Low Energy Adaptive Clustering Hierarchy
ICACO	Inter Cluster Ant Colony Optimization
IPSO	Improved Particle Swarm Optimization
LAUCF	Low energy Adaptive Unequal Clustering using Fuzzy
LEACH	Low Energy Adaptive Clustering Hierarchy
LEFUCMA	Low Energy Fuzzy Unequal Clustering Multi-hop Architecture
NEECP	Novel Energy Efficient Clustering Protocol
NFC	Near Field Communication
NL	Network Lifetime
PDR	Packet Delivery Ratio
PSO	Particle Swarm Optimization
RSP	Received Signal Power
RSSI	Radio Received Signal Strength Indication
SEECH	Scalable Energy Efficient Clustering Hierarchy
SEP	Stable Election Protocol
TCAC	Topology Controlled Adaptive Clustering
UWB	Ultra Wide Band

Wi Fi

Wireless Fidelity

WSN

Wireless Sensor Networks

# CHAPTER 1

## INTRODUCTION

### 1.1 Introduction

Wireless sensor networks are a combination of sensor nodes. These nodes have their own capability of transmitting the data, reception of the data and processing the data. Wireless sensor networks architecture is both types structured and unstructured. Structured architecture is more suitable for an energy-efficient manner. Mainly researcher works on the topology of the network, routing of the network, data aggregation in the network. The main aim of researchers are to improve the network lifetime, increase the network throughput, reduce the energy consumption, decrease the end to end delay, and increase the packet delivery ratio in the network. Wireless sensor networks are used in many applications. There are some issues comes into the wireless sensor network like energy efficiency, network lifetime, storage and battery backup. Data aggregation is one of the major issues in the wireless sensor network. There are so many techniques that are used in combination for data aggregation like ant colony algorithms, concealed data aggregation scheme, attribute data aggregation scheme and chinese remainder theorem. The main purpose of data aggregation is reduced the multiple data from the transmission and increase the network lifetime.

Data aggregation is one of the most popular techniques to reduce energy consumption in the network. Data aggregation reduces the redundant data from the network then aggregator node forwarded to the base station. Data aggregation improves the network lifetime, increase the network throughput, and reduce the energy consumption in the network. Sensor nodes have a limitation in terms of power. WSN is widely used in many areas like military, traffic surveillance, health care, security monitoring, battlefield, environmental monitoring, machine failure diagnoses, agriculture, transportation and many more



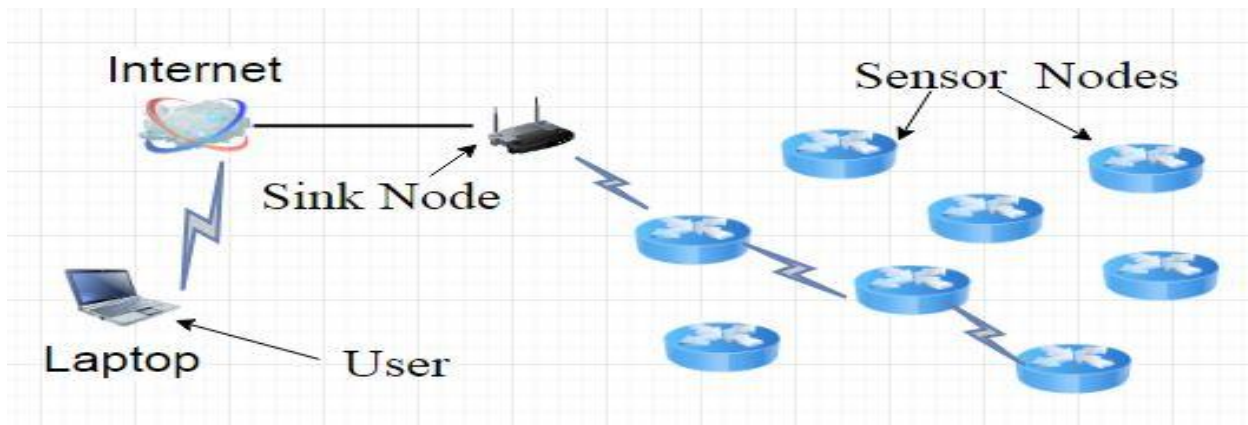

**Figure 1.1** WSN Model

In this thesis, network lifetime improvements, increase the network throughput, save the transmission power and reduce energy consumption are mainly focused. Chapter 3 explains the transmission power with DA techniques. Chapter 4, 6 and 7 includes the lifetime of the network and network throughput. Chapter 5 represents the energy consumption of the network.

## **1.2 Problem Statement**

There are challenging problems in wireless sensor networks. They are briefly identified in the following:

How to improve the network lifetime without adding extra effort in terms of energy?. What are the techniques or methods to minimize energy needs?. How to improve the network throughput without sending the redundant data. If increase in the network throughput means the number of packets reached at the base station will be increased. Energy consumption directly affects the lifetime of the network. So it must be reduced.

## **1.3 Motivation**

Wireless sensor networks are the hot research area for the last several years. It has been noticed that energy consumption is one of the most crucial issues in WSN. Several techniques, approaches, methods to reduce energy consumption are in the literature. Energy consumption directly affects the lifetime of the network. A lot of work is ongoing on the lifetime of the network and energy consumption but still, some gap is there. Data aggregation is one of the most suitable techniques to fill up the gap to improve the lifetime and throughput of the network. Performance improvements of the network are associated with following highlights.

- Scope of improving the lifetime of the network.
- Scope of improving the throughput of the network.
- Explore the data aggregation techniques.
- Scope the reduction of the power consumption of the WSN.

## 1.4 Objectives

To formulate the above research problem following objectives are designed and achieved in this thesis.

- To propose a new approach for improving the throughput and lifetime of WSN.
- To explore the transmission power capability of WSN in the context of data aggregation technique.
- To design and develop two-tier architecture for analyzing average energy issues.

## 1.5 Contributions

This thesis explores the various approaches to improve the lifetime of the network, improve the network throughput, reduce the power consumption, and reduce the average energy consumption. A hybrid approach of direct transmission of data from node to base station and transfer data with the help of cluster head is analyzed and compared with existing approaches. Designed network architecture is helpful to improve the network lifetime and throughput of the network. The contribution of this research is published as follows-

Hradesh Kumar and Pradeep Kumar Singh, “Node Energy Based Approach to Improve Network Lifetime and Throughput in Wireless Sensor Networks”, Journal of Telecommunication, Electronic and Computer Engineering, Vol. 9 No. 3-6, pp 83-88, 2017.(Scopus)

Power transmission need are reduced with the data aggregation technique. The approach is power level-based and the node that has a higher power level is selected as the cluster head and responsible for the data aggregator node. Existing approaches are network architecture based. So the power consumption of the data aggregator node is high as compare to the other node. Data aggregator node dead earlier as compare to the other nodes of the network. In the proposed approach data aggregator node is changed every iteration means node which has a higher power

level selected for the data aggregator node. The research work based on this work is published as follows-

H. Kumar, P. K. Singh, “Power Transmission Analysis in Wireless Sensor Networks Using Data Aggregation Techniques”, International Journal of Information System Modeling and Design, 9,(4), 49-66, 2018. **(ESCI, Scopus)**

Average energy reduction in the network has been done with the help of two-tier architecture. Initially checked the RSP values of the nodes. Then nodes have categorized into two-tier. The nodes that have higher RSP values come into the primary tier, those have low RSP values are come into the secondary tier. After that found the highest RSP values in both tier (primary and secondary), those selected as gateway nodes. The contribution of the research is published as follows-

H. Kumar, P. K. Singh, “Average Energy Analysis in Wireless Sensor Networks Using Multitier Architecture”, International Journal of Performability Engineering, 15, (4), 1199-1208, 2019. **(Scopus)**

The fuzzy logic-based technique has used to improve the network lifetime and network throughput of the network. Two models are designed, the first one is for network throughput and the second one is for the first node dead. Three input parameters (number of nodes, iteration number, and energy of the nodes) have taken for network throughput and two input parameters (number of nodes and energy of the nodes) are taken for the first node dead. 27 fuzzy rules are designed for the network throughput and 9 fuzzy rules are designed for the first node dead. After that proposed approach has compared with existing approaches for the lifetime of network and throughput of the network. The contribution based on this work is published as follows-

H. Kumar, P. K. Singh, “Network Lifetime and Throughput Analysis in Wireless Sensor Networks Using Fuzzy Logic”, Recent Advances in Electrical and Electronic Engineering, 13 (2), 127-135, 2020. **DOI: [10.2174/2352096512666190212152631](https://doi.org/10.2174/2352096512666190212152631)(ESCI, Scopus)**

The modified cuckoo search algorithm is implemented to calculate the first node dead, packets reached the base station and all node dead. The proposed approach has compared with existing approaches like ant colony optimization and particle swarm optimization and found better in terms

of first node dead, all node dead and packets reached the base station. The contribution of this research based on this work is published as follows-

Hradesh Kumar and Pradeep Kumar Singh, “Comparison and Analysis on Artificial Intelligence Based Data Aggregation Techniques in Wireless Sensor Networks”, *Procedia computer science*, 132 (2018) 498-506, 2018. **(Scopus)**

Data aggregation various techniques and methods are discussed in the literature survey. One of the studies on data aggregation is presented in the paper. Research gap, issues in data aggregation, challenges in data aggregation have analyzed. The contribution is published as follows-

Hradesh Kumar, Pradeep Kumar Singh, “Analyzing Data Aggregation in Wireless Sensor Networks”, 4th International Conference on Computing for Sustainable Global Development *INDIACom*, 4024-4029, 2017. **(Scopus)**

Multilevel heterogeneity has used to improve the lifetime of network and network throughput. Nodes are categorized into three categories. First, one is called super nodes those having higher energy in the network. The second one is advanced nodes those having lesser energy than the super nodes but more energy than the normal nodes. The third one is normal nodes those having lesser energy in the network. The proposed approach has compared with existing approaches in terms of packets reached sink node, first node dead, alive nodes, packet reached at cluster head and the number of cluster head at any particular iteration number and has found better. The contribution is under review as follows-

H. Kumar, P. K. Singh, “Enhancing Network lifetime and Throughput in Heterogeneous Wireless Sensor Networks”, *Wireless Personal Communications*, 2019. **(SCIE, Scopus) (Under Review)**

## **1.6 Chapter’s layout**

**Chapter 1** presents the basic introduction of the wireless sensor networks. The problem statement is discussed in this chapter. Objectives are mentioned in the chapter. Contribution of the thesis is presented in the chapter. Finally, the chapter’s layout is discussed.

**Chapter 2** provides a review of the literature. Review of literature is divided into two phases. In the first phase data aggregation based literature has discussed. In the second phase performance improvement of wireless sensor networks based review of literature is mentioned.

**Chapter 3** mentioned the data aggregation techniques (DA). The chapter includes the number of data aggregation techniques cluster-based DA, tree-based DA, chain based DA and grid-based DA. The proposed algorithm is mentioned. Flow chart of the proposed model is presented. Proposed approach power level based data aggregation (PLBDA) has compared in terms of transmission power save with existing approaches and be better.

**Chapter 4** has discussed the proposed hybrid approach which has used to improve the lifetime of network and network throughput. The chapter includes the proposed algorithm, flow chart of the proposed algorithm, proposed network architecture and results analysis. The proposed approach has compared with existing approaches LEACH and SEP in terms of packets reached sink node, dead nodes, alive nodes and found better.

**Chapter 5** tells about the average energy consumption in the network. The chapter includes the proposed algorithm, flow chart of the proposed model, assumptions in the model. Two-tier architecture has used for proposed network architecture. The proposed approach has compared in terms of average energy with existing approaches and found better.

**Chapter 6** provides the multilevel heterogeneity model to improve the lifetime of network and network throughput. The chapter includes the proposed algorithm, flow chart of the proposed model and simulation scenarios. The proposed approach is compared with existing approaches in terms of alive nodes, dead nodes, packets reached the base station, packets reached cluster head and number of cluster head at particular iteration number and found better.

**Chapter 7** mentioned fuzzy logic-based approach. The chapter includes two proposed model first one is for the network throughput and the second one is for the first node dead. Fuzzy rules for the network throughput and first node dead are reported. Finally proposed approach has compared with the existing approach in terms of network lifetime and network throughput and has found better.

**Chapter 8** has explained the conclusions and future scope of the work. This chapter concludes the work done under the chapter 3, chapter 4, chapter 5, chapter 6 and chapter 7. This chapter provides a future perspective direction for the work.

# CHAPTER 2

## REVIEW OF LITERATURE

### 2.1 Introduction

Detailed review is discussed in this chapter. The chapter contains two sections. First section tells about the data aggregation in wireless sensor networks and the second section tells about the performance improvement in wireless sensor networks.

### 2.2 Data Aggregation in WSN

This section covers the analysis of existing research papers on data aggregation in wireless sensor networks. Fetching the data from different nodes then aggregates it and forwarded it to the next level of nodes is called data aggregation. Data aggregation reduces the redundancy of the data from the network. Data aggregation improves the network lifetime.

**Lin et al.** [1] discussed aggregation on attack models. These models are used for data aggregation in wireless sensor networks. Generally, data is aggregated with the help of algebraic operations like addition multiplication or statistical operations like mean, median. **Ren et al.** [2] proposed an attribute aware data aggregation scheme. It is more flexible in point of view size, tracking of mobile events. Data fusion is mostly used for hierarchical transformation which is based on intensive computing. Intensive computing is expensive in wireless sensor networks as compared to others. Generally, events in wireless sensor networks are spatially and temporally correlated. Most of the work is based on homogenous packets and static routing but they have used dynamic routing for heterogeneous packets. **Campobello et al.** [3] explained a new algorithm for data aggregation, which is based on the chinese remainder theorem. It is suitable for the dense wireless sensor network. **He et al.** [4] discussed the load-balanced maximal independent sets, connected maximal independent sets and LBDAT construction problem. LBDAT is an NP-complete problem while LBMIS is an NP-hard problem. Their work is based on data aggregation technique, three types of scheduling algorithms minimum latency aggregation scheduling, energy-efficient

aggregation scheduling and maximum lifetime aggregation scheduling have considered in their paper.

**Roy et al.** [5] have explained the partial data aggregation model for tree construction methods. The sum and count are important functions come under data aggregation. Attack resilient computation algorithm includes two terms called as first phase and second phase. In the first phase, the base station derives minimal authentication information, the second phase base station requires more authentication information. **Bagaa et al.** [6] discussed that the main goals of data aggregation are energy efficiency, reducing data propagation latency, data accuracy, aggregation freshness and avoidance of collisions. The main components of data aggregation are aggregation function, routing scheme, and data aggregation scheduling. The output of data aggregation is a single value when aggregation function MAX or MIN is used.

**Zhao et al.** [7] have discussed the conventional data aggregation scheme. It is unable to handle of huge amount of data in traffic. Compressive sensing comes commonly helpful in sparse networks which are unordered in nature. The traditional compressive sensing based scheme faces two problems first one less efficient, node density, the complexity of topology and second one find the transformation of vector signal in sparse networks. **Wan et al.** [8] discussed angular routing and region for queries. They have divided angular routing into sub-regions with the help of LEACH. Users are allowed for declarative queries with Tiny-SQL query language. In this scenario sink node and root node works as the same node. Sink node cannot move in the real-time scenario but the sink node replaces by another node with respect to time. Work is analyzed based on sample queries multi-point to single point and point to point in their paper.

**Sert et al.** [9] explained the protocol for WSNs based on the fuzzy logic with the help of distributed two-tier architecture. Leaf nodes send the data to the non leaf node (cluster head) and non leaf node transfer the data to the sink node. Their algorithm is the combination of clustering and routing. In the first-tier, selection of cluster head takes place and in second-tier routing take place (data transfer from the source node to the sink node). Clustering is based on three parameters first one is the node energy, the second one is the distance of the node from the base station and the third one is the relative connectivity of node. **Wu et al.** [10] discussed the analysis in wireless sensor networks for converging cast. End to end delay depends on the path duration of the network. Authors compared the one-hop duration time and two-hop duration time. Simulated results are



validated with qualnet simulator. They have taken area for the simulation is 3000m \* 3000 m in their paper.

**Chen et al.** [11] presented the aggregation for duty-cycled sensor networks based on the latency. The problem of minimum latency aggregation is sorted out only when all sensor nodes are awake. The duty cycle means nodes are awake only when the action is required. So sensor nodes work some times as sleep mode and sometimes active mode. Sensor nodes can receive or transmit the data when sensor nodes are active only. Many techniques for maintaining the aggregation latency even changes in the network topology have also discussed. Networks have two states first one is the dormant state and the second one is the active state. Dormant state means sensor nodes are in sleep mode and active state means sensor nodes are in active mode. **Wang et al.** [12] explained the packet aggregation in WSNs. Packet aggregation is one of the most important techniques to improve the energy efficiency and reliability of the industrial wireless sensor networks. The authors have proposed an algorithm for packet aggregation based on a distributed and centralized manner. Packet aggregation technique is used TDMA for packet transmission. So each and every sensor nodes send the data in their respective time slots. Two approaches optimal aggregation scheme and least effective relay aggregation are used in a centralized manner for packet aggregation.

**Zhang et al.** [13] analyzed a technique based on data aggregation for wireless sensor networks. Many researchers have done work on in-network aggregation where N packets are aggregated into M packets ( $1 < M < N$ ). Ring based approach is used to validate the results. Basically, the networks divide into the number of rings and then data aggregation applied to ring by ring from outside to inside. Network reliability maintain with the help of unicast data forwarding to the next-hop node. The number of copies forwarded to the next-hop node increases the reliability of the networks. This scenario increases the communication cost of the networks. **Nguyen et al.** [14] explained the issues, performance and design architecture for multi-channel wireless sensor networks with the help of minimum latency aggregation. Aggregation scheduling is one of the very important term for data aggregation. The main activity of the data aggregation is merging the packets into one packet and generally topology of the networks is tree structure. To improve the network latency network should be centralized but in real-time scenario networks are distributed. Sensor nodes do not aware of all other sensor nodes in terms of knowledge in a distributed system.

**Pavani et al.** [15] discussed the DA with the two-fold method for routing in WSNs. In the recent era, network lifetime improvement is one of the most important challenges in WSNs.  $E^2R^2$  routing algorithm has used to reduce the energy consumption in WSNs.  $E^2R^2$  Routing algorithm has designed in a hierarchical manner that's why the time complexity and computation cost of the system have increased. To overcome these problems a new has concept came called the ring partitioned MAC. Basically, energy consumption is reduced in three phases clustering phase routing phase and aggregation phase. **Wang et al.** [16] proposed the compressive sensing based aggregation in WSNs. A matrix generated for the network with all sensor nodes when some new nodes enter into the network then matrix updated with new values. Two methods have discussed as initial point selection method and constraints convexification method for the compressive sensing aggregation. These two methods have further compared with simple Gaussian and optimal Gaussian to calculate the ratio data recovery and expanded the capacity of the networks.

**Tang et al.** [17] presented a query aggregation model based on multi-region for wireless sensor networks. Spatial tree index is used the find out the sensor nodes which is participating in the network or not. The index also tells about the accuracy of the sensor nodes. The authors have proposed the energy-efficient model for a multi-attribute spatial index tree. This approach mainly focused on the recombination of the query regions. The density-based model has extended for multiple regions and multi-sensor has called the density-based spatial clustering algorithm (DBSCAN). The main motto of the DBSCAN is to find out the high density and low-density region. **Lin et al.** [18] discussed the aggregation problem to find out the maximum lifetime in wireless sensor networks. Collecting the information from the sensor nodes in data aggregation tree problem is an NP-hard problem. The network scenario is designed in such a way so that the power transmissions of sensor nodes are adjustable and all nodes are considered heterogeneous. Even this is not happening in the real-time scenario that the maximum transmission power gave the maximum network lifetime. Anyone sensor node's energy becomes the zero is considered the network lifetime. Basically, this type of network lifetime is applicable in mission-critical applications.

**Kang et al.** [19] discussed the aggregation scheduling for the duty-cycled wireless sensor networks. An algorithm is designed in delay efficient manner. Network delay, energy consumption, network lifetime are the most significant challenges in the wireless sensor networks.

To sort out these challenges duty cycle is one of the most crucial techniques. Duty cycle means sometimes sensor nodes are active and some time sensor nodes are sleeping accordingly usages. Algorithm contains the two phases first one is the tree construction using data aggregation and second one is the scheduling for the data aggregation with the help of econ.

**Alinia et al.** [20] proposed a tree construction algorithm for aggregation based on the deadline in WSNs. The quality of aggregation depends on the number of sensor nodes that are participating in the aggregation process. Maximum achievable of aggregation is  $O(2^D)$ .  $D$  represents the deadline. Optimal aggregation tree construction problem is an NP-hard problem. Generally, a network consists of the source nodes and non source nodes. A tree construction in such a way so that minimum numbers of non source nodes are included in the tree is called optimal tree aggregation. Markov approximation framework has used for the tackle tree construction.

**Ren et al.** [21] proposed the distributed aggregation scheduling for wireless sensor networks. Data aggregation for dense networks work as a time consuming so to reduce the time people are looking for the data aggregation latency. Sometimes it happens that a data conflict arises in the network so to avoid this problem all sensor nodes are equipped with one radio. Within one cluster all sensor nodes have used a single radio model and those nodes are in different cluster used different radio model.

**Nguyen et al.** [22] discussed the collision-free and minimum latency based algorithm for data aggregation in WSNs. When data aggregation term comes in mind than two main aspects are arises that is data latency and data collision. Most of the researchers have focused on data latency. Numbers of packets are allowed to merge into a single packet cause of data collision. One of the best solutions for the same problem is tree construction. Data aggregation without data collision means fixed numbers of packets are allowed to merge in a single packet. To overcome the latency and collision an algorithm DA scheduling has used.

**Akyurek et al.** [23] discussed the aggregation scheduling based on the packet in WSNs. To achieve better energy efficiency, resource utilization and spectral efficiency optimal packet aggregation are used. Authors have provided the framework for the utility function based on the different applications. A gain function is used for the optimal aggregation time. Concept of delay arises in multi-hop communication. An intermediate node receives the data from previous nodes

and aggregates it before forward to the next node. Optimal packet aggregation considers three-level optimization application data stream, packet, and network conditions.

**Boubiche et al.** [24] explained the strategies for data aggregation in wireless sensor networks. DA plays an important role in WSNs when big data is used. There are only 3 vs in big data but nowadays there are 9 vs, but mainly there are 5 vs volume, velocity, variety, value, and veracity. Hadoop is one of the most important tools for big data. There some important in big data challenges in WSNs like processing the data, securing the data, clustering the data and to save energy in the networks.

From the above literature analysis, four categories of data aggregation techniques have identified such as tree-based, cluster-based, chain-based and grid-based data aggregation techniques. These four techniques are discussed in detail in the next section 2.3.

### 2.3 Data Aggregation (DA) Techniques

This section comes the data aggregation techniques and their related challenges in context to WSN. These data aggregation techniques have their own advantages and disadvantages.

#### 2.3.1 Tree-Based Data Aggregation

In tree-based data aggregation, the network is designed in a tree structure. Leaf nodes sense the data and transfer to the intermediate node or parent node. Data aggregation takes place at the intermediate nodes. Root node works as the sink node. Finally all data has receipted at the root node.

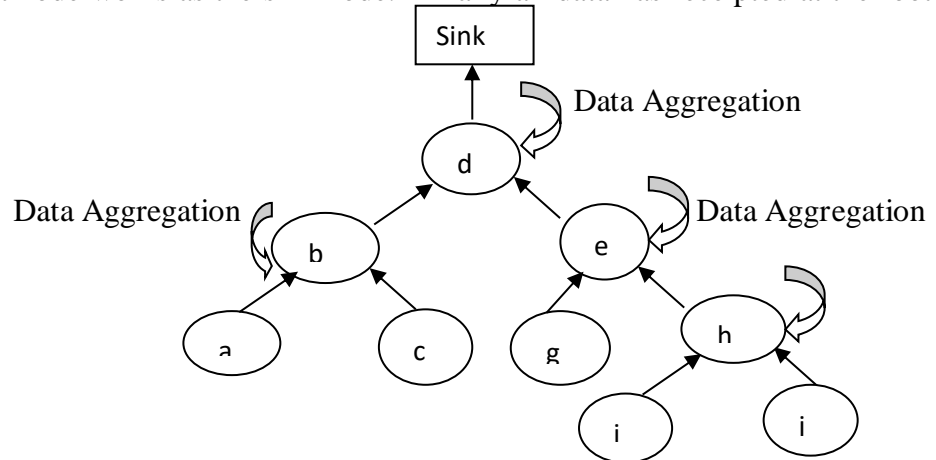
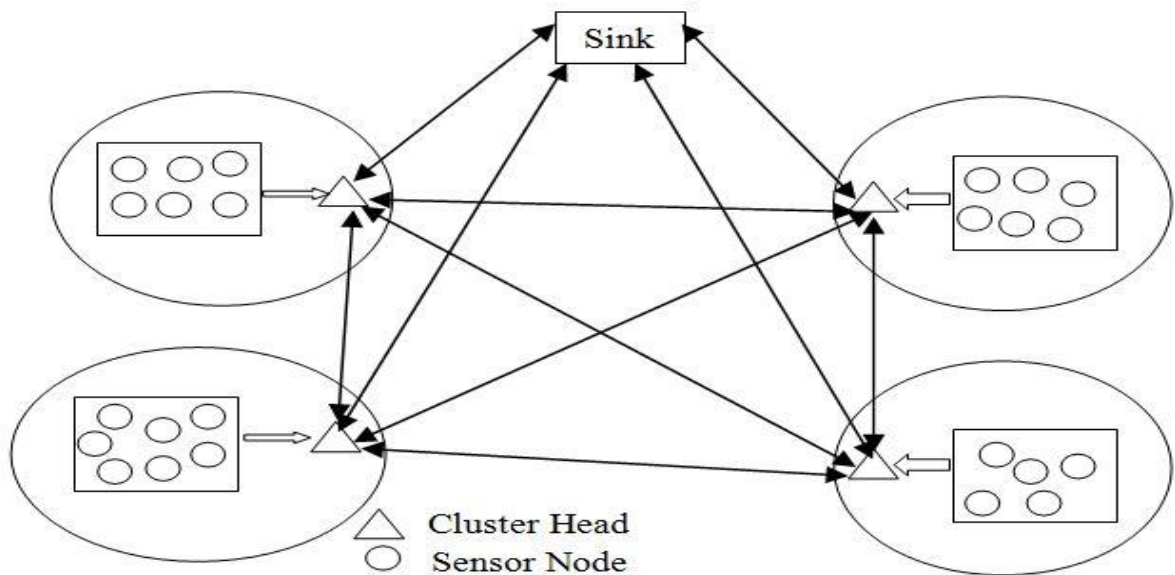

**Figure 2.1** Tree-Based Data Aggregation

Figure 2.2 shows the tree-based data aggregation. Non-leaf nodes work as a data aggregator node. Root node works as a sink node as per architecture shown in figure 2.2.

### 2.3.2 Cluster-Based Data Aggregation

In cluster-based data aggregation, the network is divided into the number of clusters. Each cluster has a cluster head in cluster-based data aggregation in WSN. Nodes transfer data to the cluster head and the cluster head aggregates the data and then transfer to the other cluster head or to the base station.



**Figure 2.2** Cluster-Based Data Aggregation in WSN

Figure 2.4 illustrates the cluster-based data aggregation. Small circle represent the node, small triangle represent the cluster head. The top small rectangle represents the sink node. Nodes transfer data to the cluster head and the cluster head aggregates the data and then transfer to the other cluster head or to the base station.

### 2.3.3 Chain Based Data Aggregation

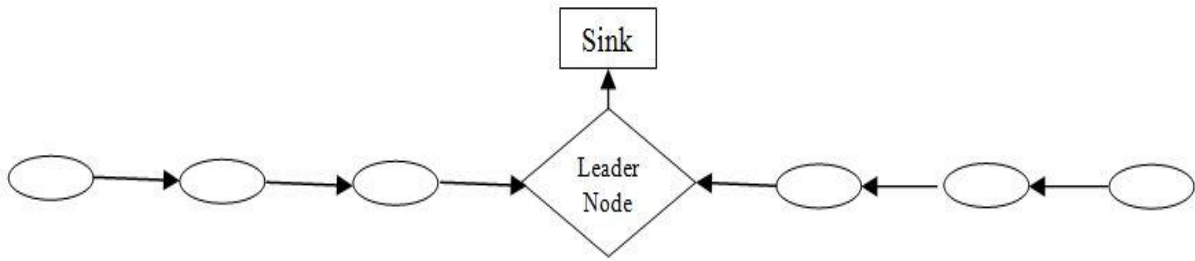

**Figure 2.3** Chain Based Data Aggregation

Figure 2.5 shows the chain based data aggregation. A leader node works as a cluster head, it collects the data from all nodes and aggregates it then transfer to the sink node.

### 2.3.4 Grid-Based Data Aggregation

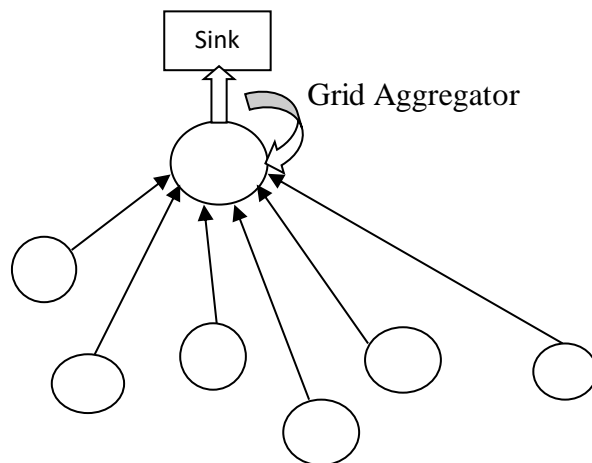

**Figure 2.4** Grid-Based DA

Figure 2.6 shows the grid-based data aggregation. The grid aggregator node is responsible for the data aggregation.

In the next section, a review of literature on performance improvement in wireless sensor networks is discussed. The next section categorized into two parts. First part contains has reviewed based on different techniques in wireless sensor networks and the second part contains has reviewed based on a fuzzy logic approach.

## 2.4 Performance Improvement in WSN

Network lifetime, the throughput of the network, energy consumption, power consumption, end to end delay, latency of the network are the performance parameters of wireless sensor networks. Network performance depends on the number of parameters like an area of the network, the number of the nodes in the network, initial energy of nodes, the transmission range of the nodes etc.

**Lu et al.** [25] proposed a multipath routing protocol for WSNs. They have also proposed a load balancing algorithm, to allocate the traffic to each path optimally. Lower average delay, control the overhead, direct diffusion and directed transmission and N-1 multipath routing are the important parameters in their paper. This work has been improved with the support of limited nodes mobility. **Tian et al.** [26] have proposed a coverage preserving node scheduling scheme. They have worked on the extension of node sensing so that sensing coverage is not more than 1%, this rule is called as off duty eligibility rule. Weather and obstacles may affect the sensing area which may be irregular and asymmetric but actually, it should be a symmetric circle.

**Lippi et al.** [27] discussed hierarchical sample techniques that are practicable when system units are able with numerous sensors observing the identical occurrence. Most of the energy-efficient methods are in single directed either temporal or spatial but the combination of both is more suitable or optimal that is called Spatio-temporal. Adaptive sampling is more preferable when techniques are event-driven. When energy sources are predictable then Harvesting-aware adaptive sampling is more suitable. Model-based active sensing is preferable when sensor networks are computationally expensive. **Chen et al.** [28] studied the single level aggregation of wireless sensor networks. They explained the total energy consumed by the wireless sensor network can be reduced by using some networking protocols. Same work also has extended with the help of mobility aggregators.

**Rezaei et al.** [29] discussed the data prediction approaches in networking processing. They explained two techniques namely duty cycling and data-driven approaches. Duty cycling mainly focusing on the networking subsystem. They also explained some protocols for wireless sensor networks. **Lin et al.** [30] maintained the family of ant colony algorithm also known as DAACA which includes three phases like packet transmissions, operation on phenomena and initialization.

DAACA is better than other techniques in the following point of view: one-hop transmission, energy efficiency, computation complexity and average degree of nodes. They have used Java for network simulation and result analysis.

**Panigrahi et al.** [31] reported one of the issues in a wireless sensor network is data transfer from the source node to the sink node without conflicting other data, that's why a technique called as conflict-free periodic data aggregation technique. Simulation result is better as compare to others; conflict-free periodic data aggregation is validated with network simulator-2. It is also better for low power sensor nodes. Future work may be based on priority-based periodic data aggregation technique. **Acharya et al.** [32] proposed a new approach for fault-tolerant called NFOM (neuro-fuzzy optimization model) which is based on NFIS (neuro-fuzzy inference system) estimator for wireless sensor networks. NFIS scheme works well for both type of clustered networks (inter-cluster or intra-cluster) in the detection of fault data aggregation. The given technique first find out the faulty cluster head and forward it towards the high energy gateway node. After that high energy gateway node works as a fault detection manager. Results have compared with other fault detection techniques like distributed fault detection, low energy distributed fault detection, majority voting, fuzzy knowledge-based fault tolerance, etc.

**Latha et al.** [33] proposed a data aggregation scheme for improving the network lifetime for distributed sensor networks. The authors have used three-fold integration for the neighbor selection. Packet delivery ratio, control overhead, transfer rate, and energy consumption are calculated as performance parameters. **Dattatraya et al.** [34] presented a method for cluster head selection in wireless sensor networks. Model is the combination of glowworm optimization and fruitfly algorithm. Network lifetime and quality of service have improved with the help of this model.

**Brar et al.** [35] discussed the two-tier node deployment in wireless sensor networks. There are two types of nodes in the networks. First one is regular nodes and the second one is energy harvesting relay nodes. Layered architecture has categorized based upon the number of layers. Each layer has uniformly regular nodes but energy harvesting nodes depend on the load factor in a layer.



**Yildiz et al.** [36] discussed the packet size optimization technique for the network lifetime improvement. Large packets have more chances of high packet error rate and more energy consumption also. But in case of small packet transmission more frame should be transmitted so numbers of fragmentation are increases. **Pavani et al.** [37] presented two fold data aggregation technique for wireless sensor networks. Results have analyzed with the help of NS-3 simulator. Chicken swarm optimization has used for inter clustering. Network lifetime improvement depends on four parameters MAC scheduling, cluster formation, routing and data aggregation.

**Dutt et al.** [38] discussed the impact of the size variation of a packet on sensor networks. Packet length have played a vital role in the energy consumption of wireless sensor networks. The impact of the variable length of the packet has analyzed in both ways with a stationary base station and the mobile base station. **Redhu et al.** [39] presented an improvement of the network lifetime with mobile sink scheduling. A landmark assisted mobile sink is designed for wireless sensor networks. Initially, a random walk has used in the network after that kalman filter framework has applied in the network. This type of combination basically is used for cyber-physical system applications.

**Saranraj et al.** [40] proposed a cluster head selection algorithm for WSNs. Clustering is one of the most important techniques for improving the network lifetime in WSNs. Optimal cluster head selection is very important in terms of energy consumption. **Sharma et al.** [41] explained the heterogeneity in wireless sensor networks. Generally, the homogenous network considers but to improve the network lifetime or in a real-time heterogeneous network is more suitable for network lifetime improvement. Heterogeneous networks consider different types of heterogeneity like energy heterogeneity, link heterogeneity, computation heterogeneity, etc.

**Heinzelman et al.** [42] proposed a novel LEACH approach in WSN. LEACH has compared with the direct transmission in terms of energy efficiency. LEACH has used randomized cluster head rotation in the network. Data fusion applies to decrease the information transmitting gateway node. Cluster head dead early, so to solve this problem leach protocol is used. LEACH computes local data fusion before data transmission for the gateway node to increase the system lifetime. **Handy et al.** [43] projected an approach to extend the system life span in conditions of first node dead, half nodes dead and last node dead. The proposed scheme improves the network lifetime by 30% in comparison to the existing LEACH protocol. Using the proposed scheme network lifetime has increased up to 30% for the first node dead meanwhile network lifetime increased by 20% for half

node dead. They have performed simulations in two parts. In the first case, the base station positioned at (100,300) and in second case base station positioned at (100,500). It is reported that the network showed a better lifetime, when the base station positioned at (100,300).

**Younis et al.** [44] discussed the HEED approach, which depends on the remaining energy of the network and overhead of a node. The approach is well supported for scalable data aggregation. HEED algorithm terminates at  $O(1)$  iterations. Worst-case complexity for processing is  $O(n)$ , where  $n$  is the number of sensor nodes in the system. Nodes are equally significant and quasi-stationary in the network. One of the specific features of this networks, that each node is having multiple powers for transmitting the data.

**Smaragdakis et al.** [45] explained a SEP approach. It is called a stable election protocol based on the heterogeneous network. SEP consists of some percentages of nodes having more energy as compared to the rest of the nodes. The authors mentioned that one of the crucial parameters for the reliability of the network is steadiness time, which is termed as the moment before the death of the first node. Weighted election probability is used for the choice of bunch leader in SEP depending on remaining energy. **Qing et al.** [46] explained the DEEC approach for assorted WSNs. Bunch leader selection depends on the residual power of the node and the standard power of the network in DEEC. So, in this approach, the sensor nodes which are having additional remaining power get a high chance to become bunch leader. The initial energy of every node is equal in the homogeneous network but not in the heterogeneous network. Advanced nodes have higher initial energy as compare to the normal nodes in the heterogeneous networks.

**Kim et al.** [47] analyzed an approach named as bunch leader selection technique using fuzzy logic. This approach is 22.7% more proficient as compared to the LEACH protocol. The disadvantage of LEACH energy distribution among the sensor nodes is negligible. Bunch leader selection using fuzzy logic has received the information from some specific sensor nodes instead of all sensor nodes. Cluster head selection is based on localized information in the CHEF technique. **Taheri et al.** [48] have explained ECPF approach. Basically, this approach is the combination of three techniques; fuzzy logic, non-probabilistic bunch leader selection and on-demand clustering. The nonprobabilistic CH election is based on inversely relative to the remaining power level of sensor nodes in the network. Fuzzy logic is used to determine the final cluster head from all tentative cluster heads.

**Dahnil et al.** [49] proposed the TCAC algorithm. This technique has the power to adjust the power level and degree of connectivity of the system. TCAC is better as compared to the HEED and EECS. Topology controlled adaptive clustering approach consists of three phases; bunch leader selection, periodical update, and bunch creation. Cluster head depends on the transmission range in the network. A number of CH is less when the transmission range is high otherwise the number of cluster head is more if the transmission range is low. **Bagci et al.** [50] discussed the EAUCF approach using fuzzy logic. Bunch leaders which are near to the gateway node die earlier as compared to the bunch leaders who are distant from the gateway node. This problem is called a hot spot. Unequal clustering portioning technique is used to overcome this problem. The main motive of EAUCF is to reduce the overhead of the intra-cluster in cluster heads near to the gateway node or having the low energy level of the battery.

**Salim et al.** [51] analyzed intra balanced LEACH (IBLEACH) it is the improvement on LEACH. Intra balanced LEACH approach is compared with LEACH, ELEACH, LEACHB, TLEACH and VRLEACH (variable round LEACH). **Kim et al.** [52] explained the inter-cluster ACO (ICACO) algorithm which is based on the concept of ACO. IC-ACO is compared with one of the popular LEACH protocol. IC-ACO algorithm has two phases; (i) first phase nodes have classified into bunches and then selection of bunch leader, (ii) in second phase routing performed is based on ACO and minimization of transmission data.

**Tarhani et al.** [53] explained the SEECH approach. Sensor nodes having a high degree are chosen as a cluster head and at the other side's nodes containing fewer degree are considered as relays nodes. The distance-based algorithm is used in a scalable energy-efficient clustering hierarchy approach. SEECH is compared with TCAC and LEACH in terms of energy expenditure and the number of alive sensor nodes. SEECH calculates some parameters like distance from a node to sink and degree of node etc. before starting the first round. **Jia et al.** [54] discussed DCHSM for WSNs. DCHSM have improved the network lifetime up to 50% as compare to LEACH. However, it has further improved the system life span by 30% as compared to the DEEC. Bunch leader selection is completed into 2 phases for DCHSM; in primary stage bunch leader, selection depends on the perceived possibility and in second phase bunch leader selection based on survival time estimation. DCHSM has compared with DEEC, LEACH, EBDC, and AEOC in terms of death nodes, alive nodes, network coverage and average residual energy.

**Balakrishnan et al.** [55] analyzed FLECH used for non-uniform WSNs. Bunch leader election depends on parameters of a node like remaining energy, distance to the gateway node and node centrality using a fuzzy logic-based clustering hierarchy. FLECH has compared with MOFCA (multi-objective clustering fuzzy approach), EAUCF, LEACH, ECPF and CHEF. **Zhou et al.** [56] explained a novel method to improve the system life span using improved PSO. They compared their work with a number of existing approaches in different scenarios like the area of the network, the position of the base station and the number of nodes. Improved particle swarm optimization approach has followed 2 stages; information transmission stage and clustering setup stage. Both stages may periodically take place in each round.

**Singh et al.** [57] discussed a multilevel model for heterogeneous wireless sensor networks. There are two types of parameters are used primary parameter and the secondary parameter. A multilevel approach is applied to HEED protocol and analyzed a number of packets reached at the base station and a number of alive nodes in the networks. Singh proposed an energy-efficient model for heterogeneous wireless sensor networks. Designed model is based on a cluster head and residual energy of the network. They have considered up to 6 levels in their work. Network lifetime, average delays in the network and traffic load have analyzed in their work.

There are several techniques to improve the performance of WSN. Table 2.1 illustrates some of the techniques of performance improvement. The papers have been considered since the year 2000 to 2017 to maintain the table 2.1.

**Table 2.1** WSN Performance Improvement Techniques

<b>S. No.</b>	<b>YEAR</b>	<b>AUTHOR NAME</b>	<b>TECHNIQUE</b>	<b>WORK DONE</b>
1	2000	Heinzelman et al.[42]	LEACH	Cluster head dead early, so to solve this problem leach protocol is used.
2	2002	Handy et al.[43]		Using the proposed scheme network lifetime increased up to 30% for the first node dead meanwhile network lifetime increased by 20% for half node dead.
3	2004	Younis et al.[44]	HEED	The approach is well supported for scalable data aggregation.
4	2004	Smaragdakis et al.[45]	SEP	SEP consists of some percentages of nodes having more energy as compared to the rest of the nodes.

5	2006	Qing et al.[46]	DEEC	Bunch leader selection depends on the residual power of the node and the standard power of the network in DEEC.
6	2008	Kim et al.[47]	CHEF	Cluster head selection in CHEF based on localized information in the network
7	2012	Taheri et al.[48]	ECPF	This approach is the combination of three techniques; fuzzy logic, non-probabilistic bunch leader selection and on-demand clustering.
8	2012	Dahnil et al.[49]	TCAC	This technique has the power to adjust the power level and degree of connectivity of the system.
9	2013	Bagci et al.[50]	EAUCF	The main motto of EAUCF to reduce the overhead of the intra-cluster in cluster heads near to the gateway node or having the low energy level of the battery.
10	2014	Salim et al.[51]	IBLEACH	Intra balanced LEACH approach is compared with LEACH, ELEACH, LEACHB, TLEACH, and VRLEACH.
11	2014	Kim et al.[52]	ICACO	IC-ACO algorithm has two phases; (i) first phase nodes are classified into bunches and selection of bunch leader, (ii)in second phase routing performed is based on ACO and minimization of transmission data.
12	2014	Tarhani et al.[53]	SEECH	The distance-based algorithm is used in a scalable energy-efficient clustering hierarchy approach.
13	2016	Jia et al.[54]	DCHSM	Bunch leader selection is completed into 2 phases for DCHSM; in primary stage bunch leader, selection depends on the perceived possibility and in second phase bunch leader selection based on survival time estimation.
14	2017	Balakrishnan et al.[55]	FLECH	FLECH used for non-uniform WSNs.
15	2017	Zhou et al.[56]	IPSO	Improved particle swarm optimization approach followed 2 stages; information transmission stage and clustering setup stage.
16	2017	Singh et al.[57]	NEECP	Novel energy-efficient clustering protocol used for improves the network lifetime. NEECP used in two ways with aggregation and without aggregation.

Table 2.1 shows the different techniques of performance improvement in WSN. The papers are considered for this table from the year 2000 to the year 2017. LEACH approach is more popular out of all these approaches.

**Tabatabaei et al.** [58] proposed an algorithm combination of fuzzy logic and lion pride optimizer. Lion pride optimizer algorithm has used for clustering. Results have compared with the IEEE 802.15.4 protocol and Fuzzy logic in terms of end to end delay, throughput and delay in multimedia files. **Robinson et al.** [59] explained the clustering approach in WSN using neuro-fuzzy. Neuro-fuzzy means a combination of fuzzy logic and neural network. The power of node, memory, and processing speed are the input variables for the fuzzy logic. Some assumptions are taken into account like the distance of the node from the sink node calculated on the bases of received signal strength and coordinator node placed accordingly suitability. The neural network is used for the selection of bunch leader in the network. **Jain et al.** [60] explained the graph-based technique for WSN using fuzzy logic. Basically, the graph represents the neighbor nodes in the network so that easily identify the nodes in the groups. A metric is designed to calculate parameters in the networks (the centrality of the group, residual energy, hop distance etc.). The uncertainty of energy depletion of the network i.e nonuniform energy consumption makes the network dynamic nature. This type of issue has been solved by using relay nodes.

**Koosheshi et al.** [61] proposed unequal clustering approach using fuzzy logic. Nodes that are closer to the coordinator node consumes more energy as comparison nodes that are far from the coordinator node. The nodes which are closer to the coordinator node, those die earlier. The whole network has divided into small sub-areas and mobile coordinators nodes are used. So that the distance of a node from the coordinator node is reduced indirectly way can say energy consumption is reduced. The energy hole problem also solved with this approach. **Mao et al.** [62] proposed an improved clustering approach using fuzzy logic. This approach is suitable for large-scale WSNs. ACO approach is used for routing from node to coordinator node. The approach is suitable for solving the hot spot problems in multi-hop wireless sensor networks. The approach has compared with LEACH, EEUC, and CHEF in terms of network lifetime and energy consumption.

**Mirzaie et al.** [63] discussed the fuzzy approach for heterogeneous WSN. This approach has used a doorstep value for the selection of bunch leader. So it may be possible some rounds the same bunch leader work as bunch leader. The selection of bunch leaders depends on input parameters

(remaining energy, distance to coordinator node and a number of neighbors). The authors have completed their work in two scenarios. In the first scenario, the area is 100 by 100  $M^2$  and the number of nodes is 100. In the second scenario, the area is 200 by 200  $M^2$  and the number of nodes is 200. Energy consumption reduced and network lifetime is increased in their paper. **Neamatollahi et al.** [64] discussed a solution for the hot spot problem in WSN with the help of fuzzy logic. During data aggregation when traffic load suddenly increases on a particular node then that nodes dead. So load distribution should be uniform in the network for better energy utilization in the networks. Fuzzy logic has used manage the radius for the bunch leader. The generally small size of groups in the network may reduce energy consumption.

**Nokhanji et al.** [65] presented on demand clustering approach for nonuniform WSN with the help of fuzzy logic. Bunch leader selection is based on node centrality and node degree. Normally clustering has two phases cluster setup phase and steady-state phase. Out of these two phases cluster set up phase consumes more energy as compared to the steady-state phase. A combination of inter-cluster and intracluster approach has used in their work. **Ortiz et al.** [66] presented an approach for route assignment and route maintenance in WSN with the help of fuzzy logic. Simulation has performed in omnet++. They have compared their work with a simple tree routing approach. Working of simple tree routing is completed into three steps. In the first step coordinator node announces all over the network then in the second step all nodes those received the announcement reply in the form of a message. In the third step, this procedure continues until the whole network covered.

**Phoemphon et al.** [67] analyzed the global positioning approach for sensor nodes with the help of fuzzy logic and extreme machine learning. Extreme machine learning works based on deep learning. Deep learning mostly is used in image recognition, handwriting recognition. Very few researchers have used this technique in wireless sensor networks for node localization. Node localization has affected by a number of regions like sensing coverage, node density, topology diversity, etc. **Sharma et al.** [68] discussed the 3-D localization approach for nodes in WSNs using fuzzy logic. Bacterial foraging optimization and inverse weed optimization two techniques have used for 3-D node localization. Received signal strength is the dominating parameter to calculate the power of a node to transmit the data from one node to another node. The authors have compared

their work with the centroid method, existing 3-D approach and weighted centroid method in terms of positioning coverage, localization accuracy, and stability.

**Baccar et al.** [69] discussed the localization approach using fuzzy logic. The location of mobile nodes can be calculated with the hierarchical fuzzy approach. The whole network has divided into subregions based on a fuzzy location indicator. Each region indicated by a fuzzy set. Radio signal strength is calculated with the help of anchor nodes. Radio signal strength indication processed by fuzzy inference rule then aggregation applied on it. Finally, defuzzification takes place and provides the crisp value for the localization of mobile nodes. **Abdolmaleki et al.** [70] presented a protocol based on fuzzy for topology discovery. The motto of the work is improving the efficiency of WSNs. Network lifetime increased by 45% and packet loss has decreased by 50%. Network architecture consists of two types of plane, data plane and control plane. Data plane includes the number of sensor nodes, however, the control plane consists of a host node that is not part of WSN. Cost of the node is calculated as the output of the WSNs on the bases of input parameters (Remaining energy, queue length and a number of neighbors).

**Adhikary et al.** [71] presented an approach to improve energy efficiency and equal load distribution over the networks with the help of clustering. CH selection is based on fuzzy logic in their work. Basically fuzzy logic simplifies the problem of vagueness in WSNs. First order of energy consumption model is used for energy consumption calculation. Mamdani model is used for a fuzzy inference system to solve the ambiguity. The fitness value of the system is based on centrality, a number of neighbors and remaining energy. **Dutta et al.** [72] discussed fuzzy c mean to balance the load over the WSNs. Network model assume to be each and every node is busy to transmit the data until the dead or some other failures occur in the network. A number of cluster head plays a vital role in the energy consumption in the network. The number of cluster heads is inverse propositional to the energy consumption in the network. Means if numbers of cluster heads are more than energy consumption is less. First node dead, half node dead, data transfer rate and throughput have analyzed with different existing approaches (LEACH, TEEN, SEP, CHEF etc.).

**Gajjar et al.** [73] analyzed multi-hop architecture for WSN using fuzzy-based clustering. Network divided into a number of layers to find out the neighbor nodes. Two steps have considered in their work; steady-state and neighbor finding. Every node broadcasts their location, node id, and



message. Steady-state further divided into subparts like cluster head selection, fuzzification, packet reception, etc. Hotspot problem, scalability of the network and energy of the nodes are the main terms those are kept in mind when multi-hop cluster routing is applied in the networks. **Julie et al.** [74] discussed the routing protocol using Fuzzy which includes two steps. Construction of bunch leader takes place in the first step. The main work of bunch leader is an improvement in energy efficiency and fault tolerance. Improvement of network lifetime and energy optimization takes place in the second step. Residual energy distance of the node from the sink node is the input parameters for the fuzzy system. A node which works as a bunch leader called a gateway. Bunch leader is select randomly after that in second round bunch leader selection based on the fuzzy logic rule.

Table 2.2 represents the number of performance parameters of WSN. Abbreviations are used in the table are as follows

- FL Fuzzy Logic                      NL Network Lifetime                      EC Energy Consumption
- T Throughput                      G Goodput                      L Latency
- PDR Packet Delivery Ratio                      E to ED End to End Delay
- ALE Average Location Error

**Table 2.2** WSN Performance Parameters

Ref.	Techniques	Parameters							
		NL	EC	T	G	L	PDR	E To ED	ALE
[59]	✓	✓		✓					✓
[60]	✓		✓	✓					
[61]	✓	✓	✓						
[62]	✓	✓	✓	✓					

[63]	✓	✓		✓	✓	✓			
[64]	✓		✓				✓	✓	
[65]	✓	✓						✓	
[66]	✓	✓	✓						
[67]	✓	✓	✓						
[68]	✓	✓	✓						
[69]	✓	✓							
[70]	✓	✓	✓						
[71]	✓	✓	✓						
[72]	✓		✓	✓					
[73]	✓								✓
[74]	✓								✓

Table 2.2 shows the performance parameters of the WSN. The table includes the papers based on the fuzzy logic approach.

## **2.5 Summary**

It is identified that data aggregation and performance improvement are two open issues in wireless sensor networks. In this chapter discussed review literature has two phases. In the first phase, a literature review has discussed on data aggregation in WSNs. In the second phase, a literature review has discussed on the performance improvement of wireless sensor networks. Various techniques come into literature to improve the performance of wireless sensor networks. Some of these are discussed in table 2.1. The techniques are considered in table 2.1 from the year 2000 to 2017. Two issues are mainly addressed in this thesis from chapter 3 to chapter 7.

# CHAPTER 3

## DATA AGGREGATION IN WSN

### 3.1 Introduction

In wireless sensor networks, energy consumption is one of the most prominent issues. Energy consumption mainly takes place in data reception, data transmission and data processing. Energy consumption in data transmission is much higher as compared to the data reception and data processing. Data aggregation is one of the most suitable and trending techniques to overcome the energy consumption in data transmission. Data aggregation reduces energy consumption in WSNs. In the WSNs there are exist heavy traffic, collision, attack, and processing delay that's why achieving the ideal accuracy are complicated. Collection of accurate information and aggregation in wireless sensor network are also issues, basically, two issues data privacy and accuracy comes into the picture. A new approach to overcome these issues has called REBIVE. REBIVE approach includes privacy protection and accuracy maintenance. Wireless sensor networks have so many applications among these applications target tracking and habitat monitoring. In wireless sensor networks, the sensor node may fail then data confidentiality and data integrity type's issues come. The secure data aggregation scheme categorized into two categories, one aggregator model and multiple aggregator model. Data collection and energy efficiency point of view tree-based data aggregation scheme is more efficient as compared to all other exiting schemes. In a tree-based data aggregation scheme, when a node fails then communication breaks in the network even there exists a path among the network. Node may fails due to hardware and energy loss.

This chapter presents a novel approach for data aggregation called a power level based DA. The node for data aggregator is selected based on the power level of nodes. The proposed approach has compared with the existing approaches tree-based DA, cluster-based DA, chain based DA and grid-based DA.

### 3.2 Data Aggregation Techniques

There are four data aggregation techniques have considered in the literature. The proposed approach is power level based data aggregation (PLBDA).

1. Tree-Based Data Aggregation
2. Cluster-Based Data Aggregation
3. Chain Based Data Aggregation
4. Grid-Based Data Aggregation

#### 3.2.1 Tree-Based Data Aggregation

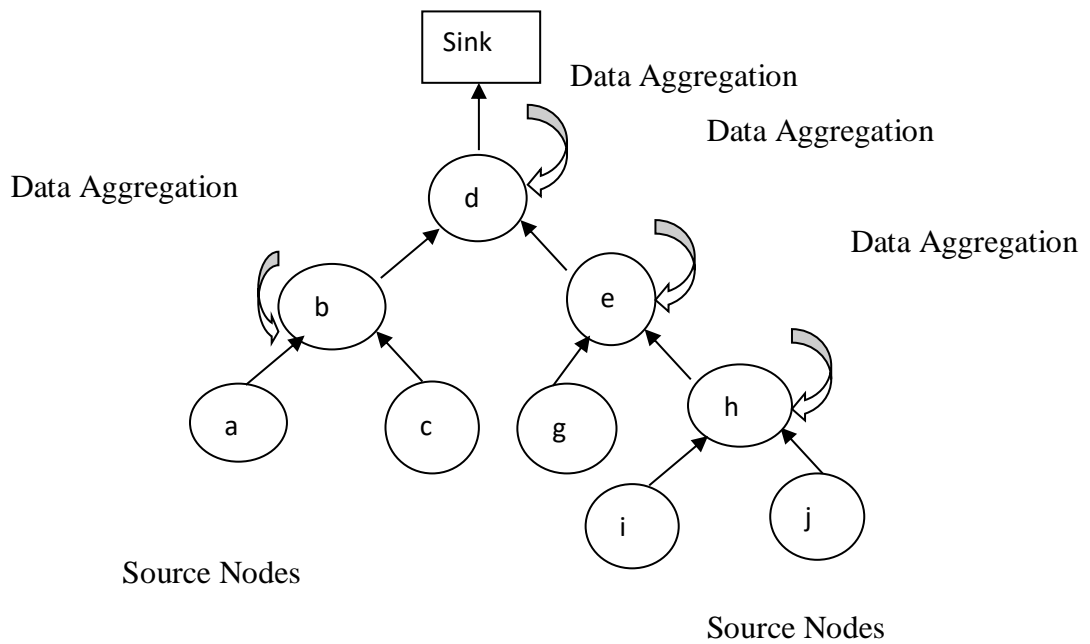

**Figure 3.1** Tree Construction for DA

$$b = f(a, c) \tag{3.1}$$

$$h = f(i, j) \tag{3.2}$$

$$e = f(g, h) \tag{3.3}$$

$$d = f(b, e) \tag{3.4}$$

Figure 3.1 shows the tree-based data aggregation. Where non leaf nodes work as data aggregator nodes. R bit data transmission cost is given as

$$A_{lm}(R) = 2 \times E_{elec} \times R + E_{amp} \times R \times b_{lm}^2 \quad (3.5)$$

Where  $A_{lm}(R)$  is the cost of R bit data transition from node l to node m,  $b_{lm}$  is the distance between node l to node m.  $E_{elec}$  is the energy expenditure in switch and reception,  $E_{amp}$  is the energy of the broadcast amplifier.

### 3.2.2 Cluster-Based Data Aggregation

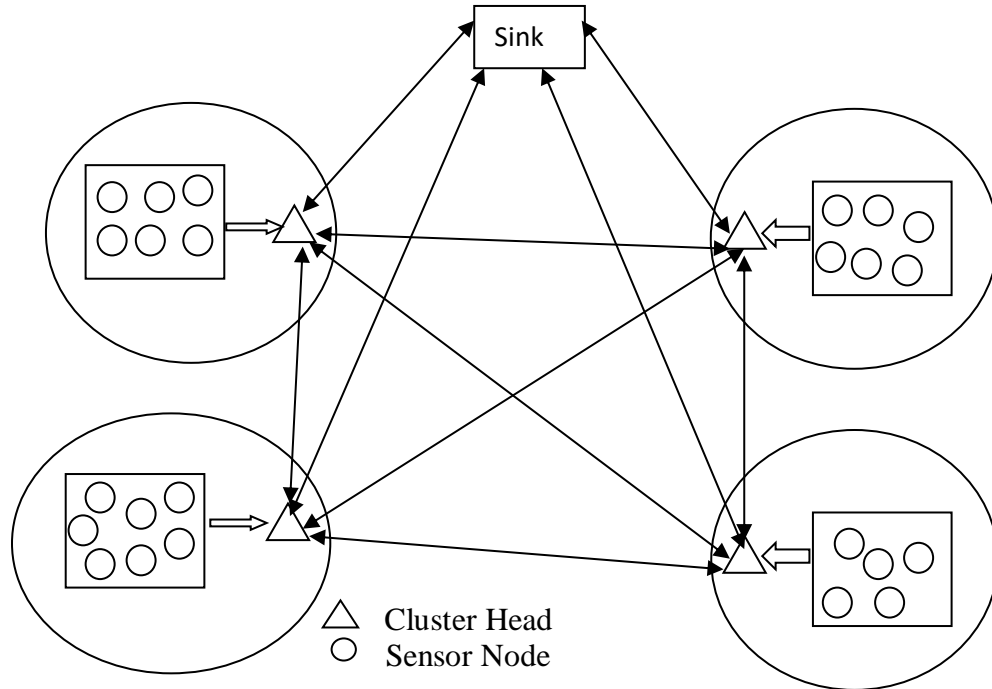

**Figure 3.2** Cluster Construction for DA

Figure 3.2 shows the cluster construction for the DA. LEACH is one of the most popular cluster-based data aggregation approaches. LEACH protocol has two stages first one is set up phase and the second one is a steady phase.

$$\beta_l = \frac{g}{1 - g(k \bmod (1/g))} \quad (3.6)$$

Where  $\beta_l$  is the doorstep cost for a node to turn into bunch leader, mod is the modulus operator, k is the const value lies between 0 to 1, g is the fraction value to elect bunch leader among them nodes.

### 3.2.3 Chain Based Data Aggregation

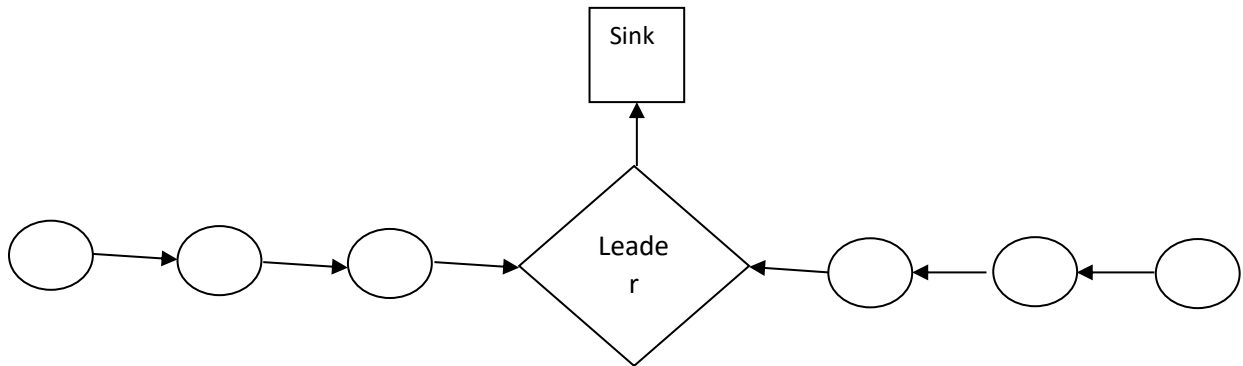

Figure 3.3 Chain Construction for DA

Figure 3.3 shows the chain based data aggregation. PEGASIS is one of the most popular techniques of the chain-based approach. Cluster-based DA is not suitable when the sink node is far from the clusters.

### 3.2.4 Grid-Based Data Aggregation

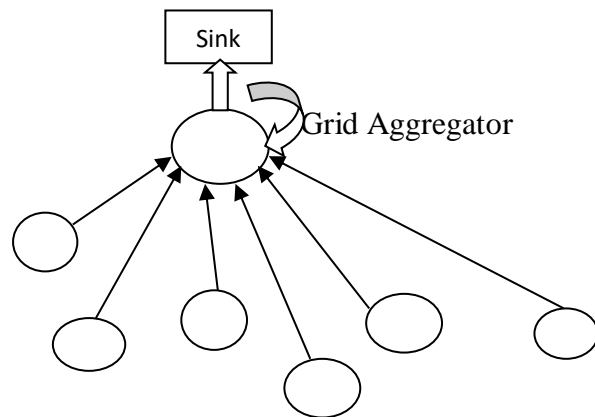
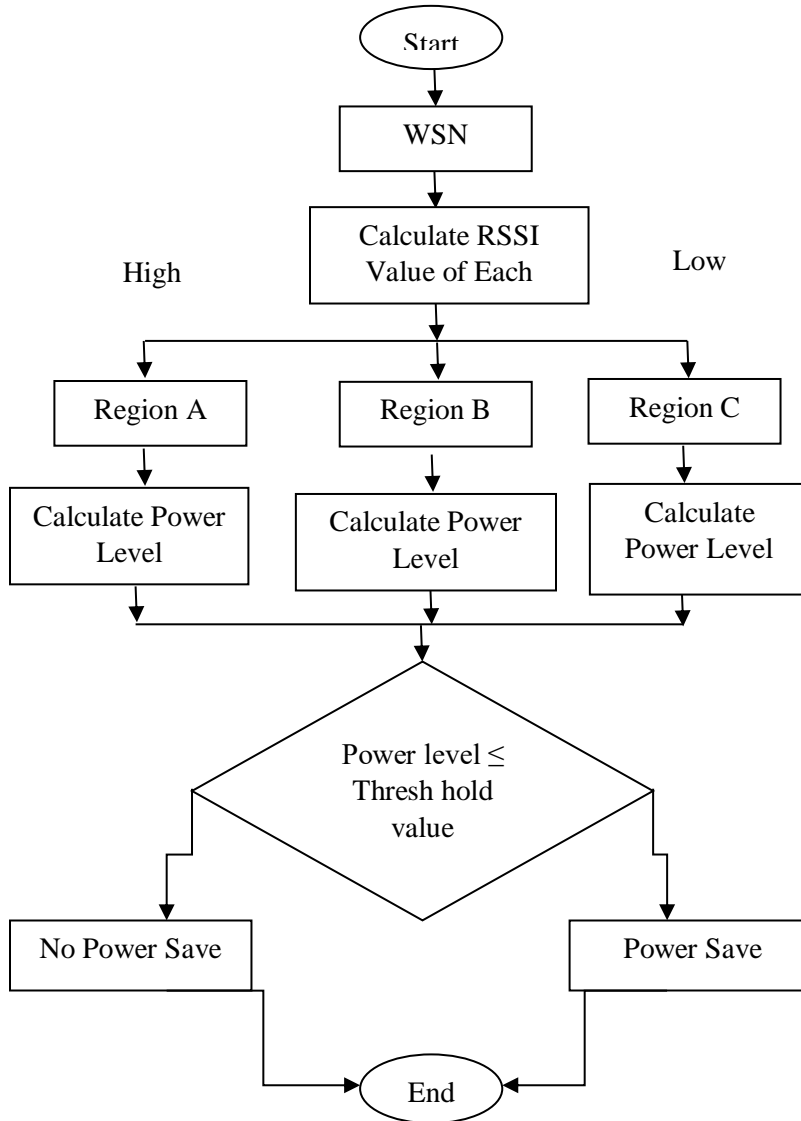

Figure 3.4 Grid-Based Construction for DA

Figure 3.4 shows the grid-based data aggregation. Each and every sensor nodes transfer the data to the grid aggregator node and the grid aggregator node transfers the data to the sink node. Grid-based data aggregation is more appropriate for the mobile sink node. Grid-based data aggregation approach is capable to improve the end to end response time.

### 3.3 Proposed Model

A proposed model has drawn in this section. Model show how to node categorized into different categories. There are three regions. Region A has nodes those have higher RSSI values. Region C has nodes those have lesser RSSI values.



**Figure 3.5** Flow Chart of Proposed Model

Figure 3.5 shows the flow chart of the proposed model. Nodes are categorized into three regions based on RSSI value. Nodes that have high RSSI value come under region A, those have low RSSI value comes under region C and those have medium RSSI value comes under region B.



### 3.3.1 Proposed algorithm PLBDA

RSSI	Radio Signal Strength Indication
$RSSI_l(A)$	Radio Signal Strength Indication node A
$RSSI_l(Th)$	Radio Signal Strength Indication value for the threshold
$N_c$	Current Power level
$N_d$	Desired Power level
$RSSI_l(N)$	New Radio Signal Strength Indication
$Power_s$	Power Save

1. if  $RSSI_l(A) \geq RSSI_l(Th)$
2. then
3. if  $N_c \geq N_d$
4. then
5.  $RSSI_l(N) = RSSI_l(Th)$
6. *else*
7.  $RSSI_l(A) = RSSI_l(N)$
8. *endif*
9. *endif*
10. if  $RSSI_l(A) < RSSI_l(Th)$
11. *then*
12.  $RSSI_l(N) = RSSI_l(A)$
13. *endif*
14.  $Power_s(A) = Power_{level} - Power_{level}(N)(A)$

### 3.3.2 Simulation Scenario

The proposed approach is implemented with the parameters of table 3.1.along with additional system hardware are core i5, windows 7 64 bit, 4 GB Ram, 2.1 GHz processor. Same parameters have taken for cluster-based data aggregation, chain based data aggregation, tree-based data aggregation, and grid-based data aggregation.

**Table 3.1** Simulation Parameters

S. No.	Parameter	Value
1	Nodes	100 and 500
2	Network Area	100 M *100 M, 1000 M * 1000 M
3	Software	Matlab
4	DA Energy	5 Nano Joule
5	Position of Sink Node	Dynamic
6	Initial Energy of Nodes	.1 Joule

### 3.3.3 Analysis on Results

The results analyses are presented by this section. Graphs are showing a better visualization of the results. Figure 3.6 to figure 3.14 show the analysis of the results for the proposed approach and has compared with the existing approaches tree-based data aggregation, cluster-based data aggregation, chain based data aggregation and grid-based data aggregation. Two scenarios have considered in this section, the first one scenario with 100 nodes and the second one scenario is with 500 nodes.

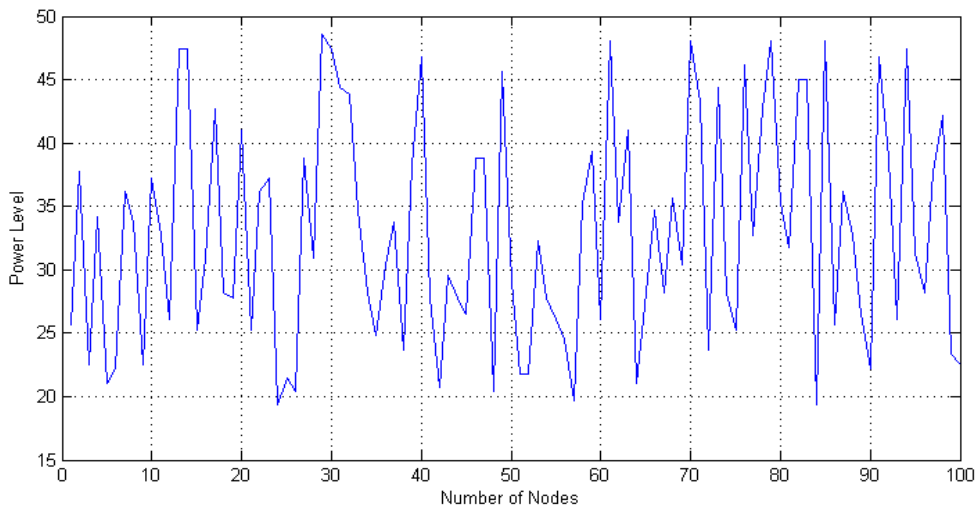

**Figure 3.6** Power Levels of Nodes

Figure 3.6 shows the level of power for nodes. The X-axis represents the nodes, y-axis represents the level of power (dBm). Each node has a different level of power.

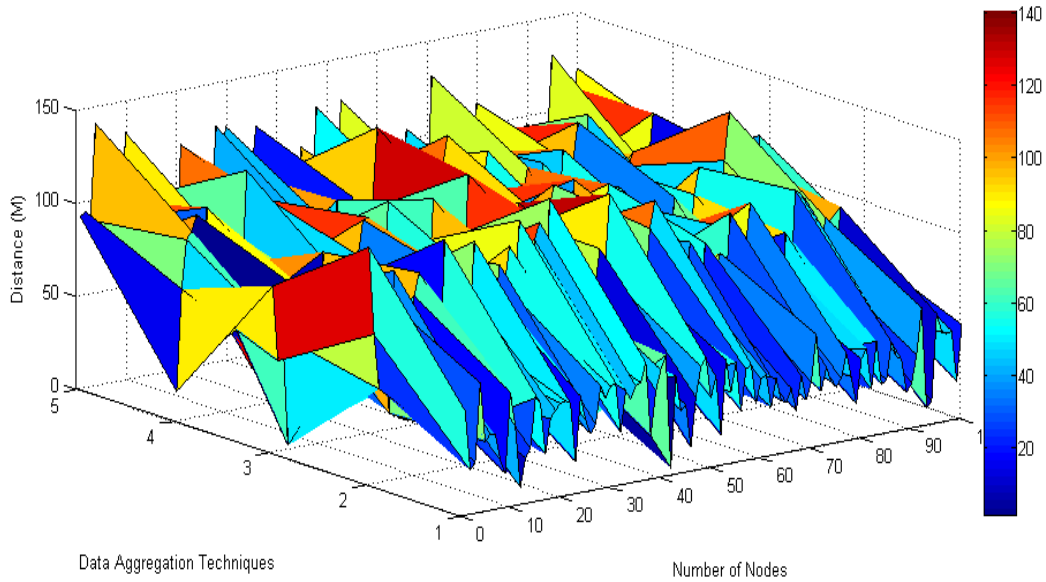

**Figure 3.7** Node Distance from Sink Node

Figure 3.7 shows the node distance from the sink node. The X-axis represents the number of nodes, the y-axis represents the DA techniques and the z-axis represents the distance.

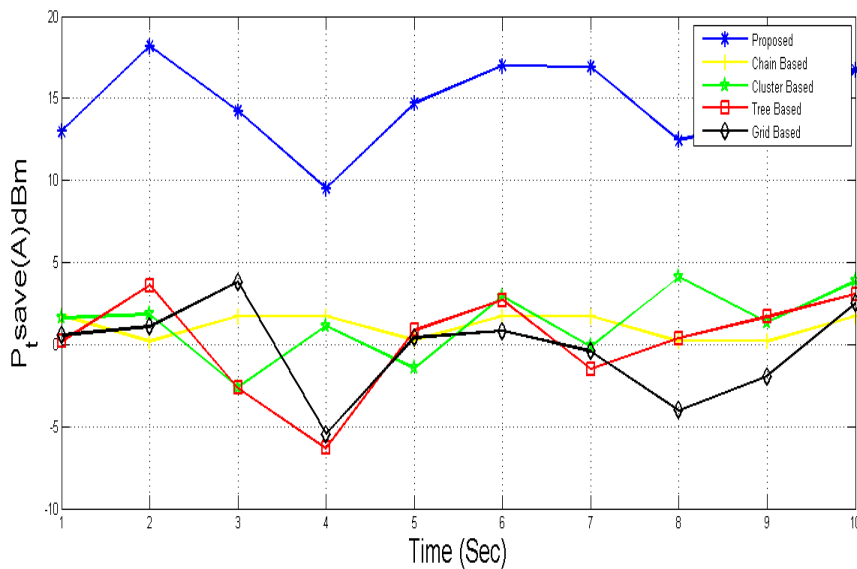

Tree Based [90]  
 Cluster Based [91]  
 Chain Based [92]  
 Grid Based [93]

**Figure 3.8** Save Power for situation A (100 Nodes)

Figure 3.8 shows the transmission power saves for 100 nodes in region A. X-axis represents the time in seconds, y-axis represents the power level in dBm. The proposed approach saves more power transmission as compared to the cluster-based, chain based, tree-based and grid-based approaches.

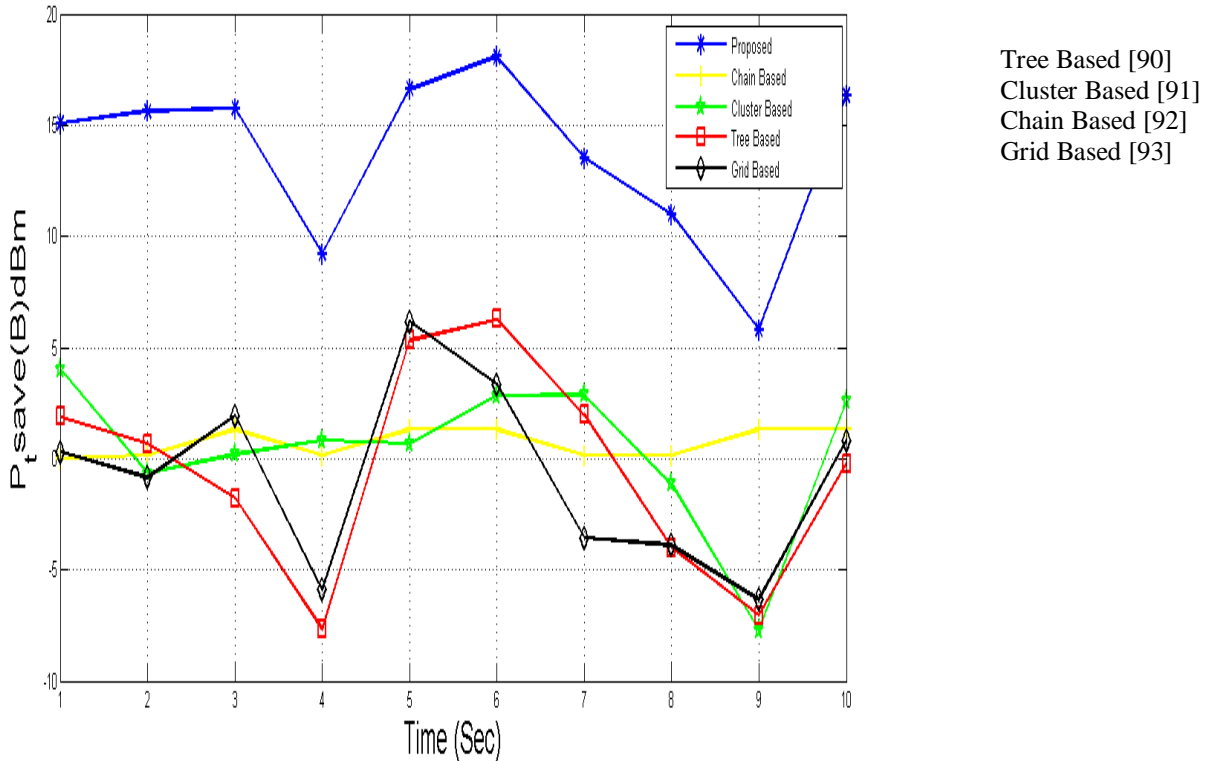

**Figure 3.9** Save Power for situation B (100 Nodes)

Figure 3.9 shows the power transmission saves for 100 nodes region B. X-axis represents the time in seconds, y-axis represents the power level in dBm. The proposed approach saves more power transmission as compared to the cluster-based, chain based, tree-based and grid-based approaches.

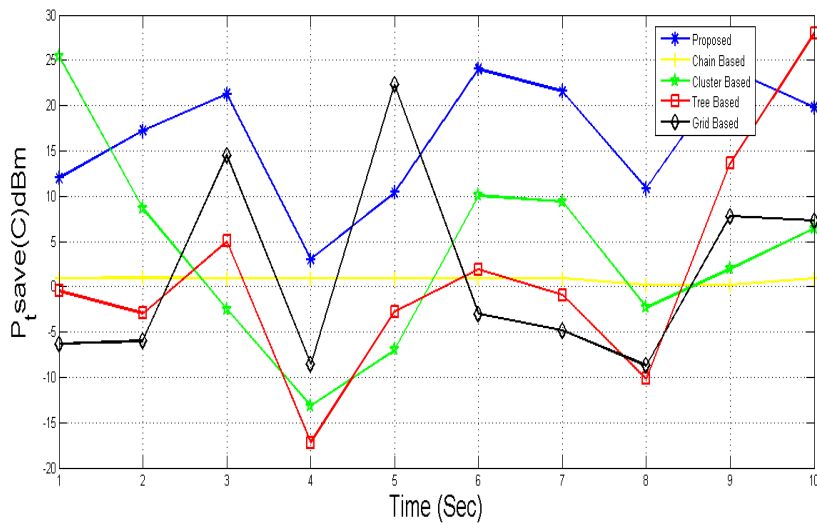

Tree Based [90]  
 Cluster Based [91]  
 Chain Based [92]  
 Grid Based [93]

**Figure 3.10** Save Power for situation C (100 Nodes)

Figure 3.10 shows the power transmission saves for 100 nodes region C. X-axis represents the time in seconds, y-axis represents the power level in dBm. The proposed approach saves more power transmission as compared to the cluster-based, chain based, tree-based and grid-based approaches. Meanwhile, the simulation has been observed that the cluster-based approach and grid-based approach is better as a comparison to the proposed approach but on average after the complete simulation proposed approach is better as a comparison to the existing approaches.

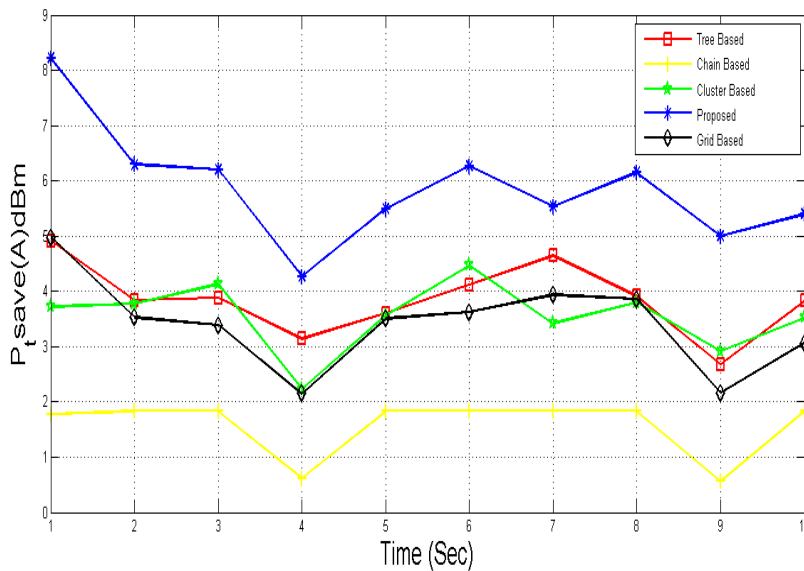

Tree Based [90]  
 Cluster Based [91]  
 Chain Based [92]  
 Grid Based [93]

**Figure 3.11** Save Power for situation A (500 Nodes)

Figure 3.11 shows the power transmission save for 500 nodes region A. X-axis represents the time in seconds, y-axis represents the power level in dBm. The proposed approach saves more power transmission as compared to the cluster-based, chain based, tree-based and grid-based approaches.

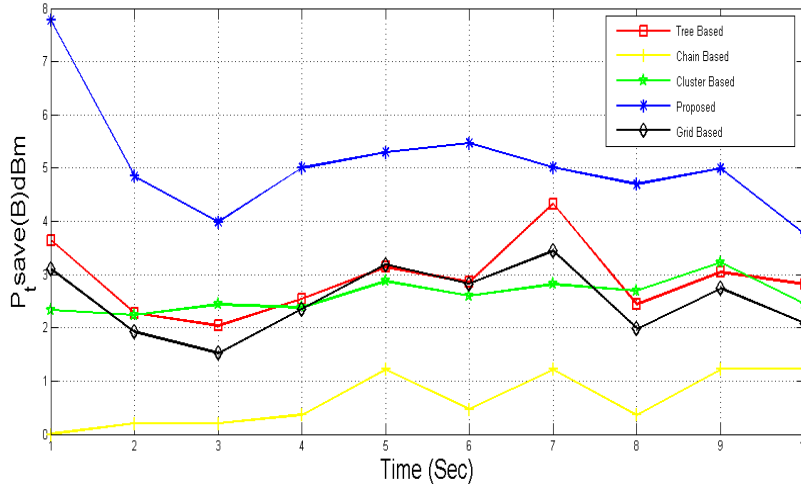

Tree Based [90]  
 Cluster Based [91]  
 Chain Based [92]  
 Grid Based [93]

Figure 3.12 Power Save for situation B (500 Nodes)

Figure 3.12 shows the transmission power saves for 500 nodes region B. X-axis represents the time in seconds, y-axis represents the power level in dBm. The proposed approach saves more power transmission as compared to the cluster-based, chain based, tree-based and grid-based approaches.

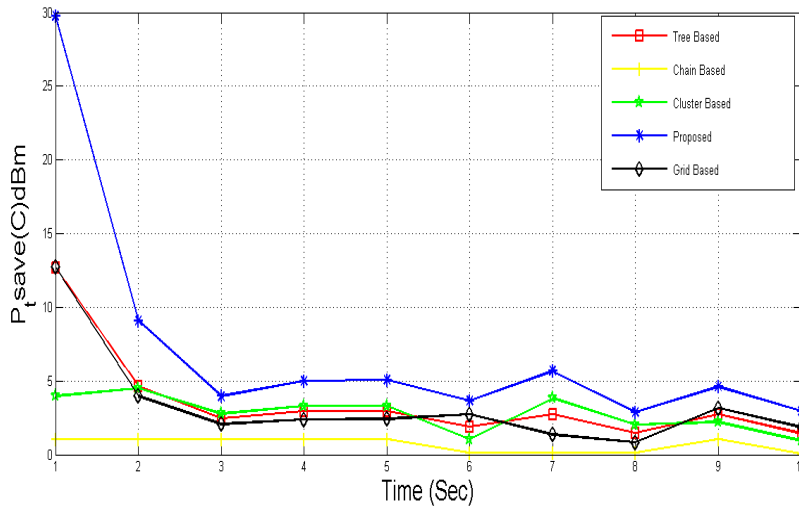

Tree Based [90]  
 Cluster Based [91]  
 Chain Based [92]  
 Grid Based [93]

Figure 3.13 Save Power for situation C (500 Nodes)

Figure 3.13 shows the transmission power saves for 500 nodes region C. X-axis represents the time in seconds, the y-axis represents the power level in dBm. The proposed approach saves more power transmission as compared to the cluster-based, chain based, tree-based and grid-based approaches.

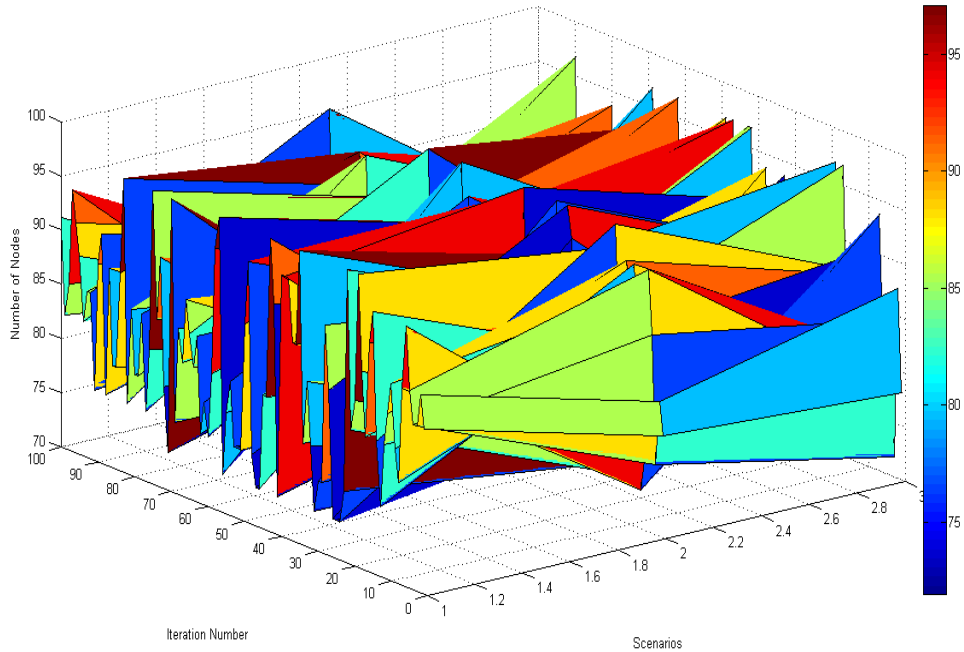

**Figure 3.14** Number of Nodes situation Wise

Figure 3.14 shows the number of nodes with scenario wise. The X-axis represents the number of scenarios, y-axis represents the number of iteration and the z-axis represents the number of nodes. The high power values region has fewer nodes and the low power vales region has a large number of nodes.

Table 3.2 illustrates the power transmission save with two scenarios (100 nodes and 500 nodes). Situation A, situation B, and situation C are the regions for high RSSI value of nodes, medium RSSI values of the nodes and low RSSI value of nodes respectively. The proposed approach is power level based data aggregation. Table 3.2 clearly shows that proposed save more power transmission as compare to the cluster-based data aggregation, chain based data aggregation, grid-based data aggregation, and tree-based data aggregation.

**Table 3.2** Power Transmission Save (dBm)

<b>Network Size</b>	<b>100 Nodes</b>			<b>500 Nodes</b>		
<b>Algorithms</b>	situation A	situation B	situation C	situation A	situation B	situation C
<b>Proposed PLBDA</b>	16.5	15.15	20.13	5.23	3.85	5.71
<b>Tree Based Data Aggregation[90]</b>	4.1	0.91	26.43	3.92	2.96	4.23
<b>Cluster Based Data Aggregation[91]</b>	4.8	2.75	7.8	3.87	2.55	3.21
<b>Chain Based Data Aggregation[92]</b>	2.9	2.15	2.1	1.98	1.23	1.12
<b>Grid Based Data Aggregation[93]</b>	3.5	1.95	8.1	3.0	2.04	2.5

### 3.4 Summary

Power of the node is spent in three ways transmission the data, reception the data and processing the data. Most of the power consumed in the transmission of the data. In this work, mainly focused on save the power which consumes in the data transmission. Results section clearly shows that proposed approach power level based data aggregation (PLBDA) is better as compared to the existing approaches like tree-based DA, cluster-based DA, chain based DA and grid-based DA. In the future, power level based DA may be used to improve the network lifetime and network throughput.



## CHAPTER 4

# NETWORK THROUGHPUT AND LIFETIME OF NETWORK IN WSN

### 4.1 Introduction

There are a number of issues in WSNs like energy consumption, communication, specific destination, periodic & event detection, synchronization, scalability, etc. energy consumption is one of the major issues in wireless sensor networks. Energy consumption directly reflects the network's lifetime. Generally, the network lifetime depends on the first node dead. The wireless sensor network is used in many applications like healthcare, agriculture, military, environment monitoring, wildlife monitoring, etc. There are some constraints in wireless sensor networks like energy consumption, network lifetime, network throughput, etc. To overcome these issues, data aggregation is one of the most suitable techniques. Data aggregation is performed in two ways MSDU and MPDU. Accuracy is also important in data aggregation. In wireless sensor networks data aggregation can be done in two ways first one is event-triggered (queries based) and the second one is periodic data gathering (monitoring the habitat). Data aggregation is also done two levels. Two-level data aggregation is done in a periodic manner. Sensor nodes that are near to the base station are dead early as compare to the sensor nodes are those that are far from the base station in wireless sensor networks when data aggregation techniques are applied. There are two ways to resolve this problem, structured and non-structured network design. Structured based architecture is suitable for energy utilization as compared to unstructured architecture. As the size of the network increases some more challenges are came to the picture. Mobile sensor nodes are more suitable in that scenario. Mobile sensor nodes are more suitable for tracing the events. Static nodes are more suitable for the cases where information needs to be sent back to the base station. Most of the energy consumption takes place in transmitting the data as compared to the receiving and processing of the data. In-network data aggregation architecture has been designed in tree structure way to reduce the energy consumption in transmission. Data aggregation tree construction in two ways first one is centralized and the second one is a distributed manner. Generally, sensor nodes are not rechargeable but now a day some techniques has came to the

research by which sensor nodes are recharged like solar energy, body heat and foot strike, etc. Rechargeable sensor nodes have some own limitations and constraints. The storage capacity of sensor nodes decreases. In this chapter, a novel approach (hybrid approach) is discussed and has compared with existing approaches LEACH and SEP approach.

### 4.2 Proposed Model

The proposed model is based on a hybrid approach that is combination of direct transmission and transmission through cluster head. The below figure shows the proposed model.

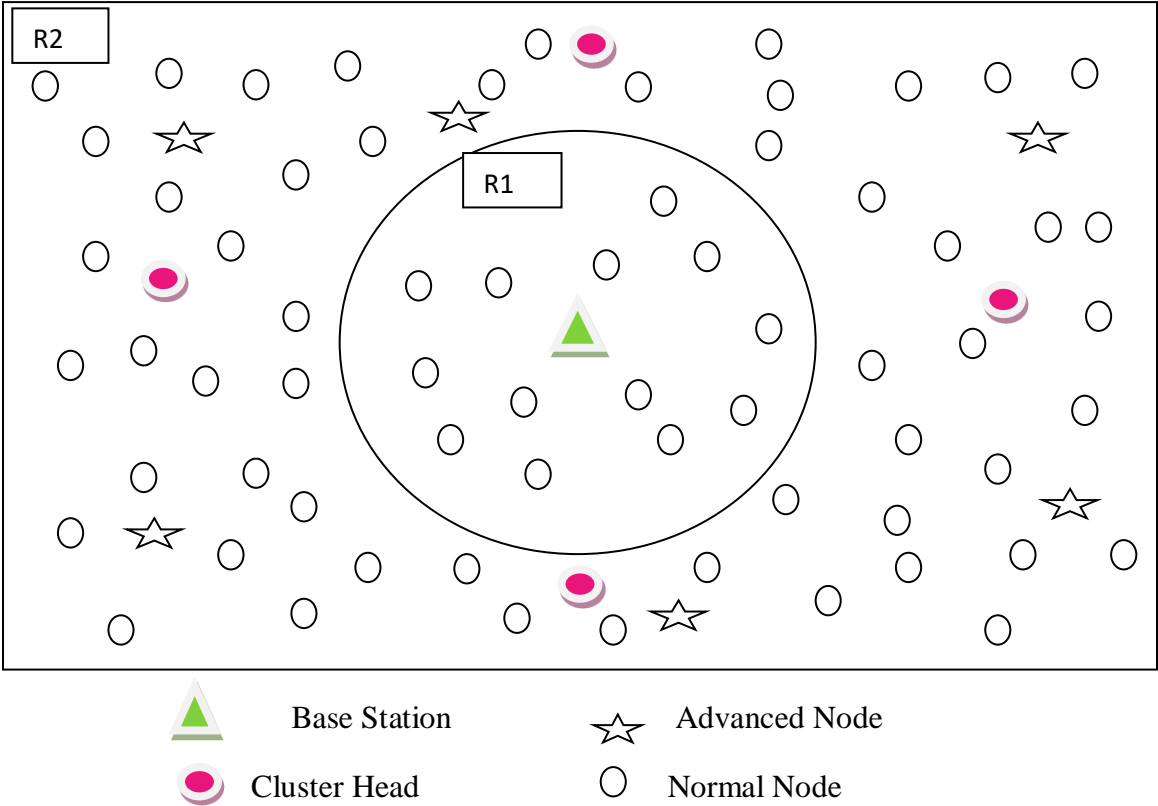

Figure 4.1 Proposed Network Model

Figure 4.1 represents the proposed network model. The network is divided into two regions R1 and R2. Nodes directly transmit the data to the base station which are under the region R1 and nodes those are in region R2 transmits the data to the cluster head and then cluster head aggregates the data then transfer to the base station.

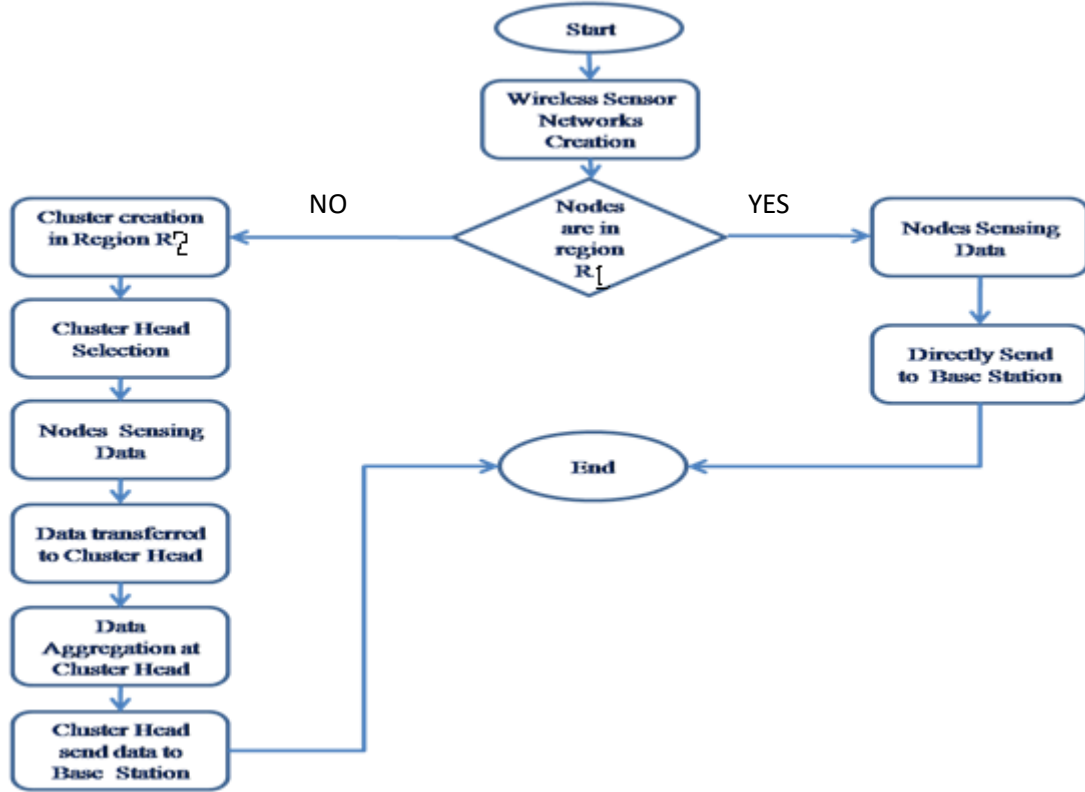

Figure 4.2 Flow Chart of Proposed Model

Figure 4.2 represents the flow chart of the proposed model. At the first place, WSN creation takes place then checks for the region of the nodes. If nodes are region R1 then nodes directly data transfer to the base station. Otherwise, cluster formation takes place in region R2, then cluster head selection take places. Nodes transmit the data to the cluster head and then cluster head transfer the data to the base station

Cluster head selection is based on the equation 1.

$$T(n) = \begin{cases} \frac{P}{1 - P * \left(r \bmod \frac{1}{P}\right)} & \text{if } n \in G \\ 0 & \text{otherwise} \end{cases} \quad (4.1)$$

Where p is the probability to be selected as cluster head, r is the round number.

Energy consumption is calculated with the help of equations 2, 3 and 4. Energy consumption in data transmission is calculated with equation 2 and energy consumption in data reception is calculated with equation 4.

---

**Algorithm4.1** Proposed AlgorithmFor Data Transmission

---

Input: Network with n number of nodes

Output: Data at the base station

1. Create a sensor network with n nodes.
2. for i=1 to n
3.     if (n.region==R1)
4.         sensed the data
5.         data send to the sink node
6.     else
7.         cluster formation
8.         CH selection (region R2)
9.         sensed the data
10.        data send to cluster head
11.        apply DA at CH
12.        data send to base station
13.     end else
14.     end if
15. end for

$$E_{Tx}(I, d) = E_{Tx-ele}(I) + E_{Tx-amp}(I, d) \quad (4.2)$$

$$E_{Tx}(I, d) = \begin{cases} I * E_{ele} + I * \varepsilon_{fs} * d^2 & \text{if } d < d_0 \\ I * E_{ele} + I * \varepsilon_{mp} * d^4 & \text{if } d \geq d_0 \end{cases} \quad (4.3)$$

$$E_{Rx}(I) = E_{ele} * I \quad (4.4)$$

$$d_0 = \sqrt{\varepsilon_{fs} / \varepsilon_{mp}} \quad (4.5)$$

Where  $E_{Tx}$  is the energy expenditure in data transmission,  $E_{Rx}$  is the energy consumption in data reception, I is the number of bits, d is the distance between source and sink,  $d_0$  is the thresh hold vale.

---

**Algorithm 4.2** Cluster Head Selection

---

Input: Network with n number of nodes

Output: Cluster head list

1. Objective function  $f(x)$ ,  $x = (x_1, x_2, \dots, x_m)$
2. Generate initial population of sensor nodes  $x_i$  ( $i = 1, 2, \dots, m$ )
3. Node energy  $E_i$  at  $x_i$  is determined by  $f(x_i)$
4. Define energy absorption coefficient  $\alpha$
5. while ( $t < \text{MaxGeneration}$ )
6. for  $p = 1$  to  $m$
7. for  $q = 1$  to  $p$
8. if ( $E_q > E_p$ ), Move cluster head  $p$  towards  $q$
9. end if
10. Cluster head selection varies with distance  $r$  via  $\exp[-\alpha r]$
11. appraise new solutions and bring up to date energy
12. end for  $q$
13. end for  $p$
14. Rank the node and find the current best
15. end while

#### 4.2.1 Simulation Scenario

The proposed approach is implemented with the parameters of table 3.1. along with additional system hardware are core i5, windows 7 64 bit, 4 GB Ram, 2.1 GHz processor. There are same parameters have been taken for the proposed approach, LEACH approach and SEP approach.

Table 4.1 illustrates the number of simulation parameters. There are two scenarios have considered for graph analysis. First one is 30% advanced nodes and the second one is 10% advanced nodes. Table 4.2 and Table 4.3 are maintained for the first node dead and the number of packets reached the base station. Three scenarios have considered for the table analysis, first, one 10% advanced nodes, second one 20% advanced nodes and the third one is 30% advanced nodes.

**Table 4.1** Simulation Parameters

S.No.	Parameter	Value
1	Network Area	100*100 Meter*Meter
2	Number of Nodes	90
3	Position of Sink Node	50,50
4	Percentage of Advanced Nodes	10% to 30%
5	Initial Energy of Advanced Nodes	2* Initial Energy of Normal Nodes
6	Initial Energy of Normal Nodes	.5 Joule
7	Number of Iterations	7000, 8000

### 4.3 Analysis on Results

Graphs show the results analysis. In this chapter two scenarios have considered for the graph analysis and three scenarios considered for table 4.2 and table 4.3. There are 10% advanced nodes (Scenario A) and 30% advanced nodes (Scenario B) for graph analysis, whereas for the table analysis 10% advanced nodes, 20% advanced nodes and 30% advanced nodes taken.

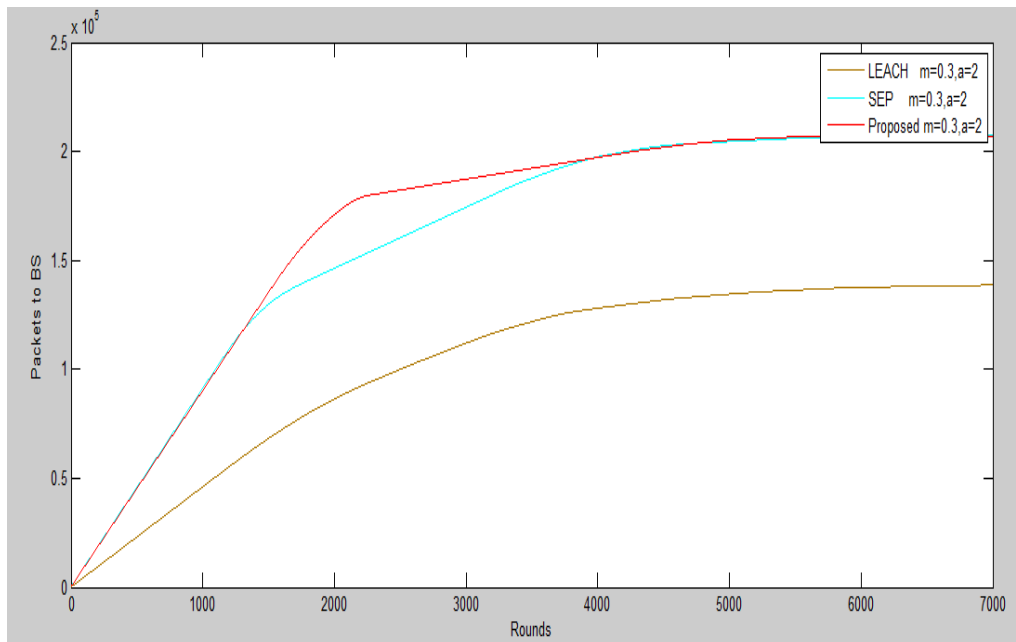

LEACH [42]  
SEP [45]

**Figure 4.3** Network Throughput (A)

Figure 4.3 shows the network throughput for the scenario A. x-axis represents the number of rounds, the y-axis represents the number of packets reached the base station. In this scenario, the proposed approach not much better as compared to the existing approaches.

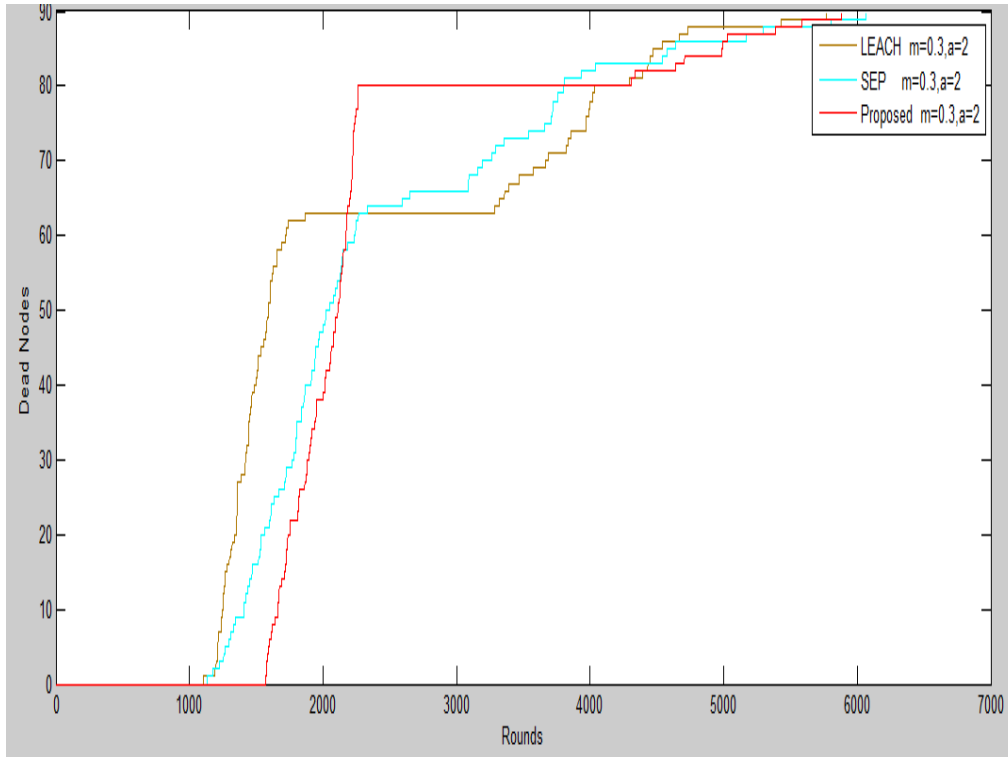

LEACH [42]  
SEP [45]

**Figure 4.4** Dead Nodes (A)

Figure 4.4 shows the dead nodes for scenario A. The x-axis represents the number of iterations, the y-axis shows the number of nodes. Network lifetime depends on the first node dead. The graph clearly shows that the proposed approach has a better network lifetime as compared to the existing approaches (LEACH and SEP).

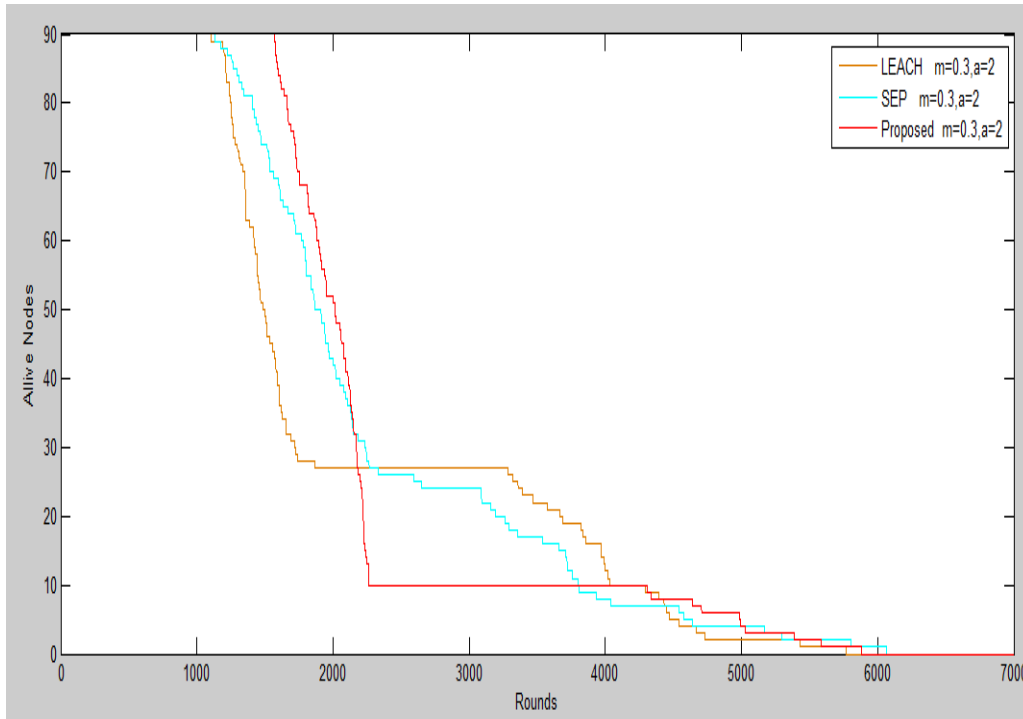

LEACH [42]  
SEP [45]

**Figure 4.5** Alive Nodes (A)

Figure 4.5 shows the alive nodes for scenario A. The x-axis shows the number of rounds, the y-axis shows the number of nodes.

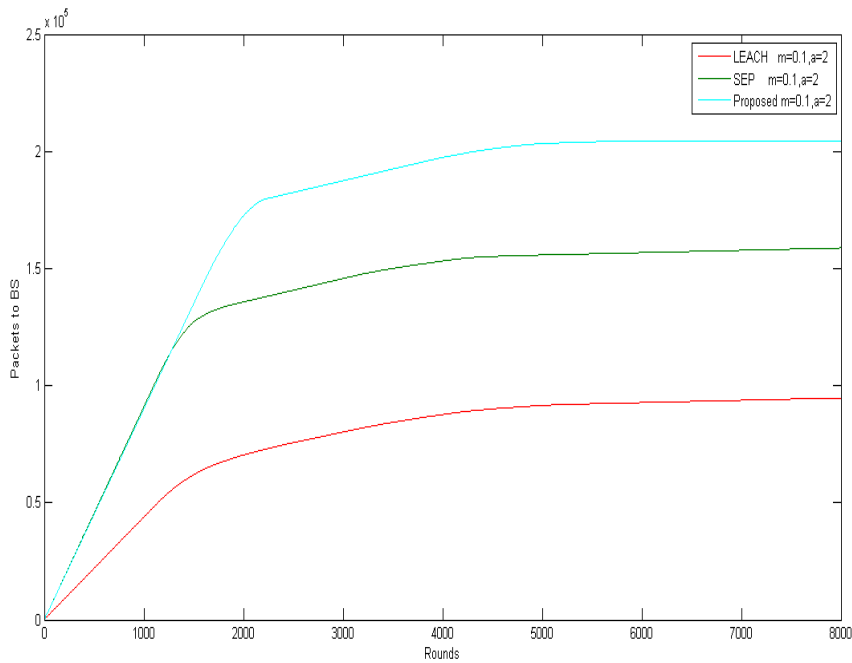

LEACH [42]  
SEP [45]

**Figure 4.6** Network Throughput (B)



Figure 4.6 shows the network throughput for the scenario B. x-axis represents the number of rounds, the y-axis represents the number of packets reached the base station. In this scenario, proposed approach much better as compared to the existing approaches (LEACH and SEP).

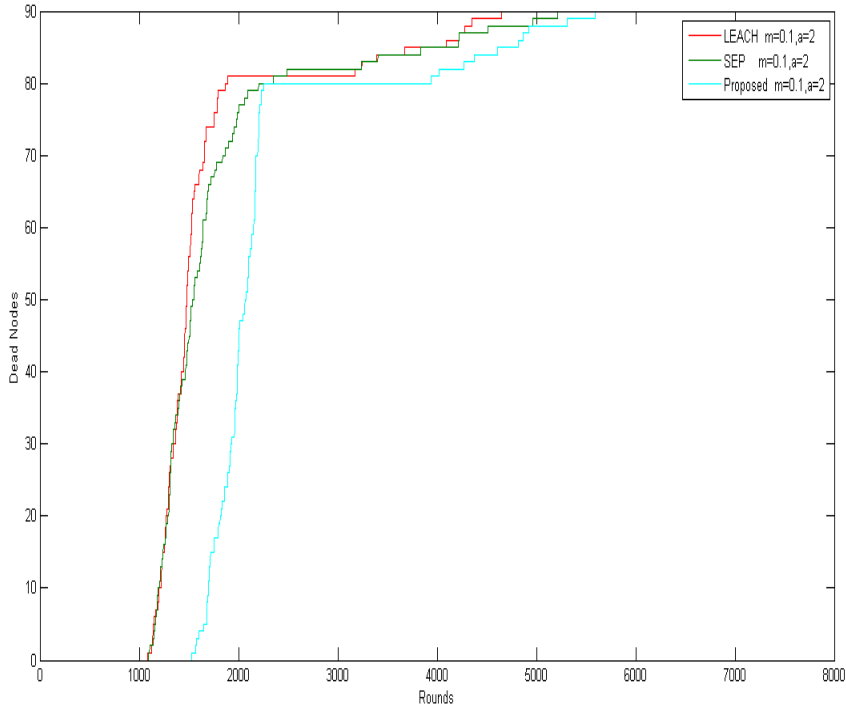

LEACH [42]  
SEP [45]

**Figure 4.7** Dead Nodes (B)

Figure 4.7 shows the dead nodes for scenario B. x-axis shows the number of rounds, the y-axis shows the number of nodes. Network lifetime depends on the first node dead. The graph clearly shows that the proposed approach has a better network lifetime as compared to the existing approaches (LEACH and SEP).

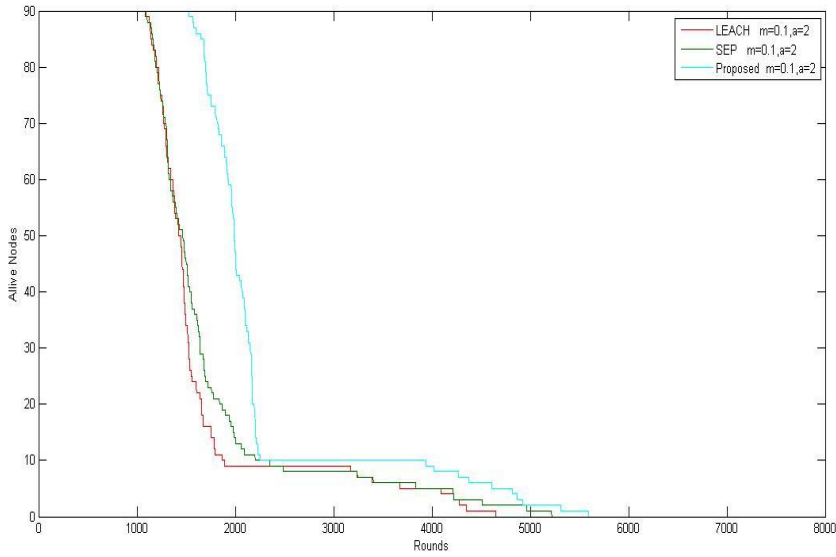

LEACH [42]  
SEP [45]

**Figure 4.8** Alive Nodes (B)

Figure 4.8 shows the alive nodes for scenario B. x-axis shows the number of rounds, the y-axis shows the number of nodes.

The proposed approach is better with 10% advanced nodes throughout the simulation. Table 4.2 shows the network lifetime and Table 4.3 shows the network throughput with three scenarios (10% advanced nodes, 20% advanced nodes and 30% advanced nodes).

**Table 4.2** First Dead Node

<b>Algorithm used</b>	<b>Number of iterations at which the first node get dead with 10% of advanced nodes</b>	<b>Number of iterations at which the first node get dead with 20% of advanced nodes</b>	<b>Number of iterations at which the first node get dead with 30% of advanced nodes</b>
<b>LEACH [42]</b>	1040	1134	1049
<b>SEP [45]</b>	1105	1212	1111
<b>Proposed</b>	1527	1566	1577

Table 4.2 represents the first node dead with 10%, 20% and 30% advanced nodes. The proposed approach is better in terms of first node dead as compare to the LEACH and SEP approaches.

**Table 4.3** Packets Reached at Base Station

<b>Algorithm used</b>	<b>Packets reached base station with 10% of advanced nodes</b>	<b>Packets reached base station with 20% of advanced nodes</b>	<b>Packets reached base station with 30% of advanced nodes</b>
<b>LEACH [42]</b>	92426	104082	139644
<b>SEP [45]</b>	159943	187971	212201
<b>Proposed</b>	213489	207132	208915

Table 4.3 represents the number of packets reached at the base station with 10%, 20 and 30% advanced nodes. The proposed approach is better in terms of the number of packets reached at the base station compared to the LEACH and SEP approaches.

#### **4.4 Summary**

This chapter presents a hybrid approach to improve the network lifetime and network throughput. In this work, on heterogeneous network has been considered. Some nodes are advanced nodes those having little bit more energy as compare to the normal nodes. The proposed approach is compared with LEACH and SEP approaches and has found better in terms of the lifetime of network and network throughput. Two scenarios have been shown by the graphs analysis and three scenarios have been shown by tables. The proposed approach with 10% advanced nodes is much better as compared to the 30% advanced nodes. In the future, the multi-heterogeneity approach may be used for the network lifetime and network throughput improvement.

# **CHAPTER 5**

## **ENERGY CONSUMPTION IN WSN**

### **5.1 Introduction**

Energy consumption is one of the most important issues in WSNs. Network lifetime directly depends on the residual energy of the network. Energy consumption take place mainly in three ways first one is data transmission, the second one is data reception and the third one is data processing. A WSN is the combination of sensor nodes. Sensor nodes having some capabilities like receiving the data, transmitting the data and process the data. Sensor nodes sense the data and send to the base station/sink node. Sensor nodes have a limitation in terms of power. Wireless sensor networks are widely used in many areas like military, traffic surveillance, health care, security monitoring, battlefield, environmental monitoring, machine failure diagnoses, agriculture, transportation and many more. In the results section three performance parameters have considered average energy, the throughput of the network and number of cluster head at a particular iteration. There are a number of communication technologies that are used in communication wireless manner. The most popular technologies are Bluetooth, Wi-Fi, ZigBee, UWB (Ultra-wideband) etc. These communication technologies are responsible for the data transmitting from one node to another node in wireless sensor networks. Out of all these communication technologies UWB is most powerful. Recently UWB is widely used for patient monitoring because it has a higher range of communication. The main property of Bluetooth is that it is able to transmit the data and voice simultaneously. The range of Bluetooth is around 10 meter. In the recent era, Bluetooth is available on a laptop, mobile phone, PDA's headset, etc. Bluetooth uses a 2.4GHz ISM (Industrial Scientific and Medical) band. It supports one to many and one to one connections. The data rate of Bluetooth is approximately 1 Mbps which achieve with the help of time division multiple access. Bluetooth also works in a client-server manner.

This chapter presents an energy-efficient architecture (Two-Tier Architecture). Network architecture is designed on the bases of the RSP values of the nodes. Nodes are categorized into a two-tier. Anyone node come either primary tier or secondary tier. Nodes that have higher RSP values come into primary tier and those have low RSP values come into a secondary tier.

## 5.2 Proposed Model

The proposed model is based on two-tier architecture. First one is the primary tier and second one secondary tier. Each tier has own cluster head nodes and gateway nodes. Nodes categorization is based on RSP values. The proposed model has the following assumptions-

- All nodes are static means after deployment there is no movement of nodes location.
- Nodes are not rechargeable means changing of battery is not permissible.
- Each and every node can communicate in a multi-hop scenario.
- Sink node has no restriction in terms of energy.

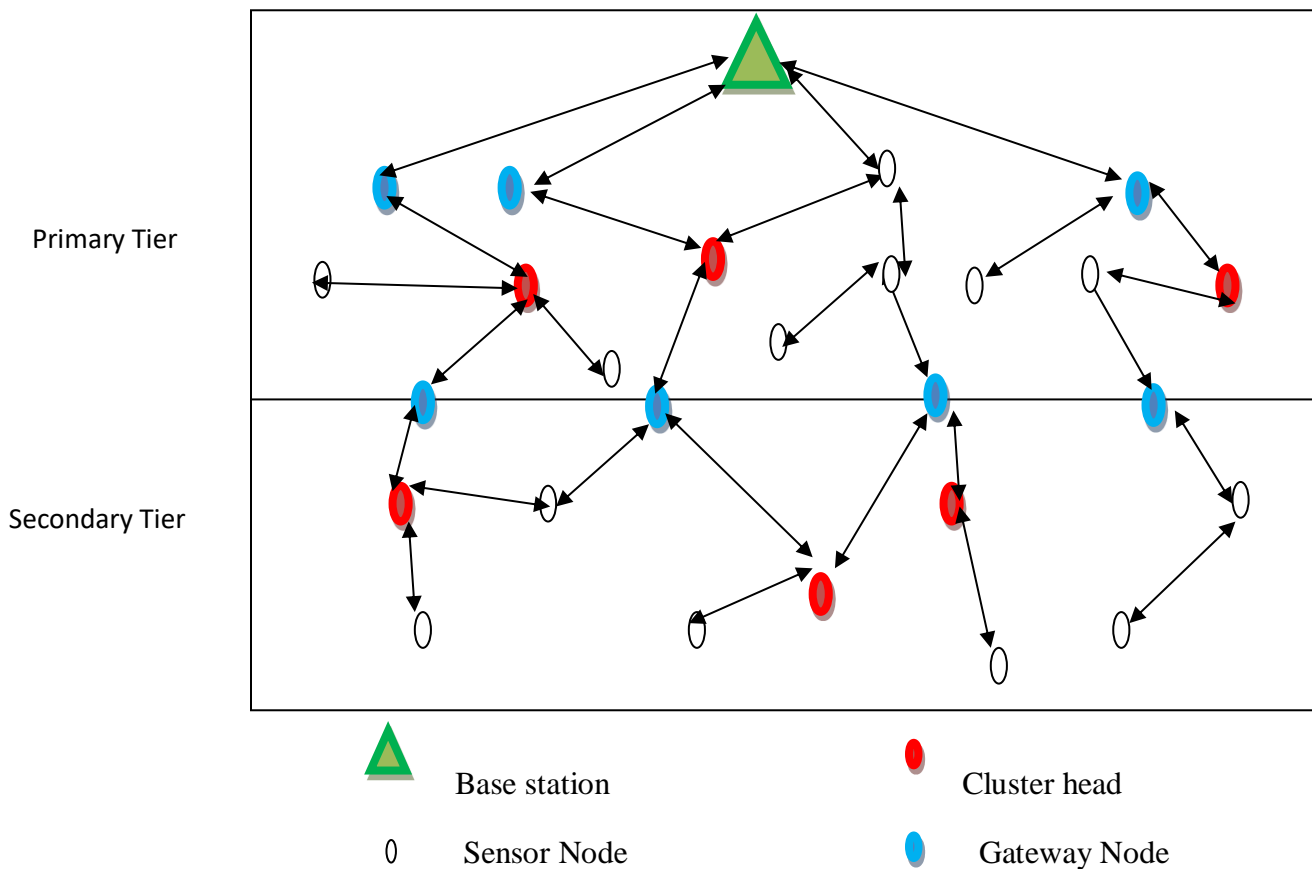

**Figure 5.1** Two-Tier Model for WSN

Figure 5.1 represents the proposed model. The proposed model consists of two-tier, primary tier and secondary tier. The primary tier consists of nodes those having higher RSP values and the secondary tier consists of nodes that having lesser RSP values.

### 5.2.1 Energy Consumption

Received signal power (RSP) values play a vital role in energy consumption analysis. Equation 1 is used to calculate the RSP values. Where  $E_t$  is the random probability,  $E_r$  is the remaining energy of the node,  $E_m$  is the maximum energy of the node.

$$RSP(n) = \left\{ \begin{array}{ll} \frac{E_t}{1 - E_t \left( m \cdot \text{mod} \left( \frac{1}{E_t} \right) \right)} \cdot \frac{E_r}{E_m} & n \in N \\ 0 & \text{otherwise} \end{array} \right\} \quad (5.1)$$

The active time of a node is calculated with equation 2.  $V_m$  is the maximum sense range of the node,  $t - r$  is the coverage of the node.

$$T_n = \frac{t - r}{V_m} \quad (5.2)$$

$$T_f = \min \left\{ \frac{t + r}{V_m}, t_e \right\} \quad (5.3)$$

The sleep time of a node is calculated with equation 3.

$$E_{Tx}(I, d) = \begin{cases} I * E_{ele} + I * \varepsilon_{fs} * d^2 & \text{if } d < d_0 \\ I * E_{ele} + I * \varepsilon_{mp} * d^4 & \text{if } d \geq d_0 \end{cases} \quad (5.4)$$

$$E_{Rx}(I) = E_{ele} * I \quad (5.5)$$

Energy consumption in data broadcast is calculated by equation 4, equation 5 is used to calculate the energy consumption in data reception. Where  $I$  is the number of bits,  $d$  is the distance between the source node and sink node and  $d_0$  is the thresh hold value.

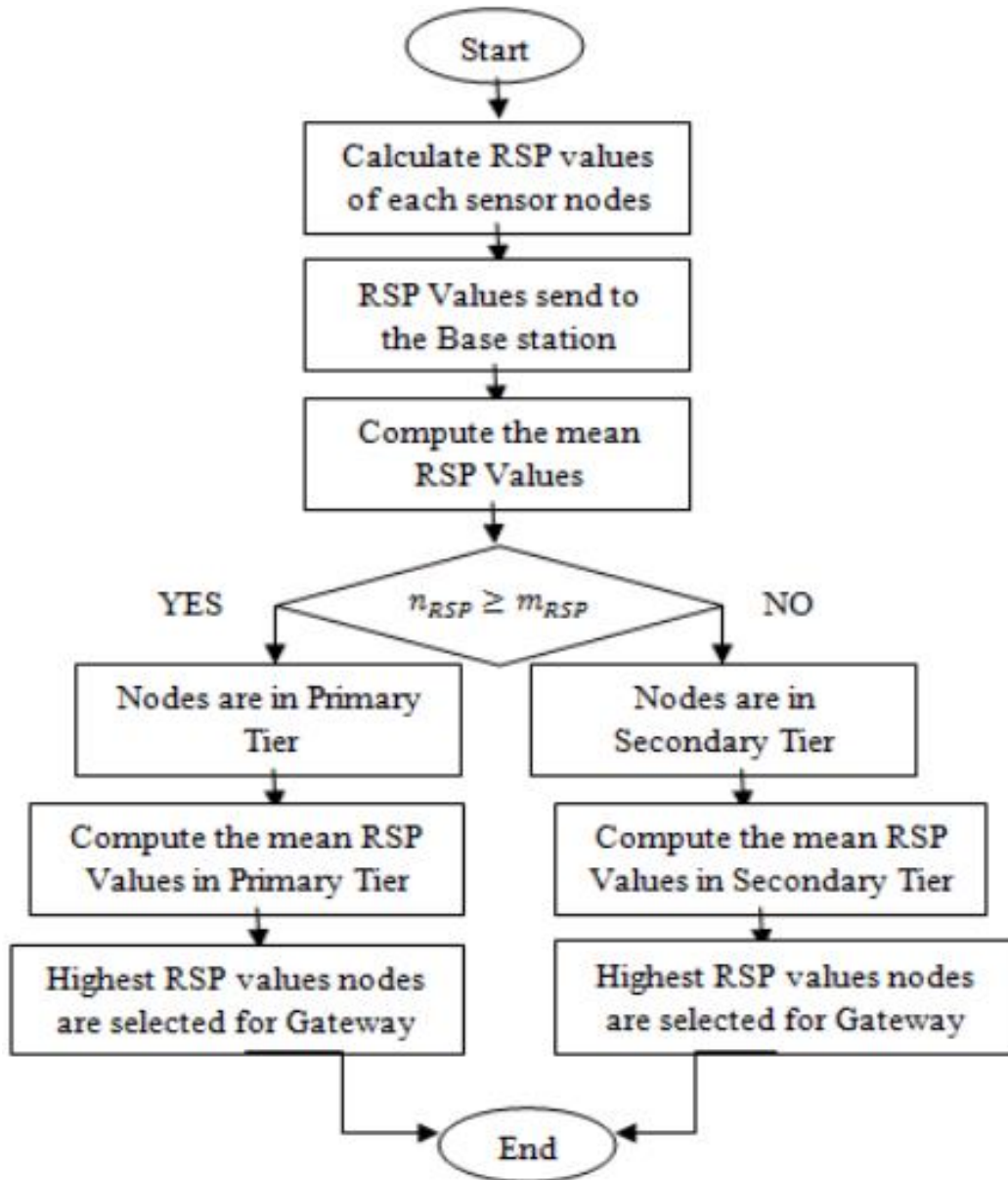

**Figure 5.2** Flow Chart of Proposed Model

Figure 5.2 represents the flow chart of the proposed model. The proposed model is based on the received signal power. RSP value is calculated with the help of equation number 1. Nodes are categorized into two tiers. Nodes those are higher value of RSP as comparison of mean RSP values are comes into the primary tier. Nodes those are a lesser value of RSP as comparison of mean RSP values are comes into the secondary tier.

## 5.2.2 Proposed Algorithm

N is the no. of nodes

RSP(v) is the received signal power value

RSP(p) is the RSP value in the primary tier

RSP(s) is the RSP value in the secondary tier

RSP(m) is the mean RSP value

```
1   for (i=1 to N)
2   RSP (i) ← RSP (v)
3   end for
4   RSP(m) ← RSP(N)/N
5   if (RSP(i)>RSP(m))
6   Primary tier ← ith node
7   else
8   Secondary tier ← ith node
9   Compute the highest value of RSP(p)
10  Gateway node (p) ← highest value of RSP(p)
11  Compute the highest value of RSP(s)
12  Gateway node (s) ← highest value of RSP(s)
```

## 5.3 Experimental Results

The energy of the network, throughput of the network and number of CH in the network at particular iteration mainly analyzed in this chapter. The proposed approach has compared with existing approaches like LEACH and SEP in terms of average energy of the network, throughput of the network and number of cluster head in the network at any particular iteration.

### 5.3.1 Simulation Scenario

Table 5.1 shows the numbers of parameters have taken to implement the proposed approach with existing approaches. Along with additional system hardware are core i5, windows 7 64 bit, 4 GB Ram, 2.1 GHz processor.

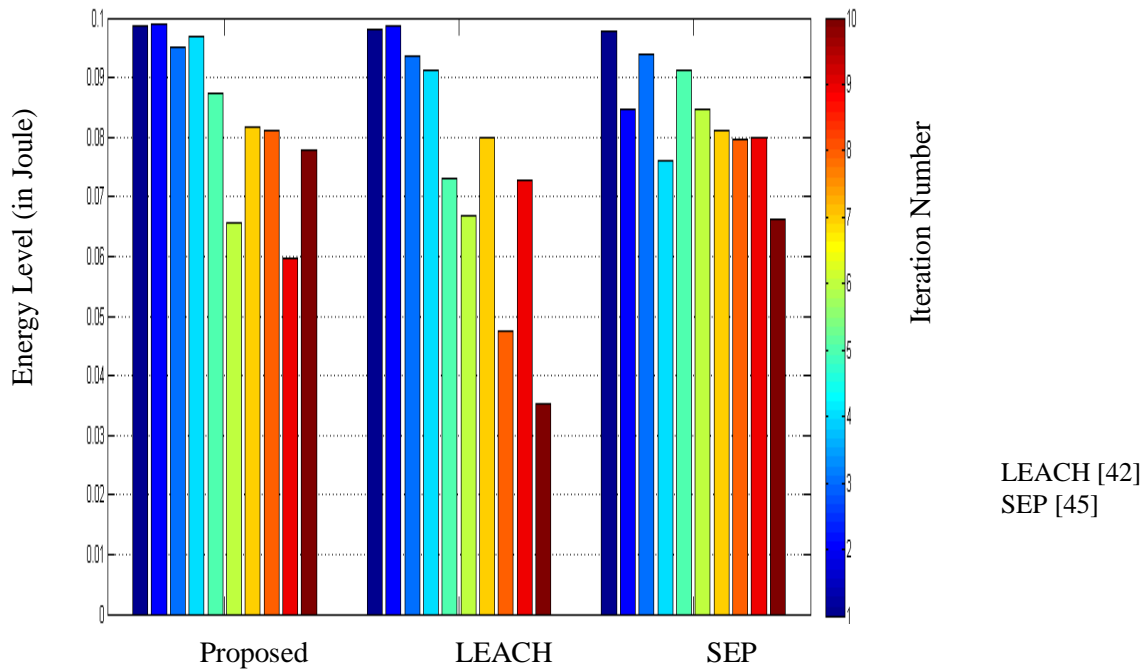

**Table 5.1** Simulation Parameters

S. No.	Parameter	Value
1	Nodes	200
2	Area	100 M * 100 M
3	Position of Sink Node	Center of the Network
4	Initial Energy of Nodes	.1 Joule
5	DA Energy	5 nano Joule
6	Number of Iterations	10,20,50,100

### 5.3.2 Analysis on Results

Energy consumption has analyzed and compared with existing approaches. 2D and 3D graphs are drawn for better interpretation of the results. Two scenarios have considered, in the first scenario energy consumption analyzed for 10 iterations and in second scenario energy consumption for 20 iterations.



**Figure 5.3** Average Energy for 10 Iteration

Figure 5.3 shows the average energy of the network. The X-axis represents the number of iterations with approaches and y-axis represents the energy level in joule. At the starting simulation, each approach has the same energy but after simulation (10<sup>th</sup> iteration) each approach has a different energy level. The proposed approach has a higher energy level as compared to the existing approaches.

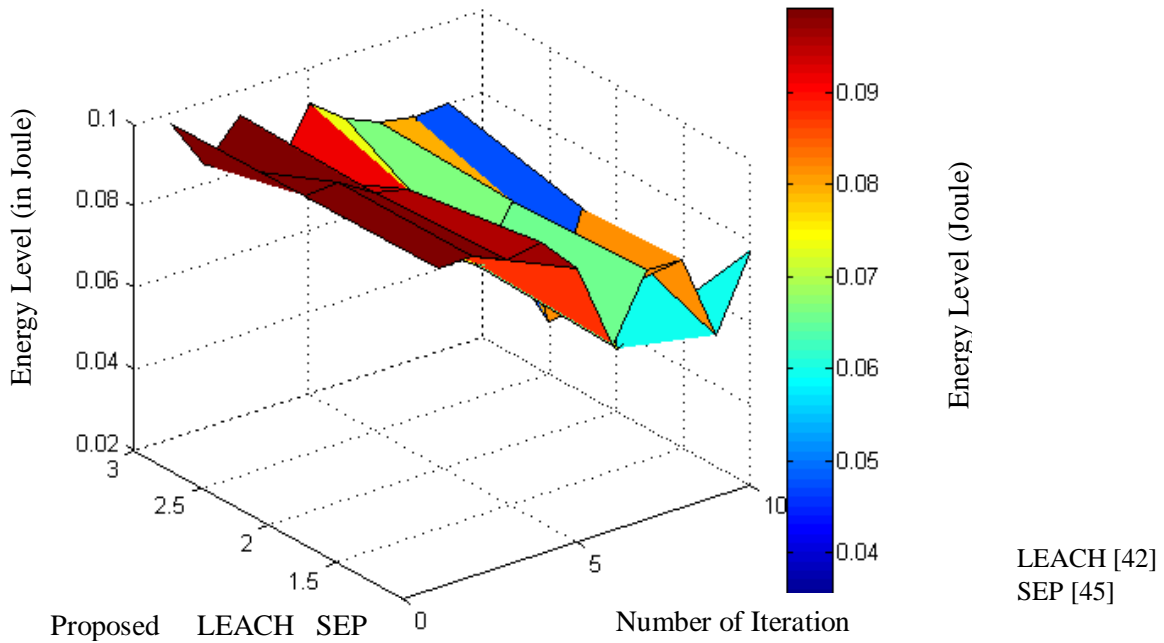

**Figure 5.4** Average Energy in 3D for 10 Iteration

Figure 5.4 represents the average energy of the network in 3D. the x-axis represents the number of iteration, the y-axis represents the approaches and the z-axis represents the energy level in joule.

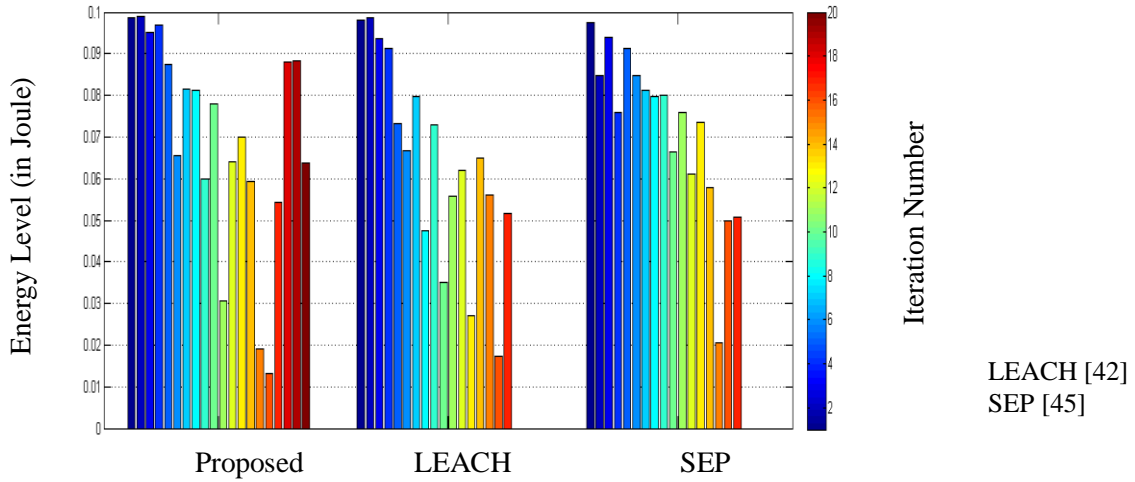

**Figure 5.5** Average Energy for 20 Iteration

Figure 5.5 shows the average energy of the network. The X-axis represents the number of iterations with approaches and y-axis represents the energy level in joule. At the starting simulation, each approach has the same energy but after simulation (20<sup>th</sup> iteration) each approach has a different energy level. The proposed approach has a higher energy level as compared to the existing approaches.

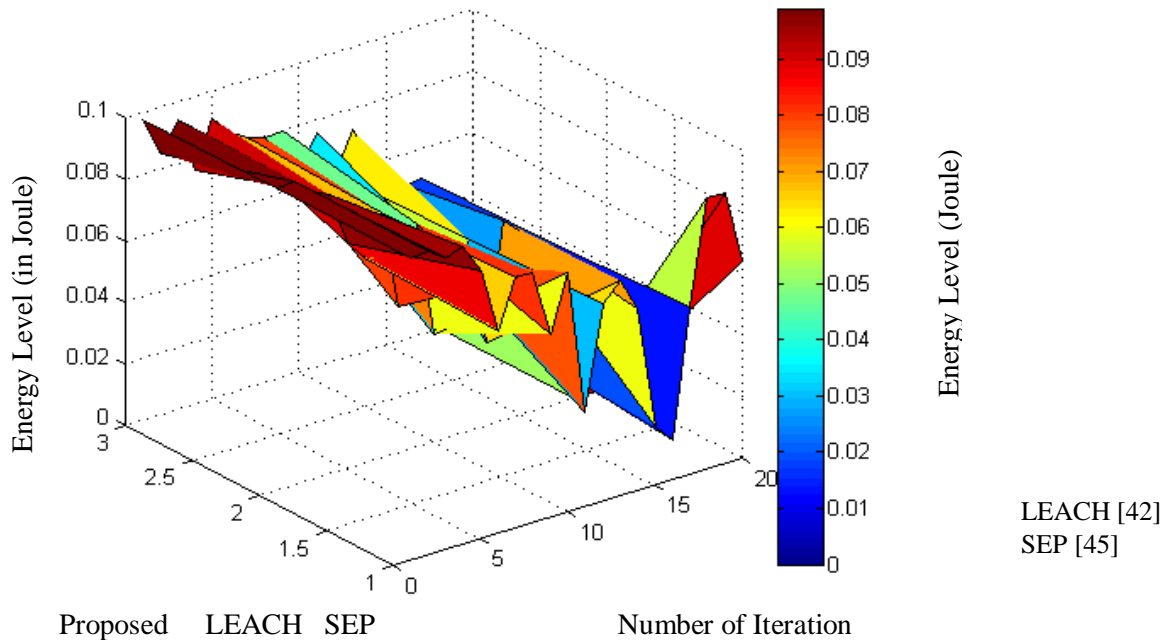

**Figure 5.6** Average Energy in 3D for 20 Iteration

Figure 5.6 shows the average energy of the network in 3D. The x-axis represents the number of iteration, the y-axis represents the approaches and the z-axis represents the energy level in joule.

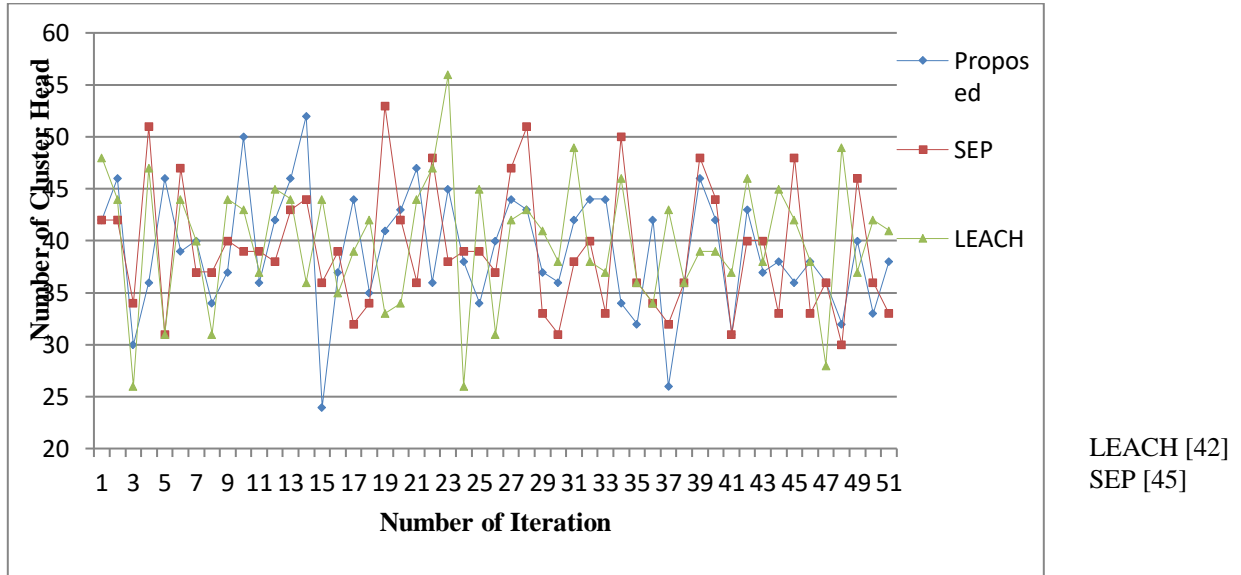

**Figure 5.7** Number of Cluster Heads in the Network

Figure 5.7 shows the number of cluster heads at a particular iteration number. The X-axis represents the number of iteration and y-axis represents the number of cluster head.

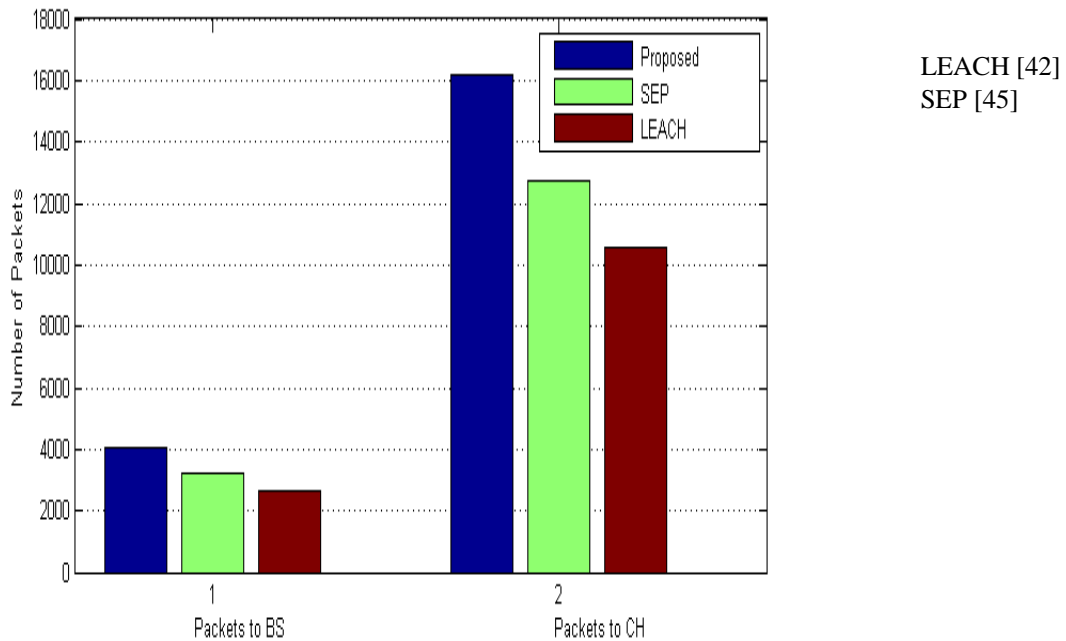

**Figure 5.8** Number of Packets Reached Base Station and Cluster Head

Figure 5.8 shows the throughput of the network. Basically, the numbers of packets reached the base station are known as the throughput of the network. The X-axis represents the packets reached the base station and packets reached cluster head, the y-axis represents the number of packets.

## **5.4 Summary**

Energy consumption is one of the most vital issues in WSNs, because the rechargeable battery is quite difficult in real-time scenarios. So save energy consumption is the ultimate goal to improve the network lifetime. Two-tier architecture's motto has categorized the nodes into two regions. Nodes those having higher RSP values come into the primary tier. The chances of cluster head selection nodes high are in the primary tier. In this chapter proposed approach has reduce the energy consumption and after the simulation, network has higher residual energy as compare to the existing approaches. In addition, to reduce the energy consumption network throughput has improved as compared to the existing approaches. In the future, a two-tier architecture may be used to improve the network lifetime, end to end delay of the network.

## CHAPTER 6

# HETEROGENEITY IN WIRELESS SENSOR NETWORKS

### 6.1 Introduction

A multi-objective optimization technique has addressed to cover up the issues and challenges related to network lifetime in wireless sensor networks. Multi-objective optimization has three types of techniques: optimization strategies, MOO algorithms, and software tools. WSN is a combination of sensor nodes [75]. Network divides into some parts in their algorithm and sensor nodes communicate to neighbors based on residual energy present at the node. The improved multi-objective weighted clustering algorithm used four parameters: (i) amount disparity of sensor node  $i$  (ii) energetic characteristic of sensor node  $i$  (iii) mission distance of sensor node  $i$  (iv) sum of distance among sensor node  $i$ . enhanced multi-objective biased clustering algorithm compared with sorting genetic algorithm and found that it is better (45% reduced energy consumption) as compared to the existing algorithm. In [76] authors have discussed on network lifetime from initial phase network deployment to completely network disabled. The algorithm's main motto is to decide the border of the energy gap in the information congregation phase in wireless sensor networks. Both spatial and temporal evolution applies in analytical results to measure the energy hole in the networks. Sensor nodes have deployed in the circular way in a homogenous network. Network lifetime is measured in terms of rounds. Sensor nodes have two stages first one is the active stage and the second one is the sleep stage. The ratio of active and sleep time called the duty cycle of the network. Network is disabled in two cases; first one when all sensor nodes die and second one gateway node not received information of sensor nodes even nodes are alive. In [77] analyzed a k-hop algorithm to equilibrium the energy utilization in WSNs. One of the constraints of WSN is that it cannot send and receive the information at a point. Linear network has been considered for result analysis with a TDMA algorithm. The optimal value of  $k$  leads to the better network lifetime. Basically,  $n$  is the number of sensor nodes and  $k$  is the hop integer, so it is expected that  $n \gg k$ . long et al. have extended the network as of one bound to k-bound in their work along with TDMA algorithm. So, the common k-bound network has a better network lifetime as compared to the one-hop networks. In [78] explained an approach that has used an additional term called a supercluster head. Supercluster head is used to throw information from the bunch to

base stations. Supercluster head may change with the help of applying some rules based on the mobility of the gateway node, remaining battery power and centrality of clusters. They have used a fuzzy inference rule (Mamdani) to choose the super bunch leader in the system. The idea of mobility sinks along with super cluster head increases the network's lifetime. In [79] suggested the idea of complexity calculation in 1-D and 2-D network topology. 1-D network topology having  $\log n$  approximation time. The maximum lifetime coverage problem can not solve in linear time or less than  $\log n$  time. They have analyzed two algorithms first one is the maximum lifetime coverage problem and the second one is dislodged position face dilemma. Dislodge position face dilemma is an NP-Complete problem. In [80] analyzed three types of data aggregation methods;(i) Full aggregation, (ii) non-aggregation and (iii) hybrid partial aggregation. Full aggregation means a sensor node received information from all its kids including self-node, cumulative the information and then send to the base station. Non-aggregation means intermediates node send the information frankly to the gateway node and hybrid partial aggregation means data aggregation based on a threshold value, if the information is beyond the verge value the sensor node send it to the gateway node otherwise will not send to the gateway node. Solutions for all three models are based on mixed-integer linear programming. Tenfold method is used for the validation of the results. In [81] discussed the recent issues and problems regarding wireless sensor networks. In [82] projected a novel steering technique based on ACO. The main motto of the algorithm is to decreases the energy expenditure in the system indirectly increases the network lifetime. This chapter introduces the heterogeneity in wireless sensor networks.

## 6.2 Proposed Model

The proposed model is explained in this section. Assumptions taken the proposed model are as follows-

- Each and every node having the same capabilities in terms of processing the data, communication among other nodes.
- All nodes along with the coordinator node are static (not movable) after the deployment.
- The recharge of the battery is not feasible after the deployment of the network.
- There is no GPS facility available for sensor nodes for their positioning.
- All nodes support data aggregation.

- Nodes are either homogeneous or heterogeneous. It is not possible to work for a node in both homogenous and heterogeneous states.
- Power consumption is the same in transmission or reception mode. It signifies that links among the sensor nodes are symmetric.
- There is only a single node (cluster head) that has no constraints regarding memory, power supply, and energy consumption.

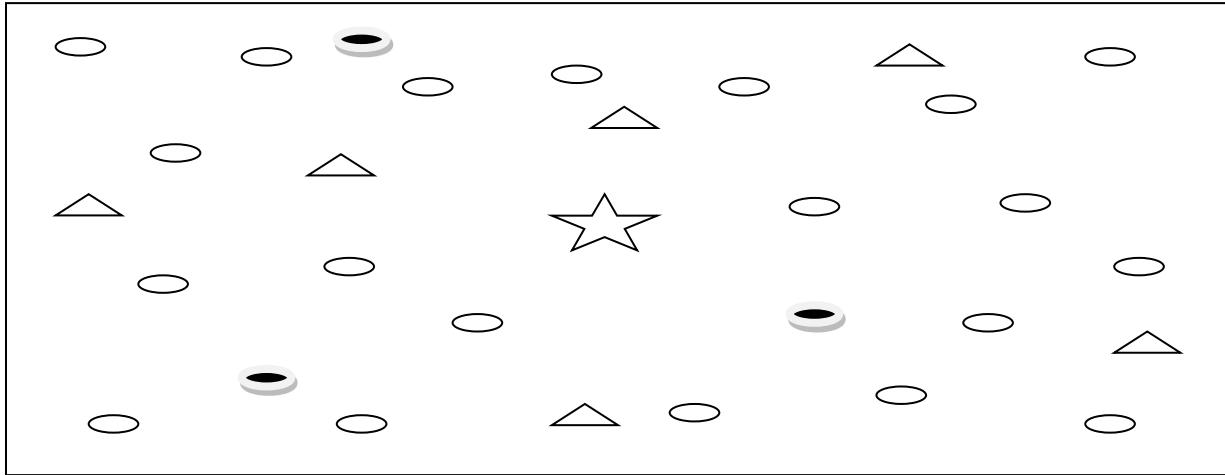

**Figure 6.1** Heterogeneous Network

Figure 6.1 shows the model of a heterogeneous network where three types of sensor nodes. Normal sensor nodes have denoted by  $\circ$ , advanced sensor nodes have denoted by  $\triangle$ , and supernode sensor nodes have denoted by  $\bullet$ . Base station has denoted by  $\star$ .

The proposed model has 3 types of sensor nodes ; (i) normal nodes, (ii) advanced nodes and (iii) supernodes. Total numbers of nodes are  $N$ . Supernodes have more initial energy as compared to advanced nodes and advanced nodes have more energy as compare to the normal nodes. Supernodes have a high cost because they have more energy so to balance the energy as well as the cost we setup friction of supernodes and advanced nodes.  $N * \omega$  nodes have minimum energy, here we have taken  $\omega$  value between 0 to 1.  $N * \omega$  nodes are called normal nodes and energy is  $E_0$ .  $N * \omega^2$  nodes are advanced nodes and energy is  $E_1$ . Remaining nodes  $(N - (N * \omega + N * \omega^2))$  have maximum energy denoted as  $E_2$  and called as super nodes.

$$(N - (N * \omega + N * \omega^2)) < N * \omega^2 < N * \omega \quad (6.1)$$

$$E_2 > E_1 > E_0 \quad (6.2)$$



Eq. (1) tells about the number of nodes in the system. Normal nodes are more as compare to the advanced nodes. And advanced nodes are more as compare to the supernodes in the network.

Eq. (2) tells about the energy of the network,  $E_2$  super nodes have the highest energy in the network as compare to the advanced nodes and normal nodes.  $E_1$  Advanced nodes have more energy as compare to the normal nodes.

$$Total\_E = N * \omega * E_0 + N * \omega^2 * E_1 + (1 - \omega - \omega^2) * N * E_2 \quad (6.3)$$

Eq. (3) explains the heterogeneity of the network, if we put  $\omega = 0$  then network consists only supernodes in the network because the first two terms become zero. The network behaves as a uniform system because the system has only one type of node (super nodes).

### 6.2.1 CH Selection

Cluster head (Bunch Leader) selection procedure is discussed in this section. In proposed model nodes having more residual energy will get more chance to became bunch leader as compared to the nodes those having less energy. The model has three types of nodes normal nodes, advanced nodes, and supernodes. Each type of node has a different probability to become a cluster-head. Advanced nodes have  $(1 + \alpha)$  times more chance to became cluster head as compared to the normal nodes. Supernodes have  $(1 + \beta)$  times more chance to become a cluster head as compare to the normal nodes.

$$P_N = \frac{P_{opt} * E_i(r)}{\left( \omega + \omega^2 * \frac{E_1}{E_0} + (1 - \omega - \omega^2) * \frac{E_2}{E_0} \right) E(r)} \quad (6.4)$$

Eq. (4) has been used to calculate the possibility of node to become a bunch leader. Where  $P_N$  is the probability to become bunch leader  $i$  node from normal nodes.  $E_i(r)$  is the remaining energy of the  $i$ th node and  $E(r)$  is the standard residual energy of the system.

$$P_A = (P_{opt} (1 + \alpha) * E_i(r)) / ((\omega + \omega^2 * E_1/E_0 + (1 - \omega - \omega^2) * E_2/E_0) E(r)) \quad (6.5)$$

Where  $P_A$  is the possibility to become a bunch leader node from advanced nodes.

$$P_S = (P_{opt} (1 + \beta) * E_i(r)) / ((\omega + \omega^2 * E_1/E_0 + (1 - \omega - \omega^2) * E_2/E_0) E(r)) \quad (6.6)$$

Where  $P_S$  is the possibility to become a bunch leader node from super nodes.

$$T(n) = \{(P/(1 - P * (r \bmod 1/P)) \text{ if } n \in G \quad 0 \text{ otherwise)} \quad (6.7)$$

$$T(n) = \begin{cases} \frac{P_N}{1 - P_N * (r \bmod \frac{1}{P_N})} \text{ if } P_N \in G \\ \frac{P_A}{1 - P_A * (r \bmod \frac{1}{P_A})} \text{ if } P_N \in G' \\ \frac{P_S}{1 - P_S * (r \bmod \frac{1}{P_S})} \text{ if } P_N \in G'' \\ 0 \text{ otherwise} \end{cases} \quad (6.8)$$

Where  $G$  is the set of normal nodes,  $G'$  is the set of advanced nodes and  $G''$  is the set of super nodes. Here we have adopted a similar approach as in eq. (7) LEACH approach to determine the possibility of a node to become a bunch leader. Eq. (5) to Eq. (8) are used to calculate the possibility of a sensor node to become a bunch leader.

---

**Algorithm 6.1** Nodes Categorization

---

**Input:** N number of nodes

**Output:** Nodes categorized into clusters

**Begin**

1. **for**  $i = 1$  to N
2.     **if** node (i) energy = high
3.         node (i)  $\leftarrow$  super node
4.     **else if** node (i) energy = medium
5.         node (i)  $\leftarrow$  advanced node
6.     **else** node (i)  $\leftarrow$  normal node
7.     **end if**
8. **end for**

**End**

---

Algorithm 6.1 is used to node categorization. Nodes have categorized into three categories (normal nodes, advanced nodes, and super nodes) based upon the energy level of the nodes.

### 6.2.2 Flow Chart of Proposed Model

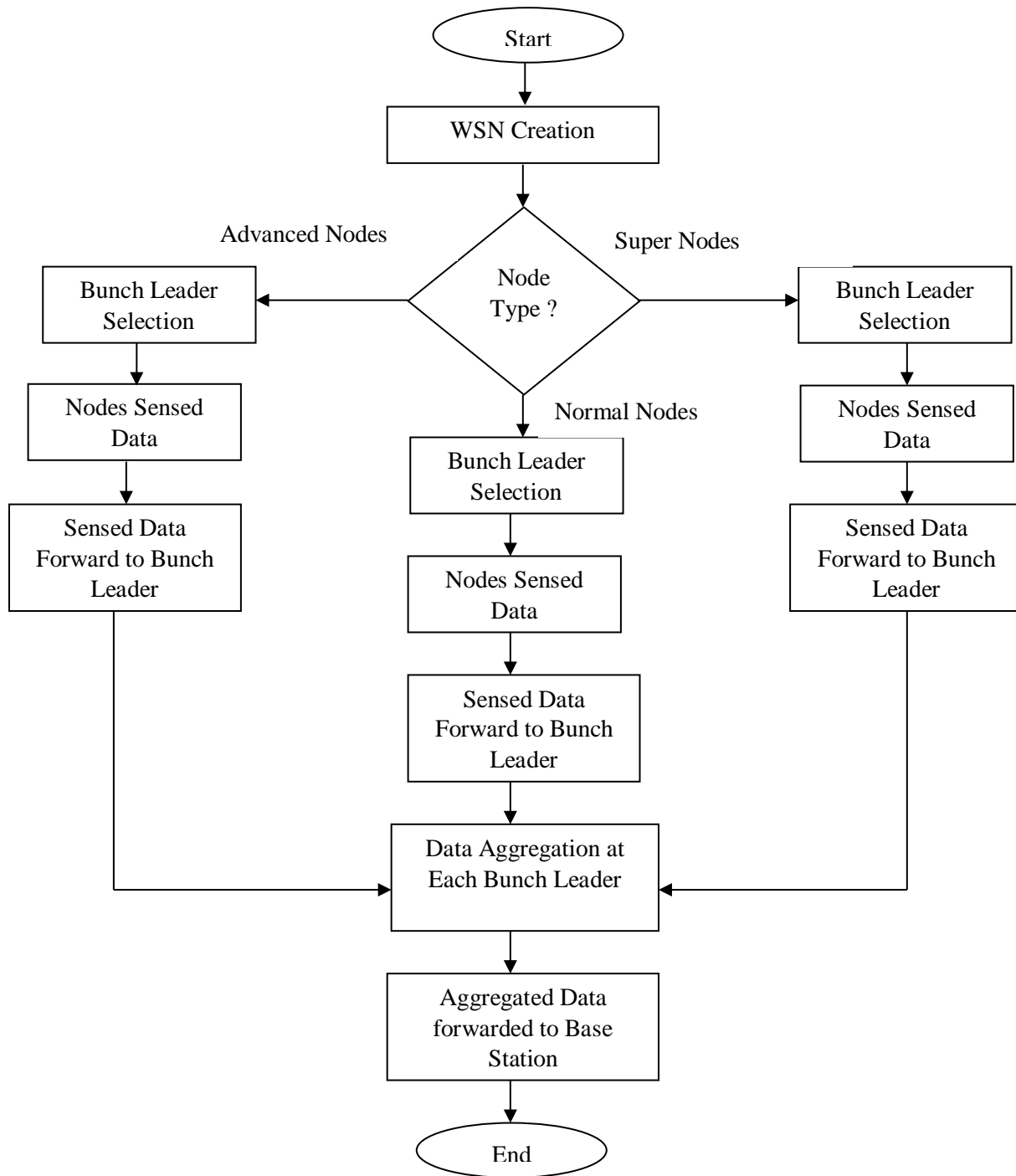

**Figure 6.2** Flow Chart of the Heterogeneous network

Figure 6.2 represents the flow chart of the proposed model. First, we create the WSN, then a number of nodes categorized into three types of nodes: normal nodes, advanced nodes, and supernodes.

After that CH selection takes place in each type of sensor node with different probabilities. All sensor nodes sense the data and forwarded it to the cluster head. Data aggregation takes place at each cluster head and finally aggregated data forwarded to the base station.

---

**Algorithm 6.2** Cluster Head Selection

---

**Input:** T number of nodes and l number of cluster head

**Output:** l nodes having the highest value of Q.

**Begin**

1.  $T(k).d_j$ : criteria value for node k with criteria j
2. n: criteria number
3. o: number of alternatives
4. **for** j= 1 to n
5.     **for** k = 1 to o
6.      $q_{jk} = \frac{T(k).d_j}{\sum_{v=1}^o T(v).d_j}$
7.     **end for**
8.      $I_j = -\frac{1}{\log_2 n} \sum_k q_{jk} \log_2 q_{jk}$
9. **end for**
10. **for** j=1 to n
11.  $v_j = \frac{(1-I_j)}{n-\sum_j I_j}$
12. **end for**
13. **for** k= 1 to o
14.  $T(k).Q = \prod_{j=1}^n (T(k).d_j)^{v_j}$
15. **end for**
16. Return the value of l from the nodes T which is the highest of Q.

**End**

---

Algorithm 6.2 is used to cluster head selection.

### 6.2.3 Simulation Setup

The proposed work has implemented on Matlab 2013 a. We have taken a 100 meter \* 100-meter area for wireless sensor networks. Sink node positioned at the center.

**Table 6.1** Simulations Parameters

S.No.	Parameter	Value
1	Number of Iterations	4000
2	Nodes	100, 50
3	DA Energy	5 nano Joule
4	Initial Energy of Normal Nodes	.5 Joule
5	Network Area	100 M *100M
6	Sink Node Position	50,50

In the next section, we have analyze the results for better interpretation to understanding the proposed work suitable figure displayed.

#### **6.2.4 Performance Parameters**

Basically, the two performance parameters analyzed in this chapter. (i) Network Lifetime (ii) Throughput of the network

- (i) Network Lifetime depends upon a number of parameters like the number of alive nodes in the system, sensor exposure, connectivity, etc. [83]. The number of alive nodes for system lifetime considered in this paper. Figure 6.8 and 6.9 represents the network lifetime of the proposed method.
- (ii) The number of packets reached at the gateway node per unit time is called a throughput of the system [84]. Figure 6.6 and 6.7 shows the throughput of the network in the proposed approach.

#### **6.3 Analysis on Results**

This section represents the result analysis. Figures are maintained to better understand the results.

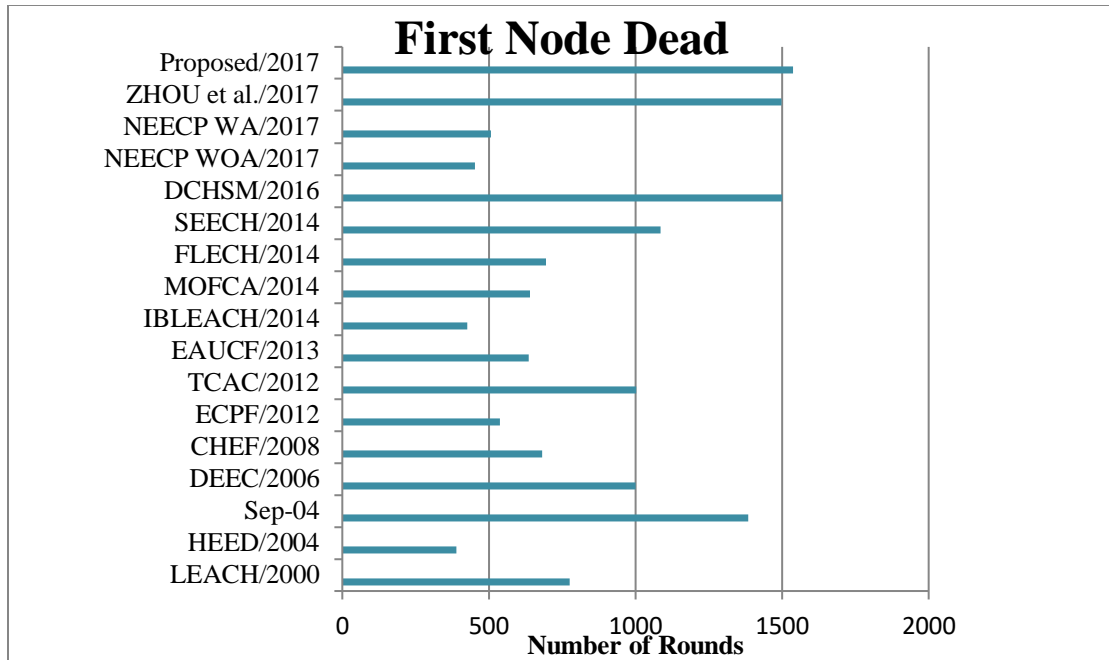

**Figure 6.3** First node dead in different techniques

In figure 6.3, the comparison of first node dead in the network are shown where the proposed approach is compared with existing 16 other approaches from the year 2000 to the year 2017. The first node get dead at the 1537<sup>th</sup> round in the proposed method, which is better as compared to the existing other methods.

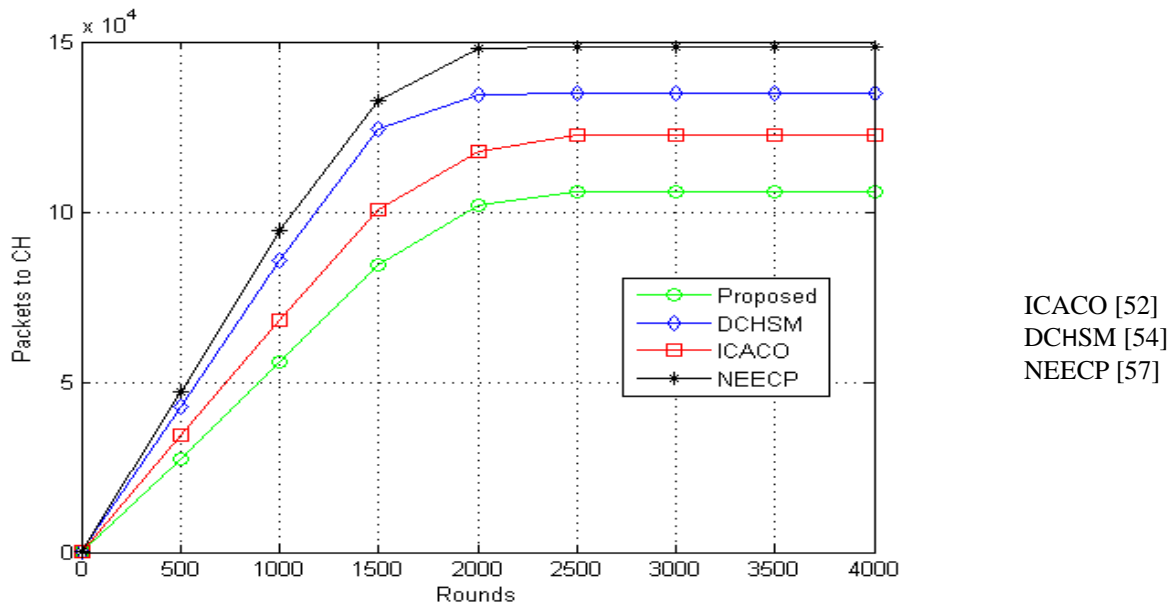

**Figure 6.4** Packets Reached at the Cluster head with 100 Nodes

Figure 6.4 shows the packets reached the cluster head. In novel energy-efficient clustering protocol (NEECP) 154706 packets are reached at CH. In dynamic cluster head selection method (DCHSM) 142305 packets are reached at cluster head. In inter-cluster ant colony optimization (ICACO) 126968 packets are reached at the cluster head. In the proposed approach 108634 packets are reached at cluster head those are less as compared to other approaches.

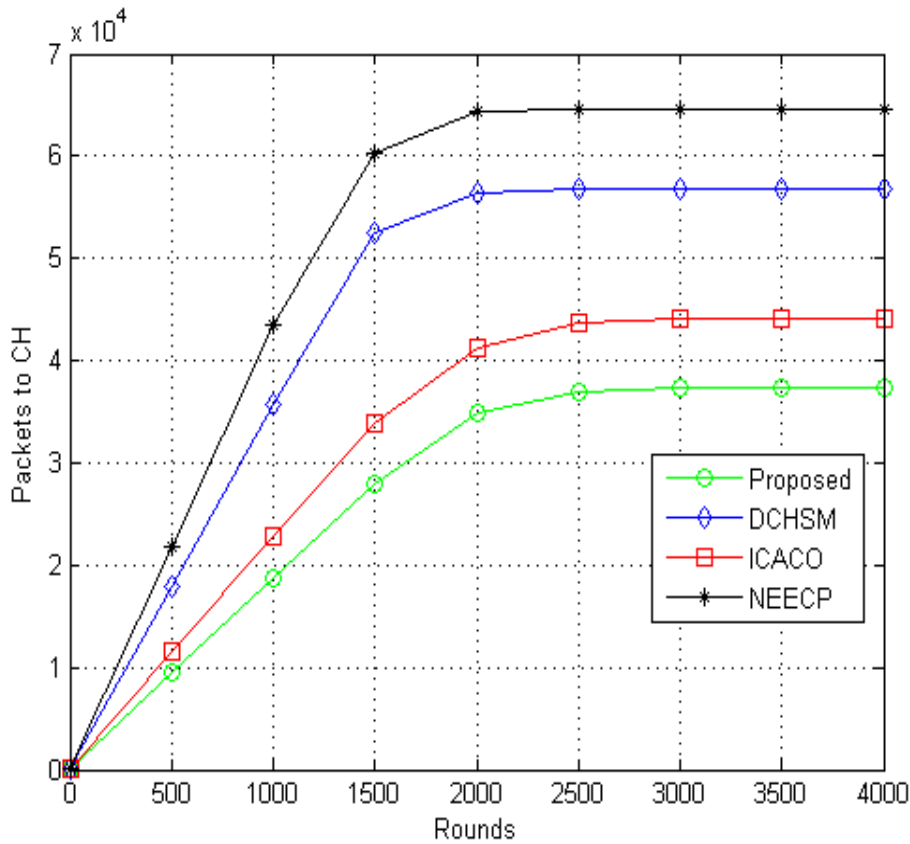

ICACO [52]  
DCHSM [54]  
NEECP [57]

**Figure 6.5** Packets Reached at the Cluster head with 50 Nodes

Figure 6.5 illustrates the number of packets that reached the cluster head. In the proposed approach, fewer packets reached the cluster head as compared to the DCHSM, ICACO and NEECP approaches.

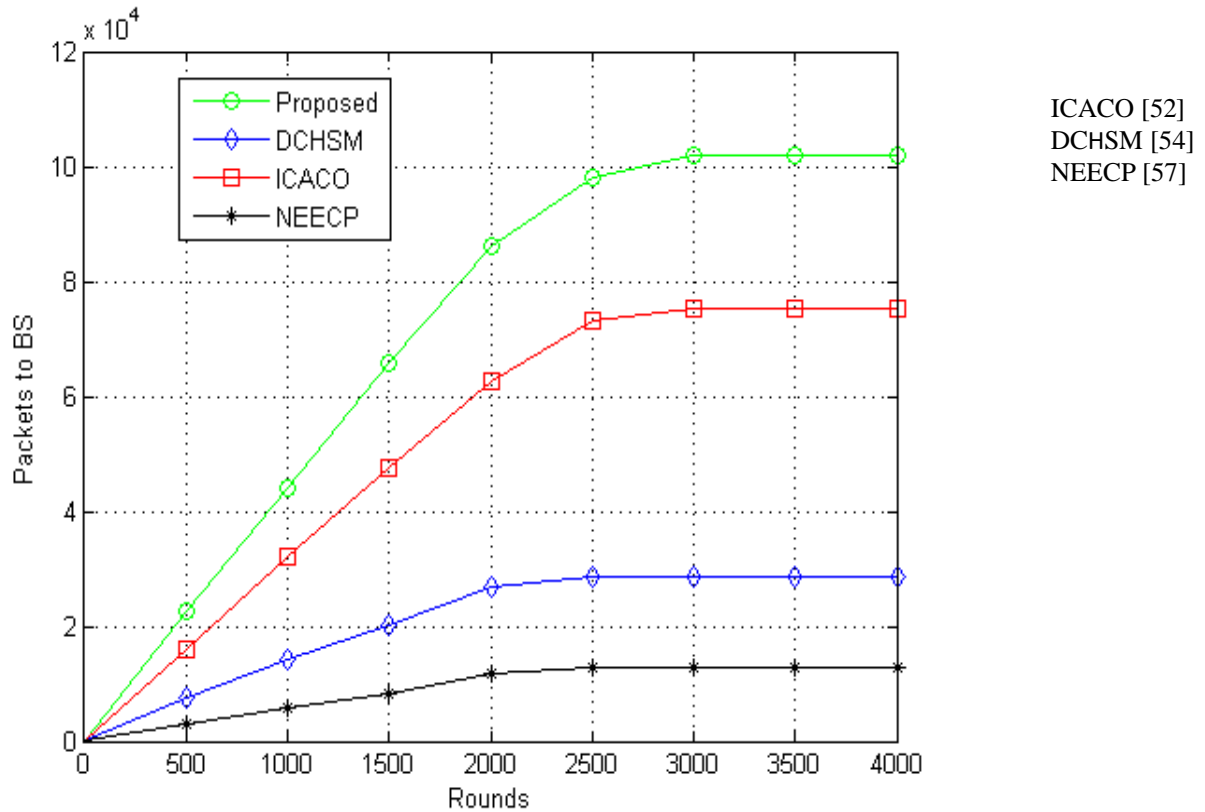

**Figure 6.6** Packets Reached at Base Station with 100 Nodes

Figure 6.6 shows the packets reached the gateway node. In novel energy-efficient clustering protocol (NEECP) 13217 packets are reached at the base station. In dynamic cluster head selection method (DCHSM) 26458 packets are reached at the base station. In inter-cluster ant colony optimization (ICACO) 78830 packets are reached at the gateway node. In the proposed method, 119564 packets are reached at base station those are more as compare to other approaches.



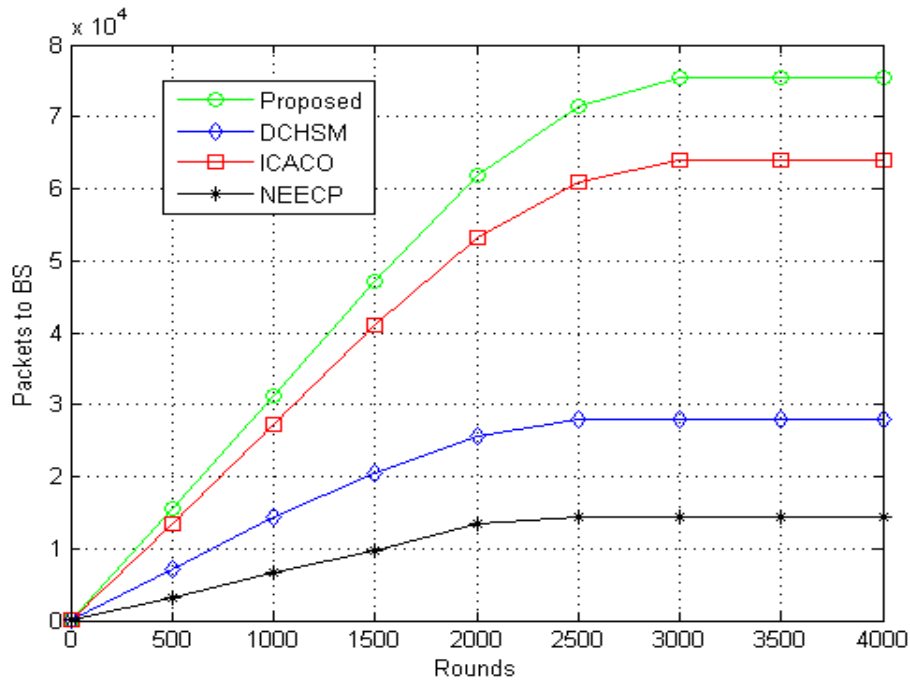

ICACO [52]  
DCHSM [54]  
NEECP [57]

**Figure 6.7** Packets Reached at Base Station with 50 Nodes

Figure 6.7 illustrates the packets reached at the sink node with 50 numbers of nodes. The figure clearly shows that the proposed approach is better as compare to the DCHSM, ICACO and NEECP approach.

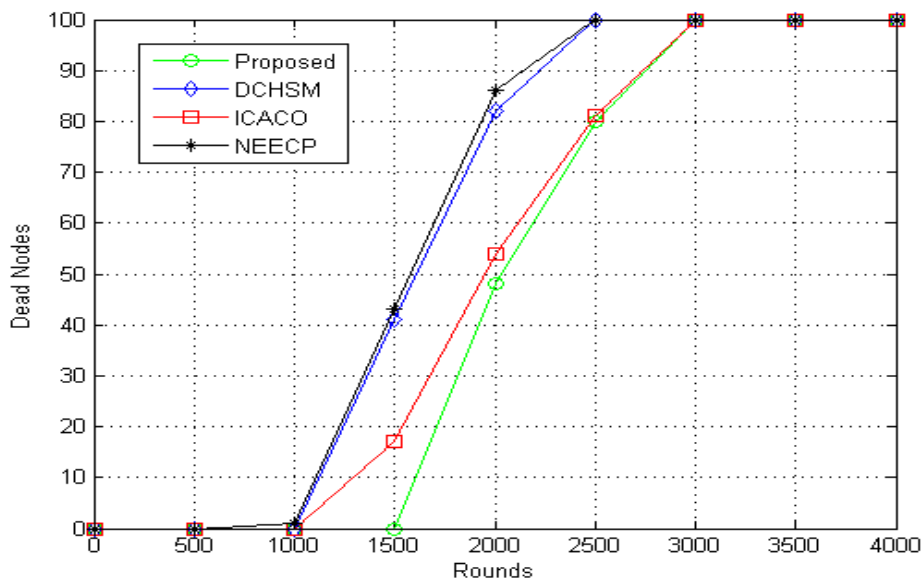

ICACO [52]  
DCHSM [54]  
NEECP [57]

**Figure 6.8** Dead nodes with 100 Nodes

Figure 6.8 represents the number of dead nodes at different rounds in the network. In novel energy-efficient clustering protocol (NEECP) first node died at 994<sup>th</sup> round. In dynamic cluster head selection method (DCHSM) first node dead at 1199<sup>th</sup> round. In inter-cluster ant colony optimization (ICACO) first node died at 1289<sup>th</sup> round. In the proposed approach first node dead at 1537<sup>th</sup> round which is the highest value as compare to other approaches.

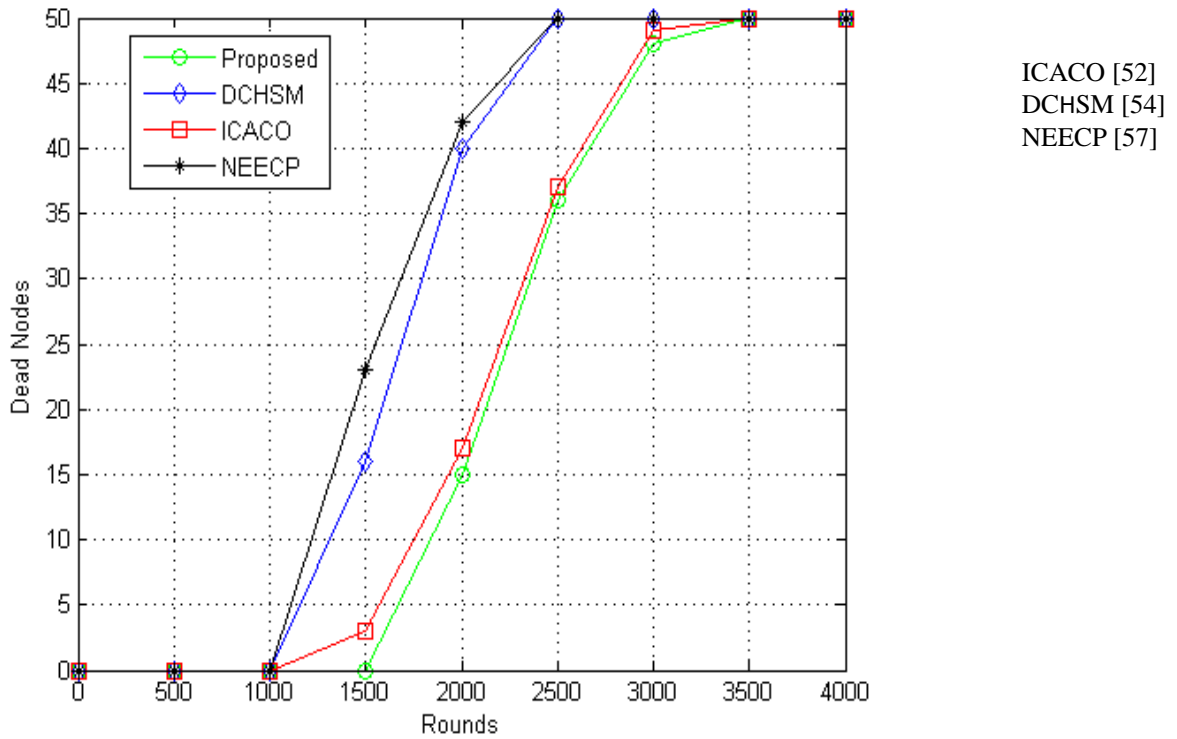

**Figure 6.9** Number of Dead nodes with 50 Nodes

Figure 6.9 illustrates the number of dead nodes with 50 numbers of nodes. First node dead in the proposed approach near about 1500 number of rounds while other approaches first node dead near about 1000 number of rounds. So the proposed approach has a better network lifetime as compared to the existing approaches.

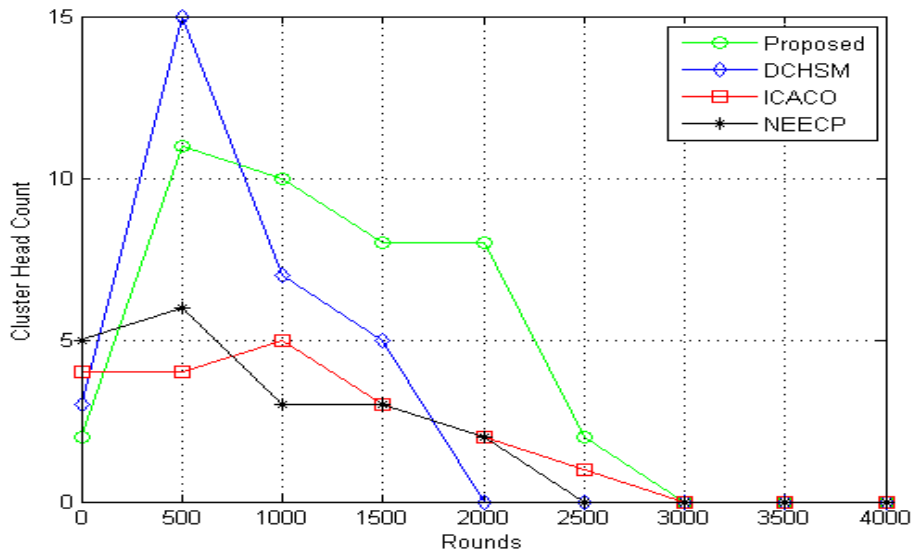

ICACO [52]  
DCHSM [54]  
NEECP [57]

**Figure 6.10** Number of Cluster head with 100 Nodes

Figure 6.10 represents the number of CH in the network at different rounds. Where, the proposed approach having more number of cluster head as compared to existing approaches.

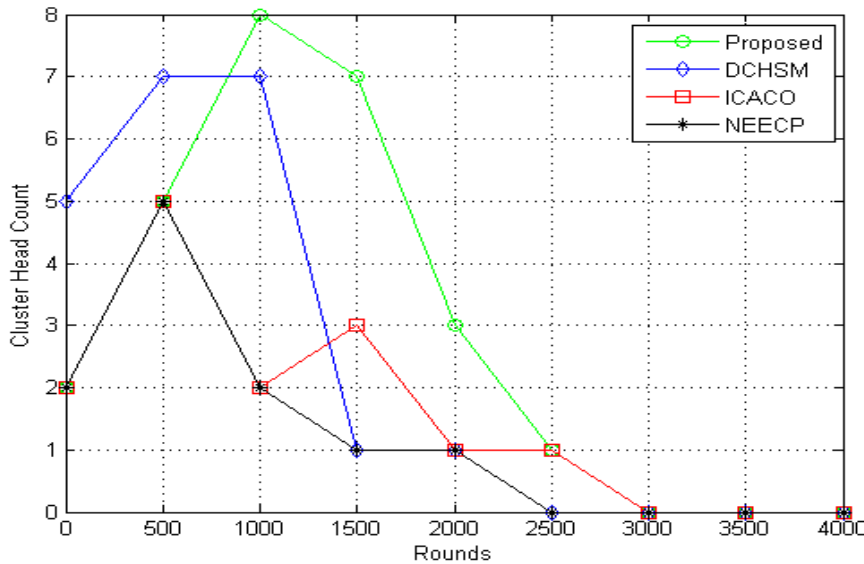

ICACO [52]  
DCHSM [54]  
NEECP [57]

**Figure 6.11** Number of CH with 50 Nodes

Figure 6.11 illustrates the number of cluster heads with 50 numbers of nodes. On average after the simulation completion, it has been found that the proposed approach has a higher number of cluster heads as compared to the existing approaches.

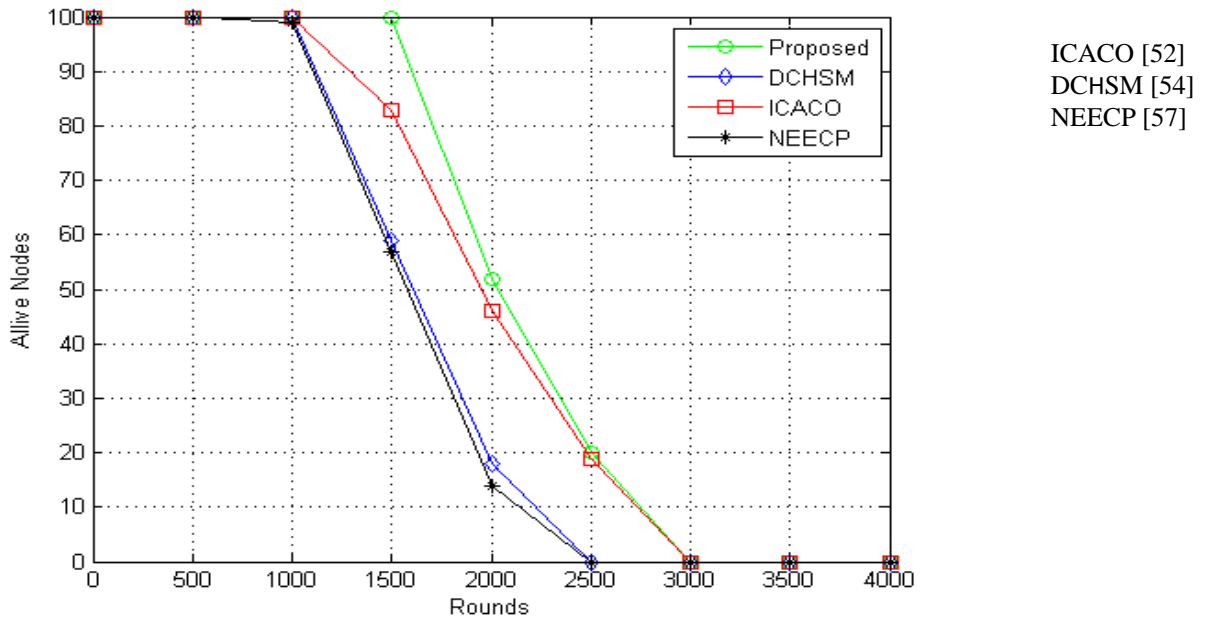

**Figure 6.12** Alive Nodes with 100 Nodes

Figure 6.12 represents the number of alive nodes in the network. In novel energy-efficient clustering protocol (NEECP) all sensor nodes died at 2325<sup>th</sup> round. In the dynamic cluster head selection method (DCHSM), all sensor nodes died at 2395<sup>th</sup> round. In inter-cluster ant colony optimization (ICACO) all sensor nodes died at 2913<sup>th</sup> round. In the proposed approach all sensor nodes died at 2948<sup>th</sup> round which is the highest value as compare to other approaches.

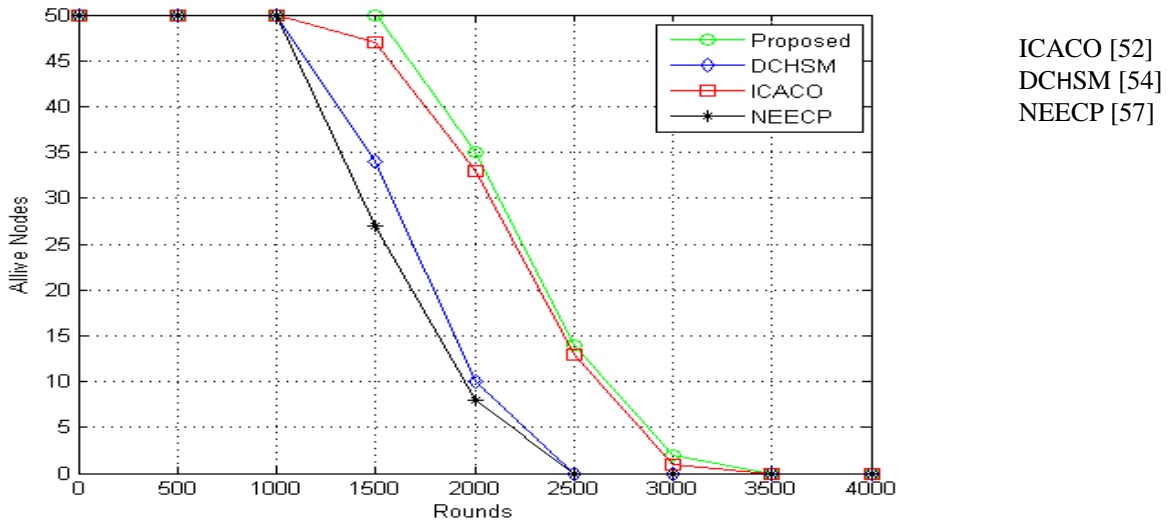

**Figure 6.13** Number of Alive Nodes with 50 Nodes

Figure 6.13 illustrates the number of alive nodes with 50 numbers of nodes. The proposed approach has a better lifetime of the network as compared to the DCHSM, ICACO and NEECP approach.

## **6.4 Summary**

The proposed approach is based on multilevel heterogeneity. In this paper, we have used three types of sensor nodes in wireless sensor networks; normal nodes, advanced nodes, and supernodes. All nodes have the same capabilities for transmitting, receiving and processing the data. Normal nodes advanced nodes and supernodes only one difference that is the initial energy of nodes. Supernodes have higher initial energy and normal nodes have lower initial energy. Advanced nodes have initial energy in between among supernodes and normal nodes. We have compared our work with existing approach NEECP, ICACO, and DCHSM. Alive nodes, dead nodes, and packets reached bunch leader, the number of bunch leader and packets reached gateway node are the performance parameters. In the future, the same work may be done using artificial intelligence techniques and also try for a large system in terms of sensor nodes. Power consumption may combine with this work to improve the network lifetime and increase network reliability also.

# CHAPTER 7

## FUZZY LOGIC IN WSN

### 7.1 Introduction

In the modern era, numbers of heuristic, meta-heuristic, artificial intelligence-based techniques are used in WSNs. Each and every technique has its own advantages and disadvantages. In this chapter fuzzy logic based technique has been used to improve the network lifetime and throughput of the network in wireless sensor networks. The Combination of sensor nodes make WSNs. These sensor nodes have own computing power, sensing range, transmitting range and processing power. Energy efficiency is one of the most important challenges in wireless sensor networks. Network lifetime depends upon energy efficiency. Means if the network is more energy efficient then network lifetime will more. The cluster-based approach is one of most suitable techniques for an energy-efficient approach. Network is divided into number of clusters in the cluster-based approach. Each cluster has a cluster head. Sensor node sends the data to the cluster head and then cluster head sends the data to the base station [85]. Sensor nodes are equipped with the radio transceiver, receivers, and microprocessors. Cluster head selection is based on a fuzzy inference system with the help of suitable parameters. Fuzzy inference system is based on the fuzzy rule “if-then”. Basically, there are three main terms in the fuzzy logic system (input, FIS, and output). The fuzzy inference system has three models (Mamdani, Sugeno, and Tsukamoto). Out of these three models, Mamdani is the most popular in many literature surveys [86]. Three parameters (battery level, distance from sink node and node density) are taken as input parameters to calculate the chances of a node to become cluster head as an output parameter [87]. Applications of wireless sensor networks are categorized into two categories. First one is data gathering and the second one is data processing and data transportation. The data gathering category generally focuses on event monitoring in a simple way. Data processing includes video surveillance and industrial monitoring in a complex way. Cluster head selection is based on global trace search [88]. Multimedia sensor nodes work as intermediate nodes in the network. Caching of the suitable data concept, came into multimedia sensor networks. The reduction of battery power levels may be possible with the help of the caching technique. The main challenge in a multimedia WSN is the unavailability of permanent infrastructure [89].

This chapter is focused mainly on lifetime and throughput of network. Fuzzy logic is used to calculate the network lifetime and throughput of the network. Mamdani model has been used as a fuzzy inference system. Number of nodes, number of iterations and initial energy of nodes work as input for calculate the network lifetime and throughput.

Fuzzification – Network lifetime is calculated with two input parameters, which are a number of nodes and initial energy of sensor node. Throughput is calculated with three input parameters, which are the number of nodes, the initial number of nodes and the iteration number. Triangular functions are used for fuzzification. Each input parameters have three membership functions, which are low, medium and high. Output throughput and Network lifetime have five membership functions, which are very low, low, medium, high and very high.

Inference System – After fuzzification the second phase takes place, this is the inference model. Here Mamdani model has used as a fuzzy inference system. Fuzzy rules are created in this section. There are 27 rules for Throughput and 9 rules for network lifetime.

Defuzzification – A crisp value is calculated for network lifetime and throughput of the network in the defuzzification phase. The proposed approach's values are verified with Matlab simulated results. Values are acceptable, that have found with the proposed approach.

## **7.2 Proposed Model**

Two models are designed with the help of fuzzy logic. First, one model is designed for network throughput and the second model is designed for network lifetime. There are some assumptions-

- All nodes are homogenous in terms of energy.
- Deployments of nodes are random.
- Each node can sense in 360 degrees.
- Nodes are static means after deployment there is no movement of nodes with their position.
- Communications among the nodes are symmetric.
- The base station is fixed and static.

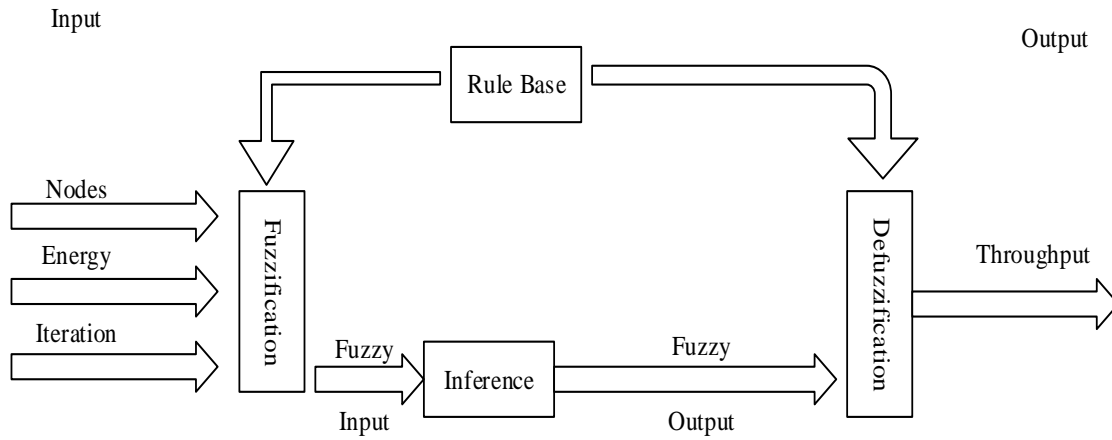

**Figure 7.1** Proposed Model for Throughput

Figure 7.1 shows the proposed model for network throughput. The number of nodes, energy and iteration number are the input parameters and throughput is the output.

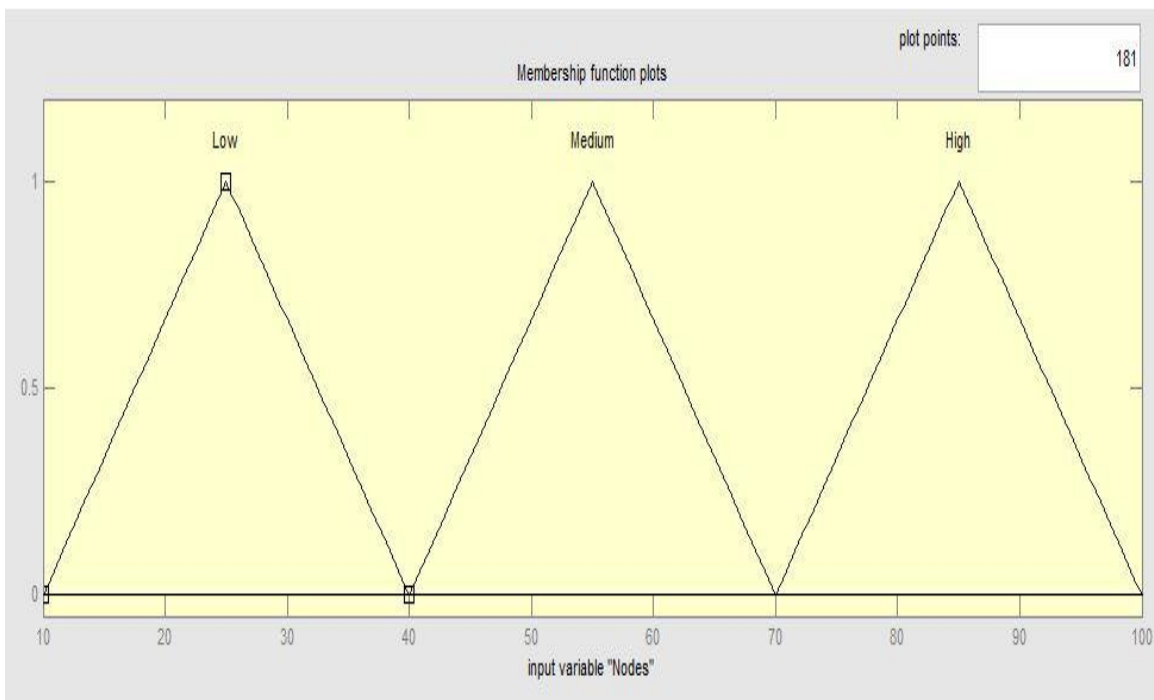

**Figure 7.2** Membership Function for Nodes

Figure 7.2 shows the membership function for the nodes. 10 to 40 nodes come low category, 40 to 70 nodes come medium category and 70 to 100 nodes come into high category.



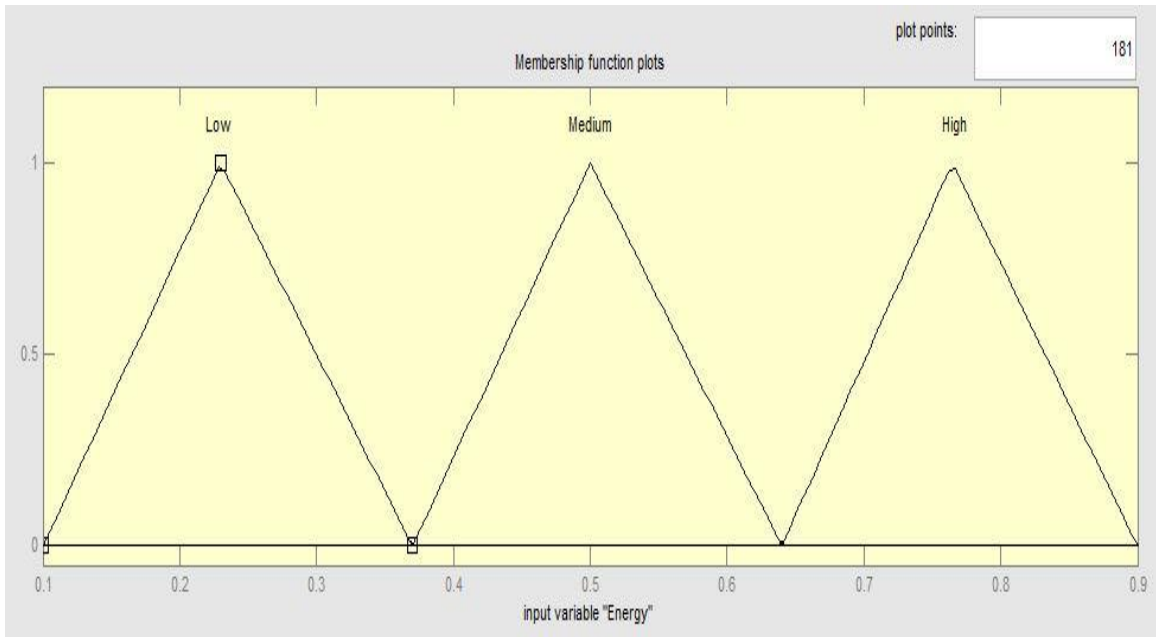

**Figure 7.3** Membership Function for Energy

Figure 7.3 shows the membership function for energy. .1 joule to .37 joule energy come into low category, .37 to 6.3-joule energy come into medium category and .63 to .9 joule energy come into high category.

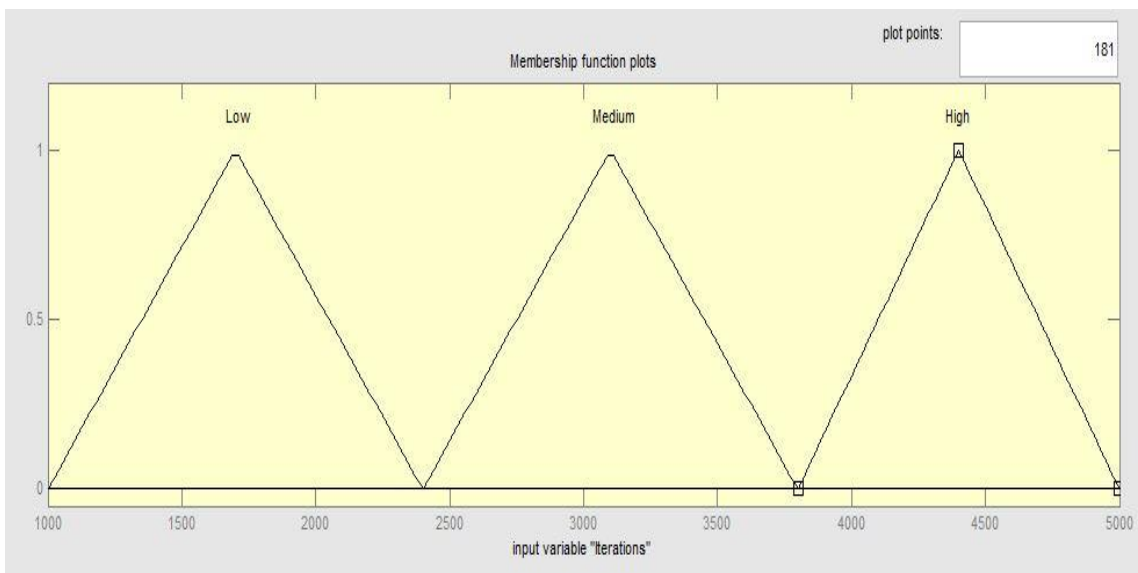

**Figure 7.4** Membership Function for Iteration

Figure 7.4 shows the membership function for the iteration. 1000 to 2400 iteration comes into low category, 2400 to 3700 iteration comes into the medium category and 3700 to 5000 iteration comes into high category.

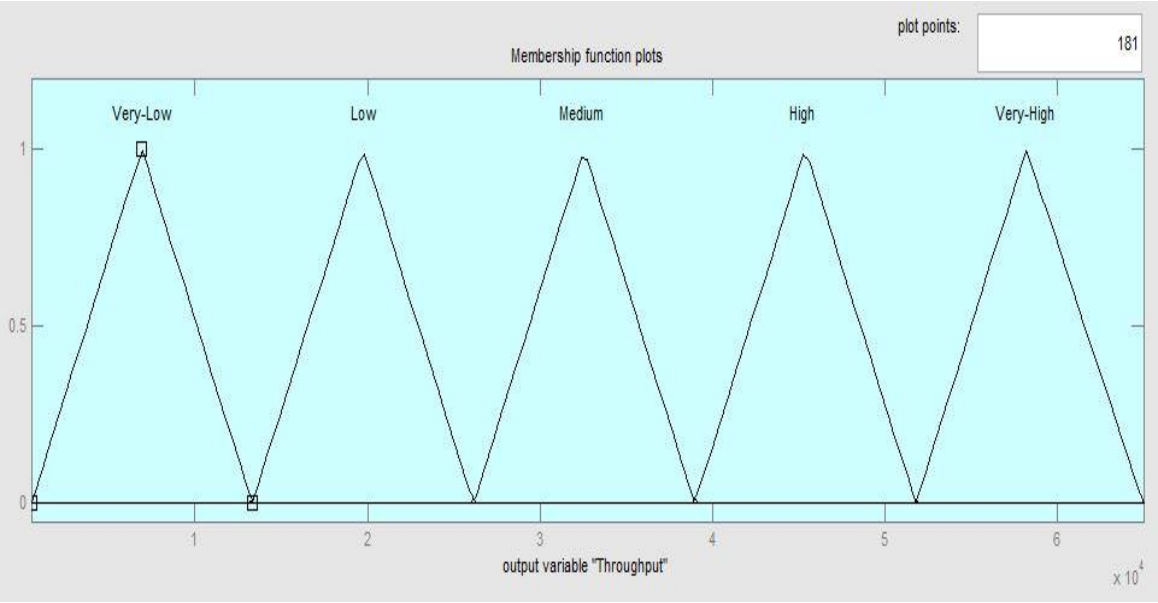

**Figure 7.5** Membership Function for Throughput

Figure 7.5 shows the membership function for the throughput. 0 to 13000 packets come into a very low category, 13000 to 26000 packets come into low category, 26000 to 39000 packets come into medium category, 39000 to 52000 packets come into the high category and 52000 to 65000 packets come into very high category.

**7.2.1 Fuzzy Rules for Throughput**

1. If (Nodes is Low) and (Energy is Low) and (Iterations is Low) then (Throughput is Very-Low)
2. If (Nodes is Low) and (Energy is Low) and (Iterations is Medium) then (Throughput is Very-Low)
3. If (Nodes is Low) and (Energy is Low) and (Iterations is High) then (Throughput is Very-Low)

4. If (Nodes is Low) and (Energy is Medium) and (Iterations is Low) then (Throughput is Very-Low)
5. If (Nodes is Low) and (Energy is Medium) and (Iterations is Medium) then (Throughput is Very-Low)
6. If (Nodes is Low) and (Energy is Medium) and (Iterations is High) then (Throughput is Very-Low)
7. If (Nodes is Low) and (Energy is High) and (Iterations is Low) then (Throughput is Very-Low)
8. If (Nodes is Low) and (Energy is High) and (Iterations is Medium) then (Throughput is Very-Low)
9. If (Nodes is Low) and (Energy is High) and (Iterations is High) then (Throughput is Very-Low)
10. If (Nodes is Medium) and (Energy is Low) and (Iterations is Low) then (Throughput is Very-Low)
11. If (Nodes is Medium) and (Energy is Low) and (Iterations is Medium) then (Throughput is Very-Low)
12. If (Nodes is Medium) and (Energy is Low) and (Iterations is High) then (Throughput is Very-Low)
13. If (Nodes is Medium) and (Energy is Medium) and (Iterations is Low) then (Throughput is Very-Low)
14. If (Nodes is Medium) and (Energy is Medium) and (Iterations is Medium) then (Throughput is Low)
15. If (Nodes is Medium) and (Energy is Medium) and (Iterations is High) then (Throughput is Low)

16. If (Nodes is Medium) and (Energy is High) and (Iterations is Low) then (Throughput is Very-Low)
17. If (Nodes is Medium) and (Energy is High) and (Iterations is Medium) then (Throughput is Low)
18. If (Nodes is Medium) and (Energy is High) and (Iterations is High) then (Throughput is Medium)
19. If (Nodes is High) and (Energy is Low) and (Iterations is Low) then (Throughput is Very-Low)
20. If (Nodes is High) and (Energy is Low) and (Iterations is Medium) then (Throughput is Very-Low)
21. If (Nodes is High) and (Energy is Low) and (Iterations is High) then (Throughput is Very-Low)
22. If (Nodes is High) and (Energy is Medium) and (Iterations is Low) then (Throughput is Very-Low)
23. If (Nodes is High) and (Energy is Medium) and (Iterations is Medium) then (Throughput is Medium)
24. If (Nodes is High) and (Energy is Medium) and (Iterations is High) then (Throughput is High)
25. If (Nodes is High) and (Energy is High) and (Iterations is Low) then (Throughput is Very-Low)
26. If (Nodes is High) and (Energy is High) and (Iterations is Medium) then (Throughput is Medium)
27. If (Nodes is High) and (Energy is High) and (Iterations is High) then (Throughput is Very-High)

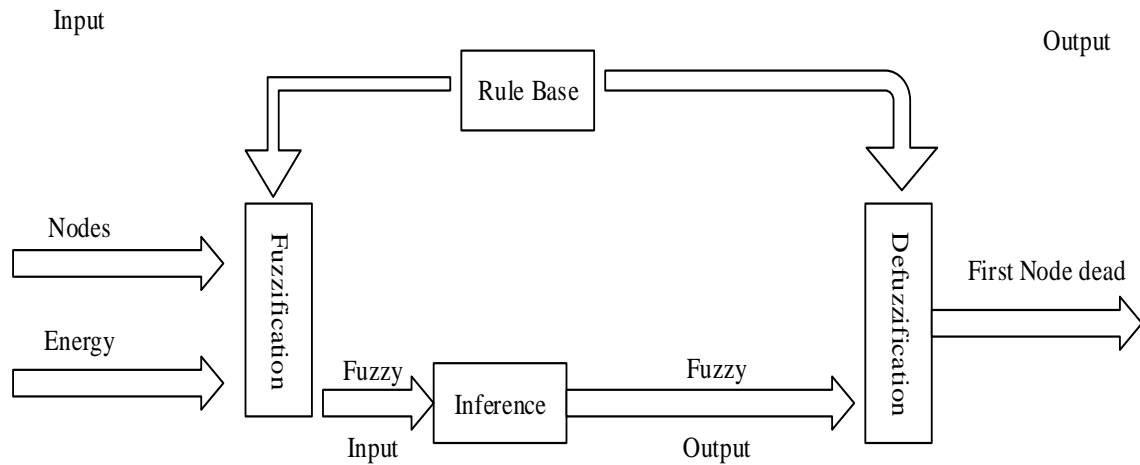

**Figure 7.6** Proposed Model for First Node Dead

Figure 7.6 shows the proposed model for the first node dead. The number of nodes and energy are the input parameters and the first node dead is the output.

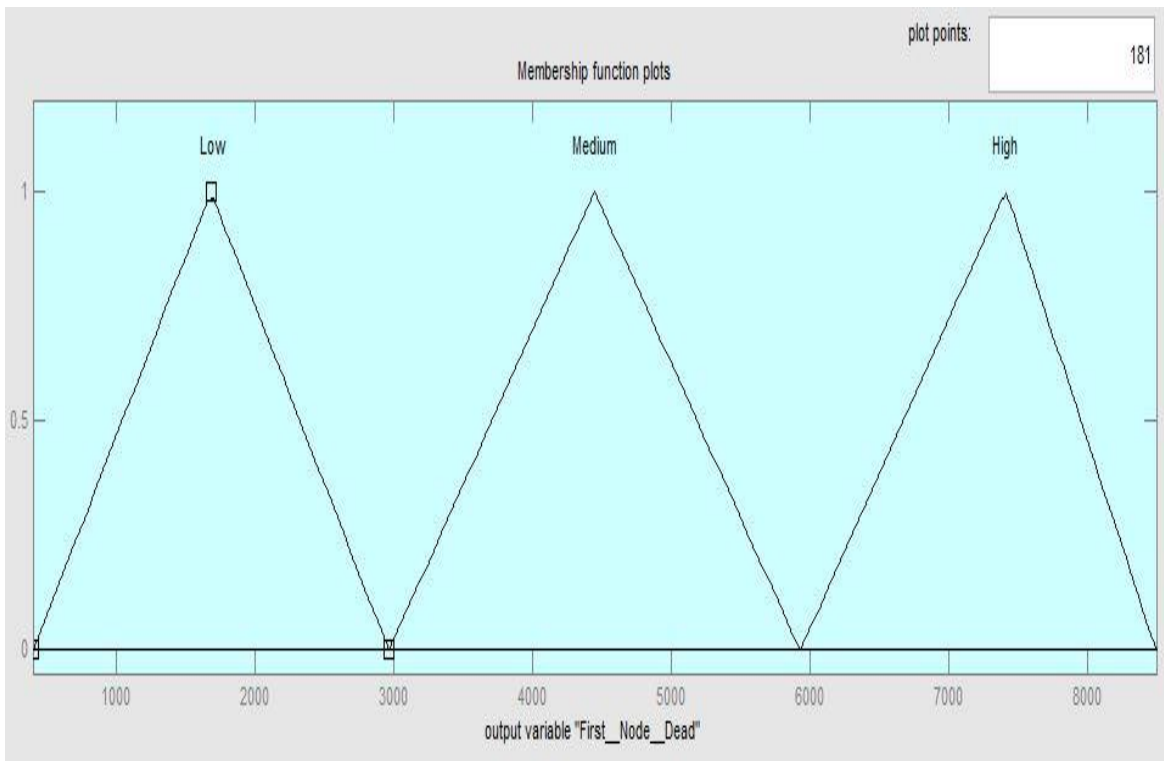

**Figure 7.7** Membership Function for First Node Dead

Figure 7.7 shows the membership function for the first node dead. The chances of first node dead from iteration 0 to 3000 are low, from 3000 to 5900 are medium and 5900 to 8500 are high.

### 7.2.2 Fuzzy Rules for First Node Dead

1. If (Nodes is Low) and (Energy is Low) then (First Node Dead is Low)
2. If (Nodes is Low) and (Energy is Medium) then (First Node Dead is Medium)
3. If (Nodes is Low) and (Energy is High) then (First Node Dead is High)
4. If (Nodes is Medium) and (Energy is Low) then (First Node Dead is Low)
5. If (Nodes is Medium) and (Energy is Medium) then (First Node Dead is Low)
6. If (Nodes is Medium) and (Energy is High) then (First Node Dead is Medium)
7. If (Nodes is High) and (Energy is Low) then (First Node Dead is Low)
8. If (Nodes is High) and (Energy is Medium) then (First Node Dead is Low)
9. If (Nodes is High) and (Energy is High) then (First Node Dead is Medium)

---

#### Proposed Algorithm 7.1

1.  $N \leftarrow$  Number of Sensor Nodes
  2. for  $j=1$  to  $N$
  3.      $N(j).E \leftarrow E_0$
  4.      $N(j).State \leftarrow$  Normal Node
  5. end for
  6.      $CH \leftarrow 0$
  7.      $N(i).P \leftarrow$  Assign Probability
  8.     while ( $CH \leq P\%$ )
  9.         Compute EI for  $N(i)$
  10.        Calculate Mean of EI
-

- 
11. Compute Thresh hold for N(j)
  12. Generate Random Number for N(j)
  13. if (RN < N(j).TH && CH < P%)
  14.     N(i) ← CH
  15.     CH++
  16. Add N(j) to Cluster Head List
  17. end if
- 

### 7.3 Experimental Results and Simulation Setup

Fuzzy logic has been used to analyze the lifetime and throughput of the network. Figure 7.8 to figure 7.11 shows the analysis of the proposed approach, after that proposed approach has also compared with existing fuzzy-based techniques.

#### 7.3.1 Simulation Scenario

Table 7.1 show the number of parameters have been taken to implement the proposed approach with existing approaches. Along with additional system hardware are core i5, windows 7 64 bit, 4 GB Ram, 2.1 GHz processor.

**Table 7.1** Simulation Parameters

S. No.	Parameter	Value
1	Area	100 M * 100 M
2	Nodes	50
3	Number of Iteration	2000
4	Position of Sink Node	50,50
5	Initial Energy of Nodes	.1 Joule
6	Simulation Tool	Matlab 2013

### 7.3.2 Analysis on Results

The proposed approach is analyzed in figure 7.8 to figure 7.11. Figure 7.8 shows the network lifetime in 3D. Network lifetime is considered as the first node of the network. Figure 7.9 to figure 7.11 shows the network throughput in 3D. Figure 7.12 shows the network lifetime, the proposed approach has compared with the existing two approaches (LAUCF and LEFUCMA). Figure 7.13 shows the throughput of the network, the proposed approach has compared with the existing two approaches (LAUCF and LEFUCMA).

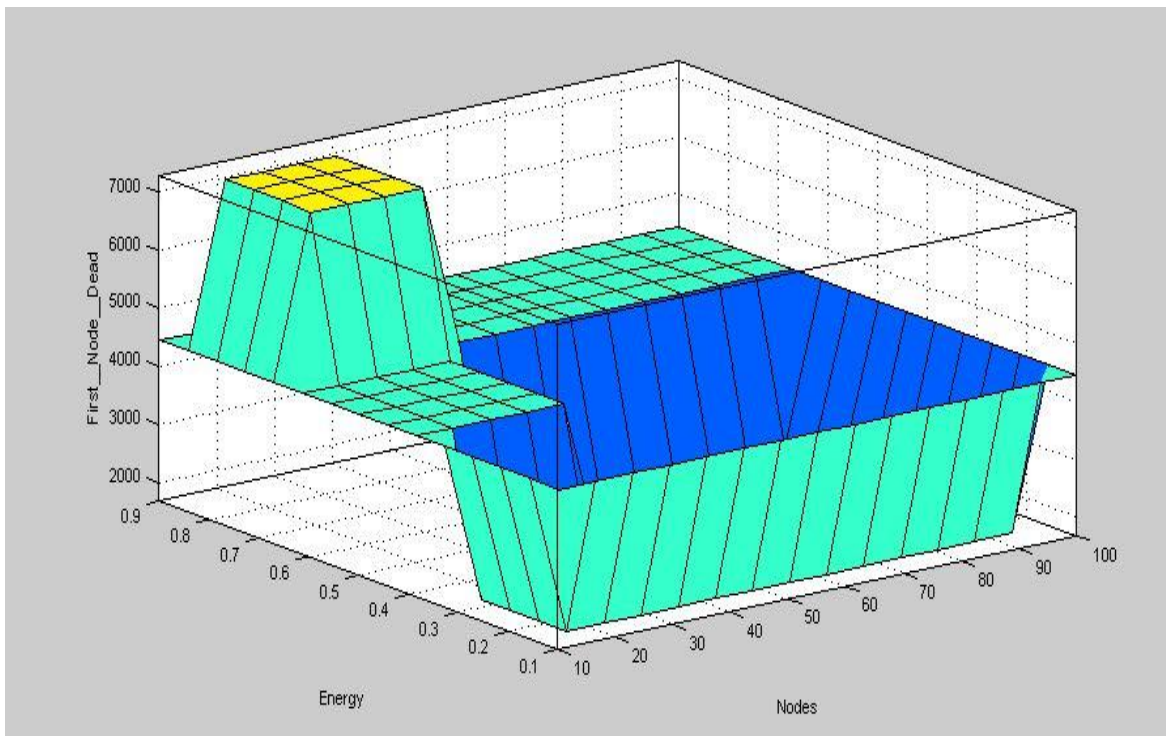

**Figure 7.8** First Node Dead

Figure 7.8 shows the first nodes dead. The x-axis represents the number of sensor nodes. Y-axis represents the initial energy of sensor nodes. Z-axis represents the first node dead.



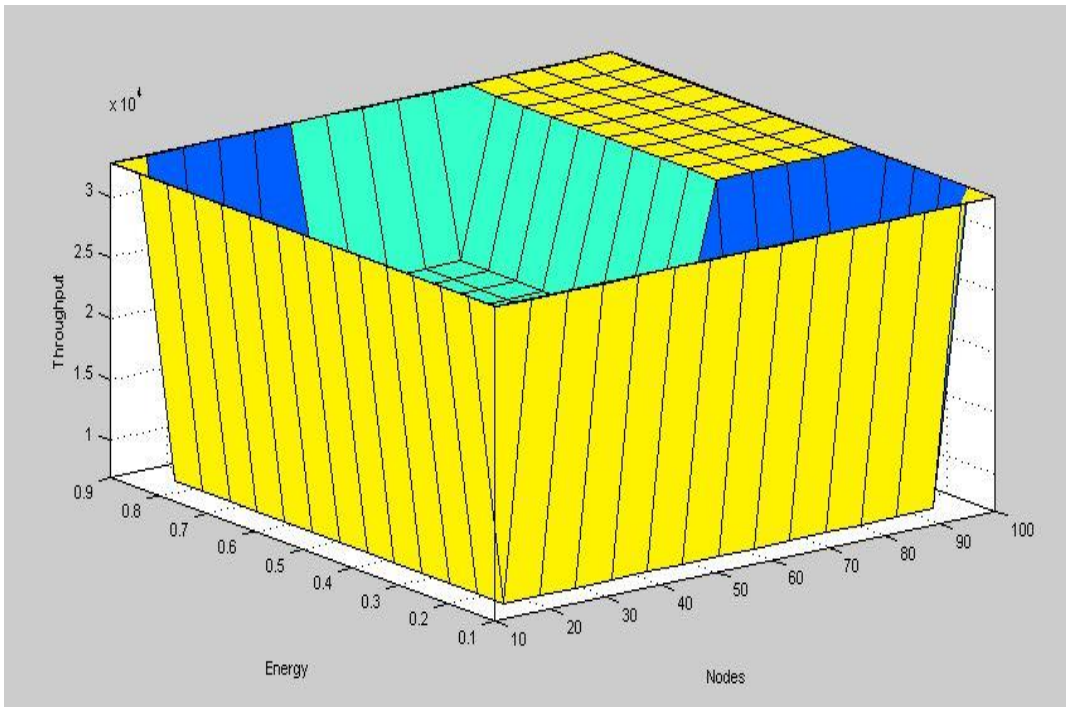

**Figure 7.9** Throughput of the Network

Figure 7.9 represents the Packets reached the sink node. The x-axis shows the number of sensor nodes. Y-axis represents the initial energy of sensor nodes. Z-axis represents the Number of Packets reached the sink node.

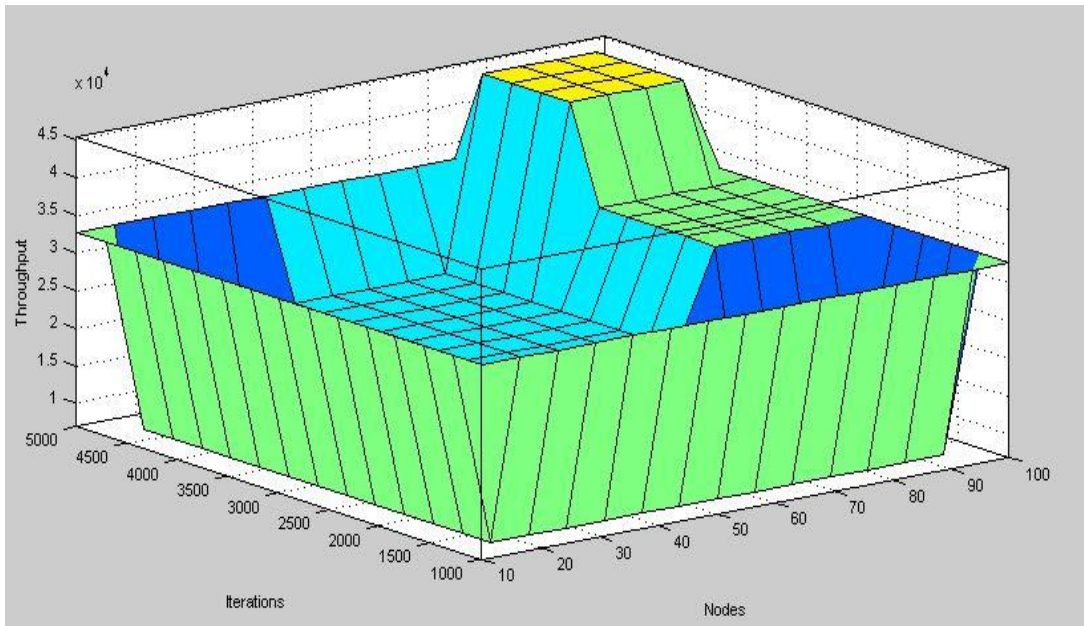

**Figure 7.10** NetworkThroughput

Figure 7.10 shows the Throughput of the Network. The x-axis represents the number of sensor nodes. Y-axis represents the number of iterations. Z-axis represents the Throughput of the Network.

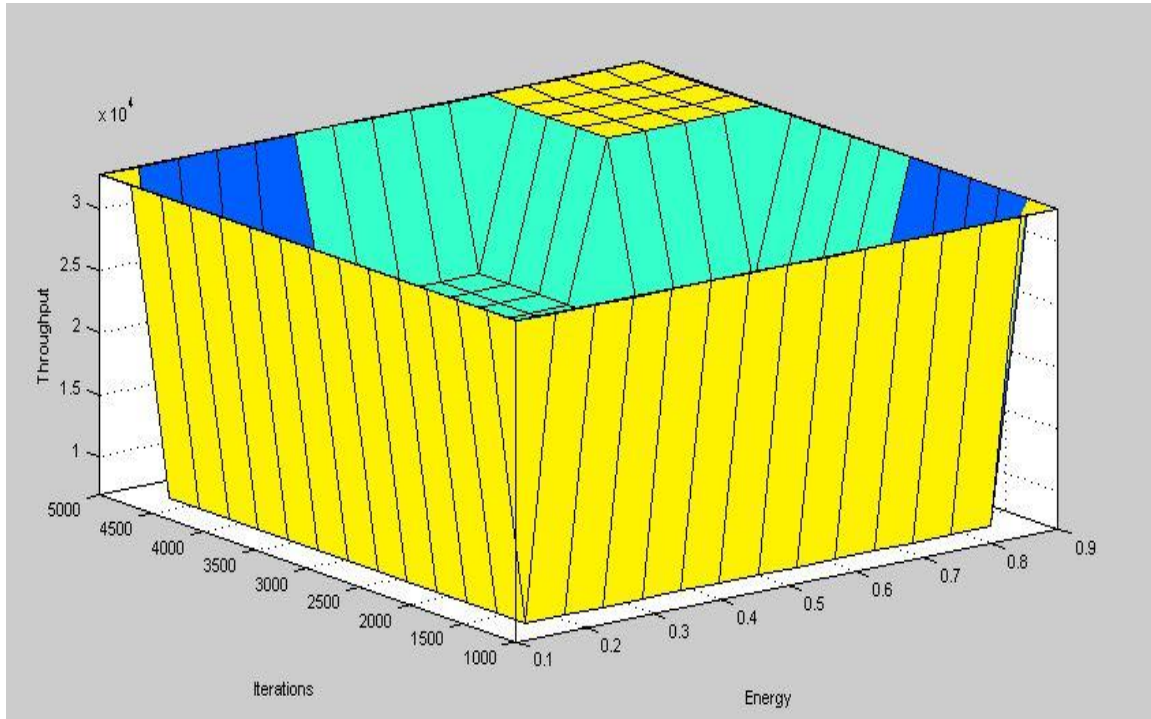

**Figure 7.11** NetworkThroughput

Figure 7.11 shows the Throughput of the Network. The x-axis shows the initial energy of sensor nodes. Y-axis represents the number of iterations. Z-axis represents the Throughput of the Network.

Figure 7.12 shows the number of alive nodes in the network. The x-axis represents the number of iterations. Y-axis represents the number of alive nodes. The proposed approach has a better network lifetime as compared to the existing approaches (LEFUCMA and LAUCF).

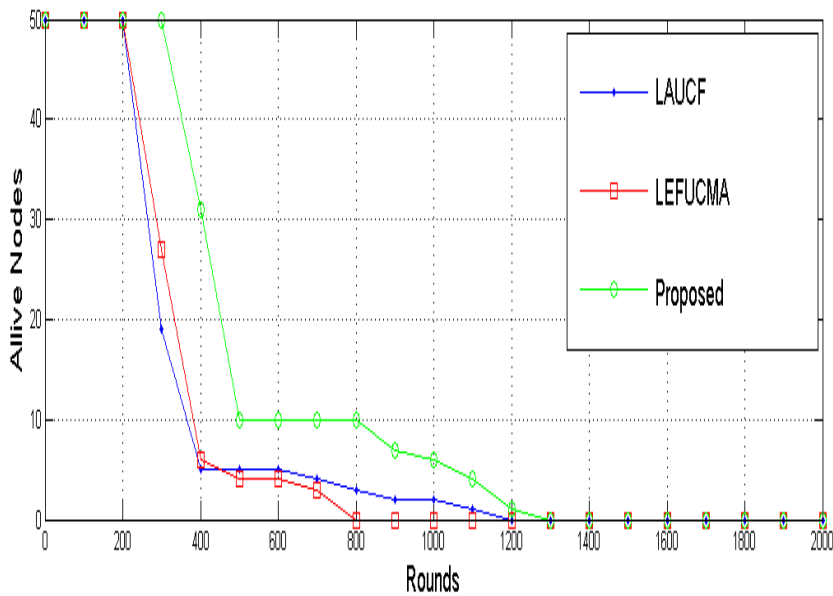

LAUCF [72]  
LEFUCMA[73]

Figure 7.12 Network Lifetime

Figure 7.13 shows the packets reached the base station. The x-axis represents the number of iterations. Y-axis represents the number of packets reached to the base station. The proposed approach has better network throughput as compared to the existing approaches (LEFUCMA and LAUCF).

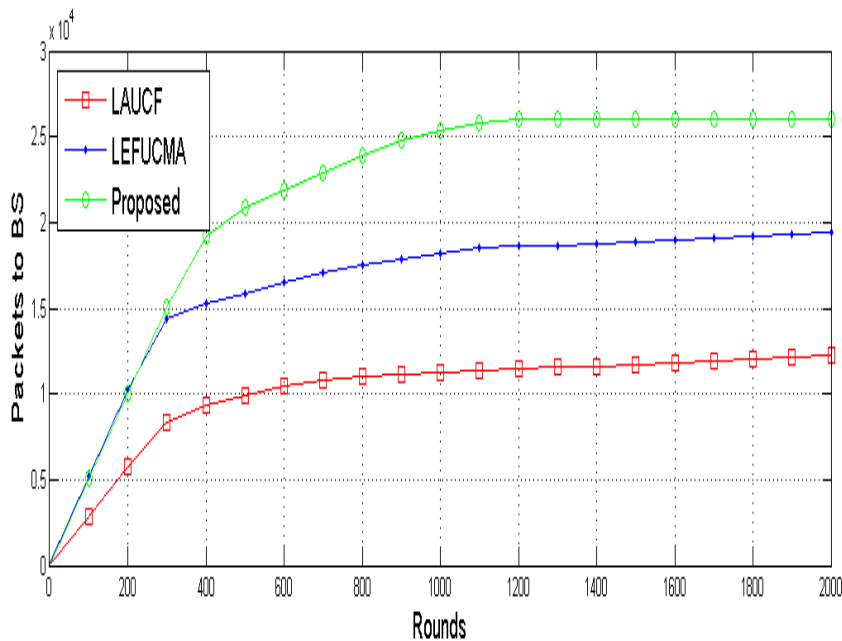

LAUCF [72]  
LEFUCMA[73]

Figure 7.13 Network Throughput

## **7.4 Summary**

Wireless sensor networks are used in many areas like weather forecasting, habitat monitoring, forest fire detection etc. The proposed approach is a fuzzy logic-based. The proposed approach is better 11.39 % in terms of network lifetime as a comparison of LEFUCMA and 34.27 % in terms of network lifetime as a comparison of LAUCF. The proposed approach is better 34.29 % in terms of network throughput as a comparison of LEFUCMA and 112.85 % in terms of network throughput as comparison LAUCF. In future fuzzy logic may be use to calculating the average energy consumption at every iteration and also may use for an end to end delay analysis

# CHAPTER 8

## CONCLUSION AND FUTURE SCOPE

### 8.1 Conclusion

Data aggregation and performance improvement have been mainly considered in this thesis. Lifetime, throughput, energy consumption and power consumption performance parameters have been considered. The main motto of the thesis was to improve the lifetime and throughput of the network & reduce energy consumption and power consumption. Chapter 1 represents the introduction of the thesis. A literature survey is presented in chapter 2. The literature survey is categorized into two categories. The literature survey is based on the data aggregation, based on the performance improvement and The data aggregation approach is proposed in chapter 3. The data aggregation approach is used to save transmission power. A hybrid approach is proposed to improve the lifetime of the network and network throughput in chapter 4. The hybrid approach is the combination of direct transmission and data transmission with cluster head. An approach is proposed to reduce the energy consumption in chapter 5. The fuzzy logic-based approach has been used to improve the lifetime of the network and network throughput in chapter 6. Two models are proposed in chapter 6 first one is for the network throughput and the second one is for the first node dead. The heterogeneity approach has been used to improve the lifetime of the network and network throughput in chapter 7.

The overall contribution of the thesis is the improvement of a lifetime and throughput of the network as well as to reduction in energy consumption and power consumption in the network. Network lifetime depends on the number of alive nodes. The time interval of the first node dead and simulation start is called network stability period. The time interval between first node dead and all node dead called instability period of the network. Network throughput is calculated as the number of packets reached the base station. The energy difference between start the simulation and end the simulation is called energy consumption.

## 8.2 Future Scope

Recently a lot of work is ongoing in the area of wireless sensor networks. This thesis has focused the research work based on performance parameters of the wireless sensor networks. In future researchers can work on the performance parameters like an end to end delay, latency, packet delivery ratio, etc. Data aggregation also can be done at the packet level. MAC protocol data unit and MAC service data unit are two data aggregation techniques for packet-level data aggregation. Wireless sensor networks have a number of issues like communication, event and periodic detection, data aggregation, specific destination, scalability, synchronization and performance of the network.

Data aggregation has been proposed approach in chapter 3 can be further used to calculate the packet delivery ratio and the goodput of the network. In future, data aggregation can also be done at the packet level. The hybrid approach which has used in chapter 4 can further extended to calculate the end to end delay and latency of the network. The hybrid approach is the combination of data transmission through direct and cluster head. The proposed approach two-tier based used in chapter 5 may explore to calculate the packet delivery ratio of the network.

## REFERENCES

- [1] Lin Y., Chang S., & Sun H., “CDAMA: concealed data aggregation scheme for multiple applications in wireless sensor networks”, *IEEE Transactions on Knowledge and Data Engineering*, 25 (7), pp 1471-1483, 2013.
- [2] Ren F., Zhang J., Wu Y., He T., Chen C., & Lin C., “ Attribute-aware data aggregation using potential-based dynamic routing in wireless sensor networks”, *IEEE transactions on parallel and distributed systems*, 24 (5), pp 881-892, 2013.
- [3] Campobello G., Serrano S., Galluccio L., & Palazzo S.,“ Applying the Chinese remainder theorem to data aggregation in wireless sensor networks”, *IEEE Communications Letters*, 17 (5), pp 1000-1003, 2013.
- [4] He J., Ji S., Pan Y., & Li Y.,“ Constructing load balanced data aggregation trees in probabilistic wireless sensor networks”, *IEEE Transactions on Parallel and Distributed Systems*, 25 (7), pp 1681-1690, 2014.
- [5] Roy S., Conti M., Setia S., & Jajodia S.,“Secure data aggregation in wireless sensor networks: Filtering out the attacker's impact”, *IEEE Transactions on Information Forensics and Security*, 9 (4), pp 681-694, 2014.
- [6] Bagaa M., Challal Y., Ksentini A., Derhab A., & Badache N., “Data aggregation scheduling algorithms in wireless sensor networks: Solutions and challenges”, *IEEE Communications Surveys & Tutorials*, 16 (3), pp 1339-1368, 2014.
- [7] Zhao C., Zhang W., Yang Y. & Yao S., “Treelet-based clustered compressive data aggregation for wireless sensor networks”, *IEEE Transactions on Vehicular Technology*, 64 (9), pp 4257-4267, 2015.
- [8] Wan S., Zhang Y. & Chen J., “On the Construction of Data Aggregation Tree With Maximizing Lifetime in Large-Scale Wireless Sensor Networks”, *IEEE Sensors Journal*, 16 (20), pp 7433-7440, 2016.
- [9] Sert S., Alchihabi, A., & Yazici, A., “A Two-Tier Distributed Fuzzy Logic Based Protocol for Efficient Data Aggregation in Multihop Wireless Sensor Networks”, *IEEE Transactions on Fuzzy Systems*, 26(6), 3615-3629, 2018.
- [10] Qin, Z., Wu, D., Xiao, Z., Fu, B., & Qin, Z., “Modeling and Analysis of Data Aggregation From Converge cast in Mobile Sensor Networks for Industrial IoT”, *IEEE Transactions on Industrial Informatics*, 14(10), 4457-4467, 2018.

- [11] Chen, Q., Gao, H., Cai, Z., Cheng, L., & Li, J., “Distributed Low-Latency Data Aggregation for Duty-Cycle Wireless Sensor Networks”, *IEEE/ACM Transactions on Networking (TON)*, 26(5), 2347-2360, 2018.
- [12] Wang, H., Xiong, Q., & Li, M., “Selection Cooperation Using Packet Aggregation With Equal Rate Feedback in Industrial Wireless Sensor Networks”, *IEEE Communications Letters*, 22(12), 2531-2534, 2018.
- [13] Zhang, J., Hu, P., Xie, F., Long, J., & He, A., “An Energy Efficient and Reliable In-Network Data Aggregation Scheme for WSN”, *IEEE Access*, 6, 71857-71870, 2018.
- [14] Nguyen, N. T., Liu, B. H., Chu, S. I., & Weng, H. Z., “Challenges, Designs, and Performances of a Distributed Algorithm for Minimum-Latency of Data-Aggregation in Multi-Channel WSNs”, *IEEE Transactions on Network and Service Management*, 16(1), 192-205, 2018.
- [15] Movva, P., & Rao, P. T., “Novel Two-Fold Data Aggregation and MAC Scheduling to Support Energy Efficient Routing in Wireless Sensor Network”, *IEEE Access*, 7, 1260-1274, 2018.
- [16] Wang, X., Zhou, Q., Gu, Y., & Tong, J., “Compressive Sensing-Based Data Aggregation Approaches for Dynamic WSNs”, *IEEE Communications Letters*, 23 (6), pp 1073-1076, 2019.
- [17] Tang, J., Zhang, B., Zhou, Y., & Wang, L., “An energy-aware spatial index tree for multi-region attribute query aggregation processing in wireless sensor networks”, *IEEE Access*, 5, pp 2080-2095, 2017.
- [18] Lin, H. C., & Chen, W. Y., “An approximation algorithm for the maximum-lifetime data aggregation tree problem in wireless sensor networks”, *IEEE Transactions on Wireless Communications*, 16(6), pp 3787-3798, 2017.
- [19] Kang, B., Nguyen, P. K. H., Zalyubovskiy, V., & Choo, H., “A distributed delay-efficient data aggregation scheduling for duty-cycled WSNs”, *IEEE Sensors Journal*, 17(11), pp 3422-3437, 2017.
- [20] Alinia, B., Hajiesmaili, M. H., Khonsari, A., & Crespi, N., “Maximum-quality tree construction for deadline-constrained aggregation in wsns”, *IEEE Sensors Journal*, 17(12), pp 3930-3943, 2017.



- [21] Ren, M., Li, J., Guo, L., Li, X., & Fan, W., “Distributed Data Aggregation Scheduling in Multi-Channel and Multi-Power Wireless Sensor Networks”, *IEEE Access*, 5, pp 27887-27896, 2017.
- [22] Nguyen, N. T., Liu, B. H., Pham, V. T., & Liou, T. Y., “An efficient minimum-latency collision-free scheduling algorithm for data aggregation in wireless sensor networks”, *IEEE Systems Journal*, 12(3), pp 2214-2225, 2018.
- [23] Akyurek, A. S., & Rosing, T. S., “Optimal packet aggregation scheduling in wireless networks”, *IEEE Transactions on Mobile Computing*, 17(12), pp 2835-2852, 2018.
- [24] Boubiche, S., Boubiche, D. E., Bilami, A., & Toral-Cruz, H., “Big data challenges and data aggregation strategies in wireless sensor networks”, *IEEE Access*, 6, pp 20558-20571, 2018.
- [25] Ming Lu Y. & WS Wong V., “An energy efficient multipath routing protocol for wireless sensor networks”, *International Journal of Communication Systems*, 20 (7), pp 747-766, 2007.
- [26] Tian D. & Georganas N., “A node scheduling scheme for energy conservation in large wireless sensor networks”, *Wireless Communications and Mobile Computing*, 3 (2), pp 271-290, 2003.
- [27] Alippi C., Anastasi G., Di Francesco M. & Roveri M., “Energy management in wireless sensor networks with energy-hungry sensors”, *IEEE Instrumentation & Measurement Magazine*, 12 (2), pp 16-23, 2009.
- [28] Chen Y., Liestman A. & Liu J., “A hierarchical energy-efficient framework for data aggregation in wireless sensor networks”, *IEEE Transactions on Vehicular Technology*, 55 (3), pp 789-796, 2006.
- [29] Rezaei Z. & Mobininejad S., “Energy saving in wireless sensor networks”, *International Journal of Computer Science and Engineering Survey*, 3 (1), pp 1 -23, 2012.
- [30] Lin C., Wu G., Xia F., Li M., Yao M. & Pei Z., “Energy efficient ant colony algorithms for data aggregation in wireless sensor networks”, *Journal of Computer and System Sciences*, 78 (6), pp 1686-1702, 2012.
- [31] Panigrahi C., Pati B., & Sarkar J., “CPDA: A conflict-free periodic data aggregation technique in wireless sensor networks”, *Egyptian Informatics Journal*, <https://doi.org/10.1016/j.eij.2016.06.005> ,2016.

- [32] Acharya S. & Tripathy C., “An ANFIS estimator based data aggregation scheme for fault tolerant Wireless Sensor Networks”, *Journal of King Saud University-Computer and Information Sciences*, 30 (3), pp 334-348, 2016.
- [33] Latha, A., Prasanna, S., Hemalatha, S., & Sivakumar, B., “A Harmonized Trust Assisted Energy Efficient Data Aggregation Scheme for Distributed Sensor Networks”, *Cognitive Systems Research*, 56, pp 14-22, 2019.
- [34] Dattatraya, K. N., & Rao, K. R., “Hybrid based cluster head selection for maximizing network lifetime and energy efficiency in WSN”, *Journal of King Saud University-Computer and Information Sciences*, <https://doi.org/10.1016/j.jksuci.2019.04.003> 2019.
- [35] G. S. Brar, S. Rani, V. Chopra, R. Malhotra, H. Song, & S. H. Ahmed, “Energy efficient direction-based PDORP routing protocol for WSN”, *IEEE Access*, 4, 3182-3194, 2016.
- [36] Yildiz, H. U., Gungor, V. C., & Tavli, B., “Packet size optimization for lifetime maximization in underwater acoustic sensor networks”, *IEEE Transactions on Industrial Informatics*, 15(2), pp 719-729, 2019.
- [37] Pavani M. ., & Rao, P. T., “Novel Two-Fold Data Aggregation and MAC Scheduling to Support Energy Efficient Routing in Wireless Sensor Network”, *IEEE Access*, 7, 1260-1274, 2018.
- [38] Dutt, S., Agrawal, S., & Vig, R., “Impact of Variable Packet Length on the Performance of Heterogeneous Multimedia Wireless Sensor Networks”, *Wireless Personal Communications*, 107 (4) pp 1849-1863, 2019.
- [39] Redhu, S., & Hegde, R. M., “Network lifetime improvement using landmark-assisted mobile sink scheduling for cyber-physical system applications”, *Ad Hoc Networks*, 87, pp 37-48, 2019.
- [40] Saranraj, G., Selvamani, K., & Kanagachidambaresan, G. R., “Optimal Energy-Efficient Cluster Head Selection (OEECHS) for Wireless Sensor Network”, *Journal of The Institution of Engineers (India): Series B*, <https://doi.org/10.1007/s40031-019-00390-3> , 2019.
- [41] Sharma, D., Ojha, A., & Bhondekar, A. P., “Heterogeneity consideration in wireless sensor networks routing algorithms: a review”, *The Journal of Supercomputing*, 75 (5) pp 2341-2394, 2019.

- [42] Heinzelman, W. R., Chandrakasan, A., & Balakrishnan, H., “Energy-efficient communication protocol for wireless microsensor networks”, In System Sciences, Proceedings of the 33rd annual Hawaii international conference (pp. 1-10). IEEE, 2000.
- [43] Handy, M. J., Haase, M., & Timmermann, D., “Low energy adaptive clustering hierarchy with deterministic cluster-head selection”, 4th International Workshop on Mobile and Wireless Communications Network, (pp. 368-372). IEEE, 2002.
- [44] Younis, O., & Fahmy, S., “HEED: a hybrid, energy-efficient, distributed clustering approach for ad hoc sensor networks”, IEEE Transactions on mobile computing, 3(4), pp 366-379, 2004.
- [45] Smaragdakis, G., Matta, I., & Bestavros, A., “SEP: A stable election protocol for clustered heterogeneous wireless sensor networks”, Boston University Computer Science Department, pp 1-11, 2004.
- [46] Qing, L., Zhu, Q., & Wang, M., “Design of a distributed energy-efficient clustering algorithm for heterogeneous wireless sensor networks”, Computer communications, 29(12), pp 2230-2237, 2006.
- [47] Kim, J. M., Park, S. H., Han, Y. J., & Chung, T. M., “CHEF: cluster head election mechanism using fuzzy logic in wireless sensor networks”, 10th international conference on Advanced communication technology, ICACT 2008. (Vol. 1, pp. 654-659). IEEE, 2008.
- [48] Taheri, H., Neamatollahi, P., Younis, O. M., Naghibzadeh, S., & Yaghmaee, M. H., “An energy-aware distributed clustering protocol in wireless sensor networks using fuzzy logic”, Ad Hoc Networks, 10(7), pp 1469-1481, 2012.
- [49] Dahnil, D. P., Singh, Y. P., & Ho, C. K., “Topology-controlled adaptive clustering for uniformity and increased lifetime in wireless sensor networks”, IET Wireless Sensor Systems, 2(4), pp 318-327, 2012.
- [50] Bagci, H., & Yazici, A., “An energy aware fuzzy approach to unequal clustering in wireless sensor networks”, Applied Soft Computing, 13(4), pp 1741-1749, 2013.
- [51] Salim, A., Osamy, W., & Khedr, A. M., “IBLEACH: intra-balanced LEACH protocol for wireless sensor networks”, Wireless networks, 20(6), pp 1515-1525, 2014.
- [52] Kim, J. Y., Sharma, T., Kumar, B., Tomar, G. S., Berry, K., & Lee, W. H., “Inter cluster ant colony optimization algorithm for wireless sensor network in dense

- environment”, *International Journal of distributed sensor networks*, 10(4), pp 407-452, 2014.
- [53] Tarhani, M., Kavian, Y. S., & Siavoshi, S., “SEECH: Scalable energy efficient clustering hierarchy protocol in wireless sensor networks”, *IEEE Sensors Journal*, 14(11), pp 3944-3954, 2014.
- [54] Jia, D., Zhu, H., Zou, S., & Hu, P., “Dynamic cluster head selection method for wireless sensor network”, *IEEE Sensors Journal*, 16(8), pp 2746-2754, 2016.
- [55] Balakrishnan, B., & Balachandran, S., “FLECH: fuzzy logic based energy efficient clustering hierarchy for non uniform wireless sensor networks”, *Wireless Communications and Mobile Computing*, pp 1-13, 2017.
- [56] Zhou, Y., Wang, N., & Xiang, W., “Clustering hierarchy protocol in wireless sensor networks using an improved PSO algorithm”, *IEEE Access*, 5, pp 2241-2253, 2017.
- [57] Singh, S., Chand, S., Kumar, R., Malik, A., & Kumar, B., “NEECP: Novel energy-efficient clustering protocol for prolonging lifetime of WSNs”, *IET Wireless Sensor Systems*, 6(5), pp 151-157, 2016.
- [58] Tabatabaei, S., Rajaei, A. & Rigi, A.M. *Wireless Personal Communication* (2019). <https://doi.org/10.1007/s11277-019-06497-6>
- [59] Robinson Y. H., Julie E.G., Balaji S. and Ayyasamy A., “Energy aware clustering scheme in wireless sensor network using neuro-fuzzy approach”, *Wireless Personal Communications*, 95(2), pp 703-721, 2017.
- [60] Jain A., and Reddy B. R., “A novel method of modeling wireless sensor network using fuzzy graph and energy efficient fuzzy based k-hop clustering algorithm. *Wireless Personal Communications*, 82(1), pp 157-181, 2015.
- [61] Koosheshi K. and Ebadi S., “Optimization energy consumption with multiple mobile sinks using fuzzy logic in wireless sensor networks”, *Wireless Networks*, 25 (3), pp 1215-1234, 2019.
- [62] Mao S., Zhao C., Zhou Z., Ye Y., “An improved fuzzy unequal clustering algorithm for wireless sensor network”, *Mobile Networks and Applications*, 18(2), pp 206-214, 2013.
- [63] Mirzaie M. and Mazinani S. M., “MACHFL-FT: a fuzzy logic based energy-efficient protocol to cluster heterogeneous nodes in wireless sensor networks”, *Wireless Networks*, 25 (8), pp 4597-4609, 2019.

- [64] Neamatollahi P. and Naghibzadeh M., “Distributed unequal clustering algorithm in large-scale wireless sensor networks using fuzzy logic”, *The Journal of Supercomputing*, 74(6), pp 2329-2352, 2018.
- [65] Nokhanji N., Hanapi Z. M., Subramaniam S., Mohamed M. A., “An energy aware distributed clustering algorithm using fuzzy logic for wireless sensor networks with non-uniform node distribution”, *Wireless Personal Communications*, 84(1), pp 395-419, 2015.
- [66] Ortiz A.M., Royo F., Olivares T., Castillo J.C., Orozco-Barbosa L., Marron P. J., “Fuzzy-logic based routing for dense wireless sensor networks”, *Telecommunication Systems*, 52(4), pp 2687-2697, 2013.
- [67] Phoemphon S., So-In C., Nguyen T.G., “An enhanced wireless sensor network localization scheme for radio irregularity models using hybrid fuzzy deep extreme learning machines”, *Wireless Networks*, 24(3), pp 799-819, 2018.
- [68] Sharma G., Kumar A., “Fuzzy logic based 3D localization in wireless sensor networks using invasive weed and bacterial foraging optimization”, *Telecommunication Systems*, 67(2), pp 149-162, 2018.
- [69] Baccar N. and Bouallegue R., “Interval type 2 fuzzy localization for wireless sensor networks”, *EURASIP Journal on Advances in Signal Processing*, 42(1), pp 1-13, 2016.
- [70] Abdolmaleki N., Ahmadi M., Malazi H.T. and Milardo S., “Fuzzy topology discovery protocol for SDN-based wireless sensor networks”, *Simulation Modelling Practice and Theory*, 79, pp 54-68, 2017.
- [71] Adhikary D.R.D and Mallick D. K., “A congestion aware, energy efficient, on demand fuzzy logic based clustering protocol for multi-hop wireless sensor networks”, *Wireless Personal Communications*, 97(1), pp 1445-1474, 2017.
- [72] Dutta R., Gupta S., Das M.K., “Low-energy adaptive unequal clustering protocol using fuzzy c-means in wireless sensor networks”, *Wireless personal communications*, 79(2), pp 1187-1209, 2014.
- [73] Gajjar S., Sarkar M., Dasgupta K. and Chaniyara D., “Low Energy Fuzzy based Unequal Clustering Multihop Architecture for Wireless Sensor Networks” *Proceedings of the National Academy of Sciences, India Section A: Physical Sciences*, 88 (4), pp 539-556, 2018.

- [74] Julie E. G. and Tamilselvi S., “CDS-Fuzzy opportunistic routing protocol for wireless sensor networks”, *Wireless Personal Communications*, 90(2), pp 903-922, 2016.
- [75] Ouchitachen, H., Hair, A., &Idrissi, N., “Improved multi-objective weighted clustering algorithm in Wireless Sensor Network”, *Egyptian Informatics Journal*, 18(1), pp 45-54, 2017.
- [76] Ren, J., Zhang, Y., Zhang, K., Liu, A., Chen, J., &Shen, X. S., “Lifetime and energy hole evolution analysis in data-gathering wireless sensor networks”, *IEEE transactions on industrial informatics*, 12(2), pp 788-800, 2016.
- [77] Long, J., Dong, M., Ota, K., & Liu, A., “A Green TDMA Scheduling algorithm for prolonging lifetime in wireless sensor networks”, *IEEE Systems Journal*, 11(2), pp 868-877, 2017.
- [78] Nayak, P., &Devulapalli, A., “A fuzzy logic-based clustering algorithm for WSN to extend the network lifetime. *IEEE sensors journal*, 16(1), pp 137-144, 2016.
- [79] Pananjady, A., Bagaria, V. K., &Vaze, R., “Optimally approximating the coverage lifetime of wireless sensor networks”, *IEEE/ACM Transactions on Networking*, 25(1), pp 98-111, 2017.
- [80] Zhou, F., Chen, Z., Guo, S., & Li, J., “Maximizing lifetime of data-gathering trees with different aggregation modes in WSNs”, *IEEE Sensors Journal*, 16(22), pp 8167-8177, 2016.
- [81] Fei, Z., Li, B., Yang, S., Xing, C., Chen, H., &Hanzo, L., “A survey of multi-objective optimization in wireless sensor networks: Metrics, algorithms, and open problems”, *IEEE Communications Surveys & Tutorials*, 19(1), pp 550-586, 2017.
- [82] Sun, Y., Dong, W., & Chen, Y., “An improved routing algorithm based on ant colony optimization in wireless sensor networks”, *IEEE Communications Letters*, 21(6), pp 1317-1320, 2017.
- [83] Dietrich, I., & Dressler, F., “On the lifetime of wireless sensor networks”, *ACM Transactions on Sensor Networks (TOSN)*, 5(1), 1-38, 2009.
- [84] Sappidi, R., Girard, A., & Rosenberg, C., “Maximum achievable throughput in a wireless sensor network using in-network computation for statistical functions”, *IEEE/ACM Transactions on Networking (TON)*, 21(5), 1581-1594, 2013.

- [85] Tomar G.S., Sharma T., and Kumar B., “Fuzzy based ant colony optimization approach for wireless sensor network”, *Wireless Personal Communications*, 84(1), pp 361-375, 2015.
- [86] Toloueiashtian M. and Motameni H., “A new clustering approach in wireless sensor networks using fuzzy system”, *The Journal of Supercomputing*, 74(2), pp 717-737, 2018.
- [87] Tam N. T. and Hai D. T., “Improving lifetime and network connections of 3D wireless sensor networks based on fuzzy clustering and particle swarm optimization”, *Wireless Networks*, 24(5), pp 1477-1490, 2018.
- [88] Tamandani Y. K. and Bokhari M. U., “SEPFL routing protocol based on fuzzy logic control to extend the lifetime and throughput of the wireless sensor network”, *Wireless networks*, 22(2), pp 647-653, 2016.
- [89] Sureshkumar A. and Ravindran R.S., “Swarm and fuzzy based cooperative caching framework to optimize energy consumption over multimedia wireless sensor networks”, *Wireless Personal Communications*, 90(2), pp 961-984, 2016.
- [90] Nguyen N. T., Liu B. H., Pham V. T and Luo Y. S., “On maximizing the lifetime for data aggregation in wireless sensor networks using virtual data aggregation trees”, *Computer Networks*, 105, pp99-110, 2016.
- [91] Bhasker L., “Genetically derived secure cluster-based data aggregation in wireless sensor networks”, *IET Information Security*, 8(1), pp1-7, 2014.
- [92] Sasirekha S. and Swamynathan S., “Cluster-chain mobile agent routing algorithm for efficient data aggregation in wireless sensor network”, *Journal of Communications and Networks*, 19(4), 392-401, 2017.
- [93] Lalitha K., Thangarajan R., Udgata S. K, Poongodi C. and Sahu A. P., “GCCR: An Efficient Grid Based Clustering and Combinational Routing in Wireless Sensor Networks”, *Wireless Personal Communications*, 97(1), 1075-1095, 2017.

## LIST OF PUBLICATIONS

### Journals (Published)

- H. Kumar, P. K. Singh, “Node Energy Based Approach to Improve Network Lifetime and Throughput in Wireless Sensor Networks”, Journal of Telecommunication, Electronic and Computer Engineering, e-ISSN: 2289-8131 Vol. 9 No. 3-6, pp 83-88, 2017.(**Scopus**)
- H. Kumar, P. K. Singh, “Power Transmission Analysis in Wireless Sensor Networks Using Data Aggregation Techniques”, International Journal of Information System Modeling and Design, 9,(4), 49-66, 2018. (**ESCI, Scopus**)
- H. Kumar, P. K. Singh, “Average Energy Analysis in Wireless Sensor Networks Using Multitier Architecture”, International Journal of Performability Engineering, 15, (4), 1199-1208, 2019. (**Scopus**)
- H. Kumar, P. K. Singh, “Network Lifetime and Throughput Analysis in Wireless Sensor Networks Using Fuzzy Logic”, Recent Advances in Electrical and Electronic Engineering, 13 (2), 227-235, 2020. (**ESCI, Scopus**)

### Journals (Under Review)

- H. Kumar, P. K. Singh, “Enhancing Network lifetime and Throughput in Heterogeneous Wireless Sensor Networks”, Wireless Personal Communications, 2019. (**SCIE, Scopus**)  
(**Under Review**)

### Conferences

- H. Kumar, P. K. Singh, “Analyzing Data Aggregation in Wireless Sensor Networks”, 4th International Conference on Computing for Sustainable Global Development INDIACom, 4024-4029, 2017. (**Scopus**)
- H. Kumar, P. K. Singh, “Comparison and Analysis on Artificial Intelligence Based Data Aggregation Techniques in Wireless Sensor Networks”, International Conference on Computational Intelligence and Data Science, 498-506, 2018.(**Scopus**)



## Other Conferences

- H. Kumar, P. K. Singh, “Study on Wireless Sensor Networks and its Applications”, 3<sup>rd</sup> Himachal Pradesh Science Congress, 2018. **(Accepted and Presented)**
- H. Kumar, P. K. Singh, “Power Transmission Analysis in Wireless Sensor Networks Using Data Aggregation Techniques”, 2<sup>nd</sup> International Conference on Innovations in Computing, 2018. **(Accepted and Presented)**